



**Bethania Silver Project – NI 43-101 Technical Report  
(Preliminary Economic Assessment prepared for Kuya Silver  
Corporation)  
Huancavelica, Peru**

**Qualified Persons:**

Edgard Vilela, (MAusIMM (CP)  
Scott Jobin-Bevans (P.Ge)  
Simon Mortimer (P.Ge)  
Donald Hickson, (P.Eng.)  
Laurie Tahija, (MMSA)  
John Woodson, (P.E.)

**Effective Date: April 9, 2022**

**Report Date: June 13, 2022**

**CERTIFICATE OF QUALIFIED PERSON**  
**Scott Jobin-Bevans (PhD, P.Geo.)**

I, Scott Jobin-Bevans (P.Geo.), do hereby certify that:

1. I am an independent consultant of Caracle Creek International Consulting Inc. (Caracle) and have an address at Av. Hacienda Macul 6047, Peñalolen, Santiago, Chile.
2. This certificate applies to the technical report titled “Bethania Silver Project – NI 43-101 Technical Report, (Preliminary Economic Assessment prepared for Kuya Silver Corporation), Huancavelica, Peru” that has an effective date of 09 April 2022 (the “technical report”). (“Technical Report”).
3. I graduated from the University of Manitoba (Winnipeg, Manitoba) with a B.Sc. Geosciences (Hons) in 1995 and from the University of Western Ontario (London, Ontario) with a Ph.D. (Geology) in 2004.
4. I am a member, in good standing, of Association of Professional Geoscientists of Ontario, License Number 0183 (since June 2002).
5. I have practiced my profession continuously for more than 20 years, having worked mainly in mineral exploration but also having experience in mine site geology, mineral resource and reserve estimations, preliminary economic assessments, pre-feasibility studies, due diligence, valuation, and evaluation reporting. I have authored, co-authored, or contributed to numerous NI-43-101 reports on a multitude of commodities including nickel-copper-platinum group elements, base metals, gold, silver, vanadium, and lithium projects in Canada, the United States, China, Central and South America, Europe, Africa, and Australia.
6. I have read the definition of “Qualified Person” set out in National Instrument 43-101 Standards of Disclosure for Mineral Projects (“NI 43-101”) and certify that by reason of my education, affiliation with a professional association (as defined in NI 43-101) and past relevant work experience, I fulfill the requirements to be a “Qualified Person” for the purposes of NI 43-101.
7. I am responsible for the preparation of sections 7, 8, 9, 10, 11 and 12.
8. I visited the Bethania Silver Project on 15 June 2019.
9. I am independent of Kuya Silver Corporation applying all of the tests in Section 1.5 of NI 43-101 Form 43-101F1 and Companion Policy 43-101CP.
10. I am an independent geological consultant with Caracle Creek International Consulting Inc. who are providing independent geological consulting services to Kuya Silver Corporation on the Bethania Silver Project.
11. I have read NI 43-101, Form 43-101F1 and confirm the Technical Report has been prepared in compliance with that instrument and form.
12. As of the Effective Date of the Technical Report, to the best of my knowledge, information and belief, the Sections of the Technical Report for which I am responsible contain all scientific and technical information that is required to be disclosed to make the Technical Report not misleading.

Dated: June 13, 2022

*“Signed”*

---

Scott Jobin-Bevans (PhD., PMP, P.Geo.)

**CERTIFICATE OF QUALIFIED PERSON**  
**Simon James Atticus Mortimer (MSc., FAIG)**

I, Simon James Atticus Mortimer (MSc., FAIG), do hereby certify that:

1. I am a professional geologist with Atticus Geoscience Consulting S.A.C. with an address at Ramon Zavala 420, Miraflores, Lima, Peru.
2. This certificate applies to the technical report titled “Bethania Silver Project – NI 43-101 Technical Report, (Preliminary Economic Assessment prepared for Kuya Silver Corporation), Huancavelica, Peru” that has an effective date of 09 April 2022 (the “technical report”). (“Technical Report”).
3. I graduated from the University of St. Andrews, Scotland, with a B. Sc. in Geoscience in 1995 and from the Camborne School of Mines with a MSc. in Mining Geology in 1998.
4. I am a Registered Professional Geoscientist (P. Geo.), Practicing, as a member of the Australasian Institute of Mining and Metallurgy (#300947) and the Australian Institute of Geoscientists (FAIG #7795).
5. I have worked as a geoscientist in the minerals industry for over 20 years and I have been directly involved in the mining, exploration, and evaluation of mineral properties mainly in Peru, Chile, Argentina, Brazil, and Colombia for precious and base metals.
6. I have read the definition of “Qualified Person” set out in National Instrument 43-101 Standards of Disclosure for Mineral Projects (“NI 43-101”) and certify that by reason of my education, affiliation with a professional association (as defined in NI 43-101) and past relevant work experience, I fulfill the requirements to be a “Qualified Person” for the purposes of NI 43-101.
7. I am responsible for the preparation of sections 14, 25.1 and 26.1.
8. I visited the Bethania Silver Project on 24 to 27 May 2021.
9. I am independent of Kuya Silver Corporation applying all of the tests in Section 1.5 of NI 43-101 Form 43-101F1 and Companion Policy 43-101CP.
10. I am an independent geological consultant assisting Caracle Creek International Consulting Inc. who are providing independent geological consulting services to Kuya Silver Corporation on the Bethania Silver Project.
11. I have read NI 43-101, Form 43-101F1 and confirm the Technical Report has been prepared in compliance with that instrument and form.
12. As of the Effective Date of the Technical Report, to the best of my knowledge, information and belief, the Sections of the Technical Report for which I am responsible contain all scientific and technical information that is required to be disclosed to make the Technical Report not misleading.

Dated: June 13, 2022

*“Signed”*

---

Simon James Atticus Mortimer (MSc. ACSM, MAusIMM, FAIG)

**CERTIFICATE OF QUALIFIED PERSON**  
**Edgard Vilela, MAusIMM (CP)**

1. I, Edgard Vilela, MAusIMM (CP), am employed as a Principal Mining Consultant with Mining Plus Peru S.A.C. (Mining Plus), with an office address at Avenida Jose Pardo 513, Office 1001, Miraflores, Lima, Peru.
2. This certificate applies to the technical report titled “Bethania Silver Project – NI 43-101 Technical Report, (Preliminary Economic Assessment prepared for Kuya Silver Corporation), Huancavelica, Peru” that has an effective date of 09 April 2022 (the “technical report”). (“Technical Report”).
3. I am a Chartered Professional with the Australasian Institute of Mining and Metallurgy (MAusIMM(CP) #992615),. I graduated from the Pontificia Universidad Católica del Perú with a degree in Mining Engineering in the year 2000.
4. I have practiced my profession for 22 years. I have been directly involved in multiple underground projects both as the corporate manager of technical services for Fortuna Silver Mines, and the corporate Manager of Reserves for Volcan.
5. As a result of my experience and qualifications, I am a Qualified Person as defined in National Instrument 43–101 Standards of Disclosure for Mineral Projects (NI 43–01) for those sections of the technical report that I am responsible for preparing.
6. I have visited the Project site on the 25 of January 2022.
7. I am responsible for Sections 1, 2, 3, 4, 5, 6, 15, 16, 18.1, 19, 20, 21 (except 21.5, 21.6 and 21.10), 22, 23, 24, 25.2, 25.4 to 25.6, 26.2, 26.4, and 27.
8. I am independent of the issuer applying all of the tests in section 1.5 of National Instrument 43-101.
9. I have not had prior involvement with the property that is the subject of the Technical Report.
10. I have read NI 43–101 and the sections of the technical report for which I am responsible have been prepared in compliance with that Instrument.
11. As of the effective date of the technical report, to the best of my knowledge, information and belief, the sections of the technical report for which I am responsible contain all scientific and technical information that is required to be disclosed to make the technical report not misleading.

Dated: June 13, 2022

*“Signed”*

---

Edgard Vilela, MAusIMM (CP)

**CERTIFICATE OF QUALIFIED PERSON**  
**Donald Hickson, P.Eng.**

1. I, Donald Hickson, P.Eng., am employed as the Managing Partner, Tailings and Mine Waste, Envis E.I.R.L., with an office address at Calle German Aparicio Gomez Sanchez 320, Miraflores, Lima, Peru.
2. This certificate applies to the technical report titled “Bethania Silver Project – NI 43-101 Technical Report, (Preliminary Economic Assessment prepared for Kuya Silver Corporation), Huancavelica, Peru” that has an effective date of 09 April 2022 (the “technical report”). (“Technical Report”).
3. I am a Professional Engineer of Alberta, Canada. I graduated from the University of Waterloo (Canada) with a B.A.Sc. in 1991.
4. I have practiced my profession for 30 years. I am considered to be a subject matter expert at an international level for the review and design of tailings facilities. My experience includes roles as Engineer-of-Record on mid- and major-size tailings facilities, Dam Safety Review, as well as Expert and 3rd-Party Independent Review. I have been directly involved in tailings and infrastructure-related aspects of the project.
5. As a result of my experience and qualifications, I am a Qualified Person as defined in National Instrument 43–101 Standards of Disclosure for Mineral Projects (NI 43– 01) for those sections of the technical report that I am responsible for preparing.
6. I have not visited the Bethania Project site.
7. I am responsible for Sections 18.2, 21.6, 21.12 and 26.5.
8. I am independent of the issuer applying all of the tests in section 1.5 of National Instrument 43-101.
9. I have not had prior involvement with the property that is the subject of the Technical Report.
10. I have read NI 43–101 and the sections of the technical report for which I am responsible have been prepared in compliance with that Instrument.
11. As of the effective date of the technical report, to the best of my knowledge, information and belief, the sections of the technical report for which I am responsible contain all scientific and technical information that is required to be disclosed to make the technical report not misleading.

Dated: June 13, 2022

“Signed”

---

Donald Hickson, P.Eng.

**CERTIFICATE OF QUALIFIED PERSON**  
**Laurie M. Tahija, Q.P. (MMSA)**

I, Laurie M. Tahija, Q.P., do hereby certify that:

1. I am currently employed as Senior Vice President at M3 Engineering & Technology Corp. located at 2051 West Sunset Rd, Suite 101, Tucson, AZ 85704.
2. This certificate applies to the technical report titled “Bethania Silver Project – NI 43-101 Technical Report, (Preliminary Economic Assessment prepared for Kuya Silver Corporation), Huancavelica, Peru” that has an effective date of 09 April 2022 (the “technical report”). (“Technical Report”).
3. I am a graduate of Montana College of Mineral Science and Technology, in Butte, Montana and received a Bachelor of Science degree in Mineral Processing Engineering in 1981.
4. I am recognized as a Qualified Professional (QP) member (#01399QP) with special expertise in Metallurgy/Processing by the Mining and Metallurgical Society of America (MMSA).
5. I have practiced mineral processing for 40 years. I have over twenty (20) years of plant operations and project management experience at a variety of mines including both precious metals and base metals. I have worked both in the United States (Nevada, Idaho, California) and overseas (Papua New Guinea, China, Chile, Mexico) at existing operations and at new operations during construction and startup. My operating experience in precious metals processing includes heap leaching, agitation leaching, gravity, flotation, Merrill-Crowe, and ADR (CIC & CIL). My operating experience in base metal processing includes copper heap leaching with SX/EW and zinc recovery using ion exchange, SX/EW, and casting. I have been responsible for process design for new plants and the retrofitting of existing operations. I have been involved in projects from construction to startup and continuing into operation. I have worked on scoping, pre-feasibility and feasibility studies for mining projects in the United States and Latin America, as well as worked on the design and construction phases of some of these projects.
6. I have read the definition of “qualified person” set out in National instrument 43-101 (“NI 43-101”) and certify that by reason of my education, affiliation with a professional association (as defined in NI 43-101) and past relevant work experience, I fulfill the requirements to be a “qualified person” for the purposes of NI 43-101.
7. I am responsible for Sections 13, 17, 25.3 and 26.3.
8. I have not visited the Bethania Project site.
9. As of the date of this certificate, to the best of my knowledge, information and belief, the Technical Report contains all scientific and technical information required to be disclosed to make the report not misleading.
10. I am independent of the issuer applying all of the tests in section 1.5 of National Instrument 43-101.
11. I have not had prior involvement with the property that is the subject of the Technical Report.
12. I have read the National Instrument 43-101 and Form 43-101F1. The sections of the Technical Report that I am responsible for have been prepared in compliance with that instrument and form.
13. As of the effective date of the technical report, to the best of my knowledge, information and belief, the sections of the technical report for which I am responsible contain all scientific and technical information that is required to be disclosed to make the technical report not misleading.

14. I consent to the filing of the Technical Report with any stock exchange and other regulatory authority and any publication by them, including electronic publication in the public company files on their website accessible by the public, of the Technical Report.

Dated: June 13, 2022

“Signed”

---

Laurie M. Tahija, Q.P. (MMSA)

**CERTIFICATE OF QUALIFIED PERSON**  
**John W. Woodson, P.E.**

I, John W. Woodson, P.E., do hereby certify that:

1. I am employed as Chief Financial Officer, Senior Vice President, and Project Manager of M3 Engineering and Technology Corporation, 2051 W. Sunset Rd., Ste. 101, Tucson, AZ 85704, U.S.A.
2. This certificate applies to the technical report titled “Bethania Silver Project – NI 43-101 Technical Report, (Preliminary Economic Assessment prepared for Kuya Silver Corporation), Huancavelica, Peru” that has an effective date of 09 April 2022 (the “technical report”). (“Technical Report”).
3. I graduated with a Bachelor of Science in Civil Engineering from the University of Arizona in 2003 and a Master of Science in Civil Engineering from the University of Arizona in 2008.
4. I am a registered professional engineer in good standing in the State of Arizona in the area of Structural Engineering (No. 47714). I am also registered as a professional engineer in the states of California (No. 73405), Nevada (No. 029163) and Michigan (No. 6201057625).
5. I have worked as engineer for a total of 18 years. My experience includes 16 years at M3 Engineering and Technology Corporation working on all aspects of mine plant development for base and precious metals project with a specific focus on plant layout, infrastructure, estimating and scheduling. I have been involved with studies as well as full engineering, procurement and construction management (EPCM) projects.
6. I have read the definition of “Qualified Person” set out in National Instrument 43-101 (“NI 43-101”) and certify that by reason of my education, affiliation with a professional association (as defined in NI 43-101) and past relevant work experience, I fulfill the requirements to be a “Qualified Person” for the purposes of NI 43-101.
7. I am responsible for Sections 21.5 and 21.10.
8. I have not visited the project site.
9. I have not had prior involvement with the property that is the subject of the Technical Report.
10. As of the date of this certificate, to the best of my knowledge, information and belief, the Technical Report contains all scientific and technical information that is required to be disclosed to make the Technical Report not misleading.
11. I am independent of the issuer applying all of the tests in Section 1.5 of National Instrument 43-101.
12. I have read National Instrument 43-101 and Form 43-101F1, and the Technical Report has been prepared in compliance with that instrument and form.
13. As of the effective date of the technical report, to the best of my knowledge, information and belief, the sections of the technical report for which I am responsible contain all scientific and technical information that is required to be disclosed to make the technical report not misleading.



14. I consent to the filing of the Technical Report with any stock exchange and other regulatory authority and any publication by them, including electronic publication in the public company files on their websites accessible by the public, of the Technical Report.

Dated: June 13, 2022

“Signed”

---

John W. Woodson, P.E.

## CONTENTS

---

<b>1</b>	<b>SUMMARY.....</b>	<b>30</b>
1.1	Background .....	30
1.2	Previous Technical Reports .....	30
1.3	Qualifications of the consultants.....	31
1.4	Personal Inspection .....	31
1.5	Property description and location .....	32
1.6	Accessibility, Climate, Local Resources, Infrastructure and Physiography .....	33
1.7	History.....	33
1.8	Geology and Mineralization .....	34
1.9	Deposit Types .....	35
1.10	Exploration .....	35
1.10.1	Surface Sampling.....	35
1.10.2	Exploration Potential – Bethania Silver Mine .....	36
1.11	Drilling.....	37
1.12	Sample Preparation, Analyses and Security .....	37
1.13	Data Verification.....	38
1.14	Mineral Processing and Metallurgical Testing.....	39
1.14.1	Flotation Test – 2021 .....	39
1.15	Mineral Resources Estimates .....	39
1.16	Mineral Reserve Estimates.....	40
1.17	Mining Methods .....	41
1.18	Recovery Methods.....	46
1.19	Project Infrastructure.....	47
1.20	Environmental Studies, Permitting and Social Community Impact .....	48
1.21	Capital and Operating Cost.....	50
1.22	Economic Analysis .....	51
1.23	Adjacent Properties .....	53
1.24	Interpretation and Conclusions .....	53
1.24.1	Geology and Mineral Resources .....	53
1.24.2	Mining and Mine Plan .....	53
1.24.3	Metallurgy and Mineral Process Design .....	55
1.24.4	Tailings .....	55
1.24.5	Specific PEA Risks .....	55
1.25	Recommendations.....	56
1.25.1	Geology and Mineral Resources .....	56
1.25.2	Mining and Mine Plan .....	57
1.25.3	Metallurgy and Mineral Process Design .....	58

1.25.4	Project Infrastructure.....	58
<b>1.26</b>	<b>Tailings .....</b>	<b>58</b>
<b>2</b>	<b>INTRODUCTION .....</b>	<b>60</b>
2.1	Introduction .....	60
2.2	Terms of Reference.....	60
2.3	Qualified Persons.....	60
2.4	Site Visits and Scope of Personal Inspection .....	61
2.5	Effective Dates.....	61
2.6	Information Sources .....	62
<b>3</b>	<b>RELIANCE ON OTHER EXPERTS .....</b>	<b>63</b>
3.1	Introduction .....	63
3.2	Land Tenure.....	63
3.3	Surface Rights Agreements .....	63
3.4	Environmental .....	63
3.5	Depreciation, Taxes, and Royalties .....	64
3.6	Markets and Contracts.....	64
<b>4</b>	<b>PROPERTY, DESCRIPTION AND LOCATION .....</b>	<b>65</b>
4.1	Property Location .....	65
4.2	Land Tenure.....	65
4.2.1	Mining Concessions and Claims .....	66
4.2.2	Beneficiation Concession .....	69
4.3	Mining and Environmental Law and Regulations in Peru.....	69
4.3.1	Mineral Titles .....	70
4.3.2	Ownership of Mining Rights.....	70
4.3.3	Annual Fees and Obligations.....	71
4.3.4	Surface Rights.....	71
4.3.5	Small – Scale Production .....	72
4.3.6	Permitting and Regulatory .....	73
4.3.7	Ground Disturbance: Drilling and Trenching .....	73
4.4	Taxation and Foreign Exchange Controls .....	74
4.4.1	Credit for accumulated loss .....	74
4.4.2	Profit Sharing .....	74
4.4.3	Income Tax (IR).....	74
4.4.4	Taxes on Dividends .....	75
4.4.5	Temporary Tax on Net Assets (ITAN) .....	75
4.5	Royalties, Agreements and Encumbrances .....	75
4.5.1	Royalties.....	75
4.6	Environmental Liabilities.....	76
4.7	Other Significant Factors and Risks.....	77

<b>5</b>	<b>ACCESSIBILITY, CLIMATE, LOCAL RESOURCES, INFRASTRUCTURE AND PHYSIOGRAPHY</b>	<b>78</b>
5.1	Access to the Property .....	78
5.2	Climate and Operating Season .....	79
5.3	Local Resources and Infrastructure.....	79
5.3.1	Water Rights.....	80
5.3.2	Electricity.....	80
5.4	Physiography .....	81
<b>6</b>	<b>HISTORY .....</b>	<b>82</b>
6.1	Historical Mine Production.....	82
6.2	Historical Mineral Resource and Mineral Reserve Estimate .....	83
6.3	Historical Toll Processing Information .....	85
<b>7</b>	<b>GEOLOGICAL SETTING AND MINERALIZATION .....</b>	<b>87</b>
7.1	Regional Geology .....	87
7.2	Property and Local Geology .....	90
7.2.1	Lithology.....	94
7.2.2	Structure .....	94
7.2.3	Alteration .....	95
7.3	Mineralization .....	95
<b>8</b>	<b>DEPOSIT TYPES .....</b>	<b>96</b>
8.1	Intermediate Sulphidation Epithermal Deposits .....	96
<b>9</b>	<b>EXPLORATION.....</b>	<b>98</b>
9.1	High-Resolution Elevation Drone Survey (2019).....	98
9.2	Data Compilation and Review (2019) .....	98
9.2.1	2D Compilation – ArcGIS (2019).....	99
9.2.2	3D Compilation – Leapfrog (2019) .....	99
9.2.3	Geological Model (2019).....	100
9.3	Remote Sensing (2020) .....	100
9.4	Phase 1 Surface Exploration (2021) .....	101
9.4.1	Hilltop Zone Sampling .....	102
9.4.2	Main Zone (Bethania Mine Area) Sampling .....	102
9.5	Geological Modelling (2021).....	103
9.6	Phase 2 Surface Exploration (2021) .....	108
9.7	Exploration Potential – Bethania Silver Mine.....	110
9.7.1	Strike Length Extension.....	110
9.7.2	Depth Extension .....	110
9.7.3	New Surface Vein Discoveries.....	111
9.8	Exploration Potential – Other Concessions .....	111
9.8.1	Chinita I Concession .....	111

9.8.2	Carmelitas Concessions.....	111
9.8.3	Tres Banderas 01 through 07 Concessions and Claims.....	112
<b>10</b>	<b>DRILLING .....</b>	<b>113</b>
<b>10.1</b>	<b>Diamond Drilling Procedures.....</b>	<b>115</b>
10.1.1	Drill Hole Setup .....	117
10.1.2	Downhole Surveys and Core Orientation .....	117
<b>10.2</b>	<b>Drill Core Assay Results.....</b>	<b>118</b>
<b>11</b>	<b>SAMPLE PREPARATION, ANALYSES AND SECURITY .....</b>	<b>121</b>
<b>11.1</b>	<b>Certified Reference Material .....</b>	<b>121</b>
11.1.1	Blank Material .....	122
<b>11.2</b>	<b>Surface Vein Sampling (2021).....</b>	<b>123</b>
11.2.1	Sample Preparation and Analysis.....	123
11.2.2	Quality Assurance/Quality Control .....	123
<b>11.3</b>	<b>Diamond Drilling (2021) .....</b>	<b>124</b>
11.3.1	Core logging and Sampling.....	125
11.3.1.1	Core Collection.....	125
11.3.1.2	Core Logging.....	125
11.3.1.3	Sampling.....	126
11.3.2	Sample Storage and Security .....	127
11.3.3	Analytical - Sample Preparation and Analysis.....	128
11.3.4	Quality Assurance/Quality Control .....	128
11.3.5	Density Measurements .....	136
<b>12</b>	<b>DATA VERIFICATION .....</b>	<b>138</b>
<b>13</b>	<b>MINERAL PROCESSING AND METALLURGICAL TESTING .....</b>	<b>140</b>
<b>13.1</b>	<b>Samples.....</b>	<b>141</b>
<b>13.2</b>	<b>Mineragraphic Results .....</b>	<b>141</b>
<b>13.3</b>	<b>Comminution test.....</b>	<b>142</b>
<b>13.4</b>	<b>Grinding Tests.....</b>	<b>142</b>
<b>13.5</b>	<b>Flotation Results.....</b>	<b>143</b>
13.5.1	Flotation Test – 2001 .....	143
13.5.2	Flotation Test – 2011 .....	144
13.5.3	Flotation Test – 2012 .....	144
13.5.4	Flotation Test – 2013 .....	145
13.5.5	Flotation Test – 2014 .....	145
13.5.6	Flotation Test – 2015 .....	146
13.5.7	Flotation Test – 2021 .....	146
<b>13.6</b>	<b>Concentrate Quality Results.....</b>	<b>147</b>
<b>14</b>	<b>MINERAL RESOURCE ESTIMATES.....</b>	<b>148</b>

<b>14.1</b>	<b>Introduction .....</b>	<b>148</b>
<b>14.2</b>	<b>Resource Database .....</b>	<b>148</b>
14.2.1	Drilling Database .....	148
14.2.2	Collar Location and Downhole Deviation.....	149
14.2.3	Historical Data .....	149
14.2.4	Assay Sample Summary .....	149
<b>14.3</b>	<b>Estimation Methodology.....</b>	<b>150</b>
<b>14.4</b>	<b>Geological Interpretation and Modelling.....</b>	<b>151</b>
<b>14.5</b>	<b>Data Analysis and Estimation Domains.....</b>	<b>154</b>
14.5.1	Exploratory Data Analysis (EDA) .....	154
14.5.2	Estimation Domains .....	158
14.5.3	Contact Analysis, Compositing and Capping.....	159
<b>14.6</b>	<b>Specific Gravity .....</b>	<b>161</b>
<b>14.7</b>	<b>Block Modelling .....</b>	<b>162</b>
<b>14.8</b>	<b>Variography .....</b>	<b>163</b>
<b>14.9</b>	<b>Estimation Strategy.....</b>	<b>164</b>
14.9.1	Estimation Methodology.....	164
14.9.2	Estimation Parameters.....	164
<b>14.10</b>	<b>Block Model Validation .....</b>	<b>166</b>
14.10.1	Visual Validation.....	166
14.10.2	Comparison of Means .....	169
14.10.3	Statistical Validation of IDW Estimation Compared with Nearest Neighbour.....	170
<b>14.11</b>	<b>Mineral Resource Classification.....</b>	<b>172</b>
<b>14.12</b>	<b>Cut-off Grade.....</b>	<b>175</b>
<b>14.13</b>	<b>Mineral Resource Statement.....</b>	<b>176</b>
<b>15</b>	<b>MINERAL RESERVE ESTIMATES.....</b>	<b>180</b>
<b>16</b>	<b>MINING METHODS .....</b>	<b>181</b>
<b>16.1</b>	<b>Summary .....</b>	<b>181</b>
<b>16.2</b>	<b>Geotechnical Considerations.....</b>	<b>182</b>
16.2.1	Rock Mass Characterization – Q System.....	182
16.2.2	Rock Mass Characterization Using Rock Mass Rating.....	183
16.2.2.1	Stope Sizing .....	183
16.2.2.2	Defined Geotechnical Parameters .....	184
<b>16.3</b>	<b>Mining Method Selection .....</b>	<b>185</b>
16.3.1	UBC Mining Method Selection System – Qualitative Analysis.....	185
16.3.2	Trade Off Mining Method – Quantitative Analysis .....	188
<b>16.4</b>	<b>Mining Recovery and Dilution .....</b>	<b>188</b>
<b>16.5</b>	<b>Selection of Throughput Rate.....</b>	<b>189</b>
<b>16.6</b>	<b>Cut-off .....</b>	<b>190</b>
<b>16.7</b>	<b>Subset of the Mineral Resource Estimate Within the 2022 PEA Mine Plan .....</b>	<b>191</b>

<b>16.8</b>	<b>Design Assumptions and Design Criteria</b>	<b>191</b>
16.8.1	Selective Mining Unit	191
16.8.2	Production Levels	192
16.8.3	Access	192
<b>16.9</b>	<b>Backfill</b>	<b>194</b>
<b>16.10</b>	<b>Ventilation</b>	<b>194</b>
16.10.1	Introduction	194
16.10.2	Legislation	195
16.10.3	Air Requirement Calculation	195
16.10.4	Performed activities	195
16.10.5	Air Requirement Calculation	196
16.10.6	Proposed fans	198
16.10.7	Modeling results	198
<b>16.11</b>	<b>Pumping</b>	<b>201</b>
<b>16.12</b>	<b>Auxiliary services</b>	<b>201</b>
16.12.1	Water	201
16.12.2	Air	202
16.12.3	Energy	202
<b>16.13</b>	<b>Mine Infrastructure Facilities</b>	<b>202</b>
<b>16.14</b>	<b>Development and Production Schedule</b>	<b>203</b>
16.14.1	Development Schedule	203
16.14.2	Production Schedule	204
<b>16.15</b>	<b>Blasting and Explosives</b>	<b>205</b>
<b>16.16</b>	<b>Grade Control</b>	<b>206</b>
<b>16.17</b>	<b>Mining Equipment</b>	<b>206</b>
<b>17</b>	<b>RECOVERY METHODS</b>	<b>207</b>
<b>17.1</b>	<b>General Description</b>	<b>207</b>
<b>17.2</b>	<b>Process Design Criteria</b>	<b>209</b>
<b>17.3</b>	<b>Process Description</b>	<b>210</b>
17.3.1	Mineralized Material Reception	210
17.3.2	Crushing Operations	210
17.3.3	Grinding Operations – Classification	210
17.3.4	Bulk Flotation Circuit	211
17.3.5	Pb/Cu Separation Circuit	211
17.3.6	Zinc Flotation Circuit	212
17.3.7	Concentrates Dewatering	212
17.3.7.1	Lead Concentrate Dewatering	212
17.3.7.2	Zinc Concentrate Dewatering	213
17.3.7.3	Copper Concentrate Dewatering	213
17.3.8	Tailings thickening	213
17.3.9	Water supply	213

17.3.9.1	Fresh Water Supply .....	213
17.3.9.2	Process water .....	213
17.3.10	Air supply .....	214
17.3.11	Auxiliary systems.....	214
<b>18</b>	<b>PROJECT INFRASTRUCTURE.....</b>	<b>215</b>
<b>18.1</b>	<b>Area 1 - Existing &amp; Proposed Mine Infrastructure .....</b>	<b>217</b>
18.1.1	Roads & Drainage.....	218
18.1.2	Mine Accesses and Underground Development .....	219
18.1.3	Mine Waste dumps.....	219
18.1.4	Explosives Magazine and Accessories.....	219
18.1.5	Mine Power and Distribution.....	219
18.1.6	Compressors .....	220
18.1.7	Fuel Storage Tank and Distribution.....	220
18.1.8	Storage Areas, Workshops and Warehouses.....	220
18.1.9	Offices, Changing Rooms, and Canteen .....	220
18.1.10	Water Storage and Water Treatment.....	221
18.1.11	Contaminated Soils (oils, fuel) Storage Area.....	221
18.1.12	Conclusion - Mine Infrastructure .....	221
<b>18.2</b>	<b>Area 2 – Beneficiation Concession - Layout Design and Engineering.....</b>	<b>221</b>
18.2.1	Process Plant .....	222
18.2.2	Tailings Storage Facility - TSF .....	222
18.2.2.1	Tailings Management.....	222
18.2.2.2	Tailings Thickening, Transportation, Discharge .....	223
18.2.2.3	Surface Water Management.....	223
18.2.2.4	Monitoring and Instrumentation .....	224
<b>19</b>	<b>MARKET STUDIES AND CONTRACTS .....</b>	<b>225</b>
<b>19.1</b>	<b>Market studies.....</b>	<b>225</b>
19.1.1	Concentrates .....	225
19.1.2	Metal Price .....	227
19.1.3	Payable and Deductible .....	227
19.1.4	Metallurgical Recovery .....	228
19.1.5	Treatment Cost .....	228
19.1.6	Penalties.....	229
<b>20</b>	<b>ENVIRONMENTAL STUDIES, PERMITTING AND SOCIAL OR COMMUNITY IMPACT ...</b>	<b>231</b>
<b>20.1</b>	<b>Introduction .....</b>	<b>231</b>
<b>20.2</b>	<b>Historical Background .....</b>	<b>232</b>
<b>20.3</b>	<b>Environmental requirements and permits: overview of the legal framework ...</b>	<b>233</b>
<b>20.4</b>	<b>Environmental studies and permits .....</b>	<b>234</b>
20.4.1	Area 1.....	234



20.4.1.1	Environmental studies- Area 1.....	234
20.4.1.2	Permits relative to the mine and associated infrastructure - Area 1 .....	236
20.4.2	Area 2 .....	239
20.4.2.1	Environmental Studies- Area 2 .....	239
20.4.2.2	Permits related to the process plant, TSF and associated infrastructure- Area 2 241	
20.4.3	Environmental impacts .....	244
<b>20.5</b>	<b>Environmental liabilities .....</b>	<b>247</b>
<b>20.6</b>	<b>Mine closure.....</b>	<b>248</b>
20.6.1	Area 1 .....	248
20.6.2	Area 2 .....	249
20.6.2.1	Objectives of the closure plan.....	249
20.6.2.2	Closing components.....	250
20.6.2.3	Closing criteria.....	251
<b>20.7</b>	<b>Communities and social agreements .....</b>	<b>256</b>
20.7.1	Rural community of Poroche .....	257
20.7.2	Relationship protocols .....	258
20.7.2.1	Social policy protocol .....	258
20.7.2.2	Sustainable development protocol.....	258
20.7.2.3	Social responsibility protocol.....	259
20.7.2.4	Information and communications protocol.....	259
20.7.2.5	Citizen Participation Protocol .....	259
20.7.2.6	Interculturality .....	259
20.7.3	Agreements.....	259
<b>21</b>	<b>CAPITAL AND OPERATING COSTS .....</b>	<b>261</b>
<b>21.1</b>	<b>Introduction .....</b>	<b>261</b>
<b>21.2</b>	<b>Capital Cost Estimate Summary.....</b>	<b>261</b>
<b>21.3</b>	<b>Basis for the estimate – Capital Cost.....</b>	<b>261</b>
<b>21.4</b>	<b>Mine Capital Cost.....</b>	<b>262</b>
<b>21.5</b>	<b>Process Plant and Infrastructure Capital Cost. ....</b>	<b>262</b>
<b>21.6</b>	<b>Tailings Capital Cost .....</b>	<b>263</b>
<b>21.7</b>	<b>Owner’s Cost .....</b>	<b>264</b>
<b>21.8</b>	<b>Operating Cost Estimate Summary .....</b>	<b>264</b>
<b>21.9</b>	<b>Mining Operating Cost .....</b>	<b>265</b>
21.9.1	Mining Cost .....	265
21.9.2	Mine Supervision Costs .....	265
<b>21.10</b>	<b>Processing Operating Cost.....</b>	<b>266</b>
<b>21.11</b>	<b>Third party processing cost .....</b>	<b>266</b>

21.12	Tailings Operating Cost .....	266
21.13	Onsite G&A.....	267
21.14	Treatment & Refining Charges .....	267
<b>22</b>	<b>ECONOMIC ANALYSIS .....</b>	<b>268</b>
22.1	Cautionary Statements .....	268
22.2	Methodology Used .....	268
22.3	Principal Assumptions.....	269
22.3.1	Mineral Resource, Mine Plan, and Mine Life.....	269
22.3.2	Metallurgical Recoveries.....	269
22.3.3	Metal Prices .....	270
22.3.4	Discount Rate .....	270
22.3.5	Capital Costs.....	270
22.3.6	Sustaining Capital.....	271
22.3.7	Operating Costs.....	271
22.3.8	Closure Costs and Salvage Value.....	271
22.3.9	Financials.....	271
22.3.10	Inflation .....	271
22.3.11	Financials.....	271
22.3.12	Taxes and other government levies .....	272
22.3.13	Cash Flow Forecasts .....	272
22.4	Sensitivity analysis.....	279
<b>23</b>	<b>ADJACENT PROPERTIES.....</b>	<b>281</b>
23.1	Historical Veins and Mining Trials.....	282
23.2	Operating Mines .....	282
23.2.1	Corihuarmi Gold Mine.....	282
23.2.2	Heraldos Negros Mine .....	283
23.3	Other Exploration Targets .....	283
<b>24</b>	<b>OTHER RELEVANT DATA AND INFORMATION .....</b>	<b>284</b>
<b>25</b>	<b>INTERPRETATION AND CONCLUSIONS.....</b>	<b>285</b>
25.1	Geology and Mineral Resources .....	285
25.2	Mining and Mine Plan .....	286
25.3	Metallurgy and Mineral Process Design.....	287
25.4	Project Infrastructure.....	287
25.4.1	Tailings .....	288
25.5	Operating and Capital Cost Estimates.....	288
25.5.1	Operating Cost Estimates.....	288
25.5.2	Capital Cost Estimates.....	288
25.6	Financial Analysis.....	289
25.6.1	Specific PEA Risks .....	289

**26 RECOMMENDATIONS ..... 291**

- 26.1 Geology and Mineral Resources ..... 291**
- 26.2 Mining and Mine Plan ..... 292**
- 26.3 Metallurgy and Mineral Process Design..... 292**
- 26.4 Project Infrastructure..... 293**
- 26.5 Tailings ..... 293**

**27 REFERENCES ..... 294**

## FIGURES

---

Figure 1-1: After – Tax Economic Sensitivity to Silver Price, Operating and Capital Cost. Own elaboration.....	52
Figure 4-1: Province of Huancavelica, and District of Acobambilla, Peru, South America. Adapted from “NI 43-101 Technical Report & Mineral Resource Estimate” by Caracle Creek International Consulting Inc. February 21st, 2022. ....	65
Figure 4-2: Location of the Bethania Mine. Adapted from “NI 43-101 Technical Report & Mineral Resource Estimate” by Caracle Creek International Consulting Inc. February 21st, 2022. ....	68
Figure 5-1: Various access routes to travel to the Bethania Silver Project from Lima, Peru. Adapted from “NI 43-101 Technical Report & Mineral Resource Estimate” by Caracle Creek International Consulting Inc. February 21st, 2022. ....	78
Figure 5-2: Average annual temperatures and precipitation in Huancavelica Department, Peru (online source: meteoblue.com). Adapted from “NI 43-101 Technical Report & Mineral Resource Estimate” by Caracle Creek International Consulting Inc. February 21st, 2022.....	79
Figure 7-1: Regional geology of Peru showing the location of the Bethania Silver Project in the Cordillera Central, along with past and current producing mines. ....	88
Figure 7-2: Project-scale geological map with the general outline of the 12 properties that make up the Bethania Silver Project (source geology: INGEMMET Bulletins 44 and 73) .....	89
Figure 7-3: Property-scale geological and structural map of the Santa Elena concession (Bethania Mine); dacite (orange), andesite (yellow), siliceous body (green) (source: Milla, 2016a). ....	92
Figure 7-4: Satellite imagery suggests that the vein system in the Santa Elena mining concession (Bethania Mine) are almost central to what appears to be a wide zone of alteration sitting centrally within what appears to be an 11 km wide collapsed caldera, indicat indicating a much bigger exploration target both laterally and at depth. The red outline marks the general boundary of the Project concessions. ....	93
Figure 8-1: Generalized epithermal deposit models showing the various subtypes – low, intermediate and high sulphidation – in (a) volcanic setting and (b) rift setting (Sillitoe and Hedenquist, 2003). An approximation of the location of the volcanic associated Bethania Mine mineralization is circled in red.....	97
Figure 9-1: General geology and geochemistry map showing location and results of rock grab samples on the Santa Elena concession, Bethania Silver Project (source: Kuya news release dated 8 April 2021). ....	101
Figure 9-2: A 3D isometric view of the vein systems, looking towards the east, showing their spatial relation with the defining drilling and the underground workings .....	103

Figure 9-3: Plan view at the 4600 m level, showing the Española, 12 de Mayo, and Victoria principal vein systems (vein sets) with the faults blocks inside the Santa Elena concession 105

Figure 9-4: Section view, looking towards the east, showing the vein systems (vein sets) and the drilling intervals that define the mineralized structures.....107

Figure 9-5: Bethania property map showing the multitude of main silver- and gold-bearing veins mapped at surface and the planned trenching and surface sampling for the Phase 2 surface program (Kuya news release dated 15 November 2021). The Hilltop Zone is located .....109

Figure 9-6: Property maps: (left) location of the main Santa Elena concession within the area of recently acquired concessions and INGEMMET (2003) reported mineral occurrences and (right) close up of the Santa Elena concession and mineral occurrences reported by INGEMMET (2003) (Kuya Silver, 2021). .....109

Figure 10-1: Location of drill hole collars and traces from the Phase 1 drilling program, overlain on the general geology of the Santa Elena concession, Bethania Silver Project (source: Kuya Silver, 2021). .....114

Figure 10-2: Diamond drilling at platform number PLAT-017 and drill hole BDH-35 (source: Simon Mortimer, 2021). .....116

Figure 10-3: Example of cement marker/hole cover with drill hole information placed at each of the drill hole collar locations (source: Kuya Silver, 2021). .....116

Figure 10-4: Devico downhole DeviGyro™ multishot survey equipment (source: Simon Mortimer, 2021).....117

Figure 10-5: Orientated drill core measured using the Devico orientation tools, recorded by the drilling contractors, Ingeomin (source: Simon Mortimer, 2021). .....118

Figure 11-1: The on-site core cutting operation, completed by the geological service providers, BISA. (source: Simon Mortimer, 2021). .....127

Figure 11-2: The on-site secure sample storage facility with labelled nylon sacks containing the individual samples, ready and waiting shipment to the laboratory in Lima (source: Simon Mortimer, 2021).....128

Figure 11-3: QC/QC analyses for Au, Ag, Pb, Zn and Cu of the CRM PLSUL29 .....129

Figure 11-4: QA/QC analyses for Au, Ag, Pb, Zn and Cu of the CRM PLSUL30 .....130

Figure 11-5: QA/QC analyses for Au, Ag, Pb, Zn and Cu of the CRM PLSUL30 .....131

Figure 11-6: QA/QC analyses of the Course Blanks for Au, Ag, Pb, Zn y Cu .....132

Figure 11-7: QA/QC analyses of the Course Blanks for Au, Ag, Pb, Zn y Cu .....133

Figure 11-8: Duplicate Sample Analysis for Au .....134

Figure 11-9: Duplicate Sample Analysis for Ag .....134

Figure 11-10: Duplicate Sample Analysis for Pb .....135

Figure 11-11: Duplicate Sample Analysis for Zn .....	135
Figure 11-12: Duplicate Sample Analysis for Cu .....	136
Figure 11-13: Statistical analysis of the 59 density measurements, showing two separate populations with average readings of 2.71 and 3.1 for the two types of mineralized material, vein, and host rock.....	137
Figure 13-1: Flow Chart for Flotation Test.....	147
Figure 14-1: Summary of drill hole core sampled, Phase 1 drilling, Bethania Silver Project	150
Figure 14-2: Plan map of the Santa Elena concession showing the extent of the current resource model (yellow rectangle) .....	151
Figure 14-3: Isometric view of the Bethania vein model, showing the 3 principal vein systems .....	152
Figure 14-4: Example cross-section through the Bethania showing the alteration model...	153
Figure 14-5: Contact analysis plot using data from all modelled veins, showing silver assay statistics (oz/t) for samples inside and outside of the mineralised domains .....	159
Figure 14-6: Contact analysis plot using data from all modelled veins, showing lead assay statistics (%) for samples inside and outside of the mineralised domains.....	160
Figure 14-7: Contact analysis plot using data from all modelled veins, showing zinc assay statistics (%) for samples inside and outside of the mineralised domains.....	160
Figure 14-8: Histogram and statistical analysis of specific gravity samples .....	162
Figure 14-9: Long section of the Espanola Domain looking north .....	167
Figure 14-10: Long section of the 12 de Mayo Domain looking north.....	168
Figure 14-11: Long section of the Victoria Domain looking north .....	168
Figure 14-12: Swath Plot validations for the Espanola Domain showing Ag oz/t, Pb% and Zn% grades.....	171
Figure 14-13: Swath Plot validations for the Victoria Domain showing Ag oz/t, Pb% and Zn% grades.....	171
Figure 14-14: Swath Plot validations for the 12 de Mayo Domain showing Ag oz/t, Pb% and Zn% grades.....	172
Figure 14-15: Final classification of the Española Domain .....	173
Figure 14-16: Final classification of the Victoria Domain .....	174
Figure 14-17: Final classification of the 12 de Mayo Domain.....	174
Figure 14-18: Grade-Tonnage Curve for AgEq for the Bethania maiden Mineral Resource Estimate .....	175
Figure 14-19: Victoria Vein long-section showing historical workings, updated 2021 estimated block model grades (Indicated/Inferred only), and 2021 drill hole traces.....	178

Figure 14-20: 12 de Mayo Vein long-section showing historical workings, updated 2021 estimated block model grades (Indicated/Inferred only), and 2021 drill hole traces.....	179
Figure 14-21: Española Vein long-section showing historical workings, updated 2021 estimated block model grades (Indicated/Inferred only), and 2021 drill hole traces.....	179
Figure 16-1: Cut and Fill Conventional – Schematic. Own elaboration.....	187
Figure 16-2: Shrinkage – Schematic. Own elaboration. ....	187
Figure 16-3: 50X50m OCF panel. Own elaboration. ....	192
Figure 16-4: Mining Design – OCF, Isometric view. Own elaboration.....	193
Figure 16-5: Mining Access – OCF, plan view. Own elaboration. ....	193
Figure 16-6: Isometric View of mine in Ventsim. Own elaboration. ....	196
Figure 16-7: Main fan curve. Own elaboration.....	198
Figure 16-8: Isometric view of airflow - Ventsim. Own elaboration. ....	200
Figure 16-9: Schematic view of the pumping system. Own elaboration.....	201
Figure 16-10: Production Plan by Category. Own elaboration.....	205
Figure 16-11: Production Plan by Zone. Own elaboration. ....	205
Figure 17-1: Simplified Flow Sheet (BISA Ingeniería de Proyectos S.A January 2021) .....	208
Figure 18-1: Location map showing Area 1 - Santa Elena Mining Concession, and Area 2 – Plant Beneficiation. Adapted from “NI 43-101 Technical Report & Mineral Resource Estimate” by Caracle Creek International Consulting Inc. February 21st, 2022. ....	216
<i>Figure 18-2: Location and proposed location (DIA modification) of Area 1 infrastructure. Adapted from “NI 43-101 Technical Report &amp; Mineral Resource Estimate” by Caracle Creek International Consulting Inc.....</i>	<i>218</i>
Figure 18-3: Representative Section – Bethania Tailings Facility (UCSC 2021) .....	223
Figure 18-4: non-contact water from areas up- slope (UCSC 2021).....	224
Figure 20-1: Identification of Area 1 and Area 2. Adapted from “NI 43-101 Technical Report & Mineral Resource Estimate” by Caracle Creek International Consulting Inc. February 21st, 2022. ....	232
Figure 20-2: Existing environmental liabilities (Source: Kuya). Adapted from “NI 43-101 Technical Report & Mineral Resource Estimate” by Caracle Creek International Consulting Inc. February 21st, 2022. ....	248
Figure 22-1: Production and Cost Profile by Year. Own elaboration. ....	274
Figure 22-2: After-Tax Economic Sensitivity to Metal Price, Operating and Initial Capital Costs. Own elaboration. ....	280
Figure 22-3: Before-Tax Economic Sensitivity to Metal Price, Operating and Initial Capital Costs. Own elaboration.....	280

Figure 23-1: Limits of the projects (Source: Geocatmin) Adapted from “GEOCATMIN” by Instituto Geológico Minero y Metalúrgico (INGEMMET) .Retrieved June 14, 2013, from <https://geocatmin.ingemmet.gob.pe/geocatmin/>.....282



## TABLES

---

Table 1-1: Historical Mineral Resources, Bethania Mina, March 2016 (Milla, 2016a).....	33
Table 1-2: Historical Mineral Reserves, Bethania Mina, March 2016 (Milla, 2016a) .....	33
Table 1-3: Result of recoveries from flotation tests - 2021, Santa Elena mine .....	39
Table 1-4: Maiden Mineral Resources Estimate Statement for the Bethania Silver Project, Peru .....	40
Table 1-5: Projected Zone Recovery by Mining Method .....	42
Table 1-6: Projected Dilution by Mining width.....	42
Table 1-7: Conceptual Daily Production Scale Defined by Area/Zone .....	43
Table 1-8: Daily Production Scale defined by Zone .....	43
Table 1-9: Projected Mining Cost by Activity.....	44
Table 1-10: Subset of the Mineral Resource Estimate Within the 2021 PEA Mine Plan – Cutoff > 98.95 USD/t.....	45
Table 1-11: Mine Development per year.....	45
Table 1-12: Production Plan.....	46
Table 1-13: Distribution by Category.....	46
Table 1-14: Total Capital Cost Estimate .....	50
Table 1-15: Estimated LOM Operating Costs.....	51
Table 1-16: Economic Sensitivity to Silver Prices.....	52
Table 1-17: Recommended surface drilling program to test the Hilltop Zone vein system, Santa Elena concession.....	57
Table 4-1: Summary of mining concessions that comprise the Bethania Silver Project (Source: Geocatmin).....	66
Table 4-2: Summary of mining concessions that comprise the Bethania Silver Project (without superposition) .....	67
Table 4-3: Royalty Annex .....	76
Table 6-1: Summary showing the historical Bethania Mine mined tonnes and grades (1977-2016) .....	83
Table 6-2: Historical Mineral Resources, Bethania Mina, March 2016 (Milla, 2016a).....	83
Table 6-3: Historical Mineral Reserves, Bethania Mina, March 2016 (Milla, 2016a) .....	84
Table 6-4: Monthly production reported to the Ministry of Energy and Mines for the period 2013-2016 .....	85
Table 6-5: Summary of toll milling tonnes treated and recoveries (lead-zinc concentrates) 2013 to 2016, Bethania Mine. ....	86

Table 7-1: Known veins and their characteristics, Santa Elena mining concession .....	90
Table 7-2: Summary of the main lithologies underlying the 12 properties, Bethania Silver Project.....	94
Table 10-1: Summary of Phase 1 diamond drilling program completed in March to May 2021 .....	113
Table 10-2: Summary of drill core assay results, Phase 1 diamond drilling at Bethania Mine area (AgEq*).....	119
Table 10-3: Summary of dill core assay results, Phase 1 diamond drilling at the Hilltop Zone .....	120
Table 11-1: Summary of Certified Reference Material PLSUL29 used in the Kuya QA/QC program.....	121
Table 11-2: Summary of Certified Reference Material PLSUL30 used in the Kuya QA/QC program.....	121
Table 11-3: Summary of Certified Reference Material PLAUL31 used in the Kuya QA/QC program.....	122
Table 11-4: Summary of the number of primary and QA/QC samples taken and submitted to the laboratory as part of the 2021 surface vein sampling program.....	124
Table 11-5: Summary of the number of the primary and QA/QC samples taken and submitted to the laboratory as part of the Kuya 2021 Phase 1 diamond drilling campaign .....	124
Table 13-1: Summary of the production of the Santa Elena mine (2013 - 2016).....	140
Table 13-2: Summary of the Composite Head Assay Results .....	141
Table 13-3: Mineragraphic Results .....	142
Table 13-4: Bond Ball Mill Work Index Result .....	142
Table 13-5: Bond Abrasion Index Result.....	142
Table 13-6: Grinding Test Results 2014 and 2015 .....	143
Table 13-7: Grinding Test Results-2021.....	143
Table 13-8: Flotation Test Result – 2001, Santa Elena mine .....	144
Table 13-9: Flotation Test Result – 2011, Santa Elena mine .....	144
Table 13-10: Flotation Test Result – 2012, Santa Elena mine .....	144
Table 13-11: Flotation tests results - 2013, Santa Elena mine .....	145
Table 13-12: Result of recoveries from flotation tests - 2014, Santa Elena mine.....	145
Table 13-13: Result of recoveries from flotation tests - 2015, Santa Elena mine.....	146
Table 13-14: Result of recoveries from flotation tests - 2021, Santa Elena mine.....	146
Table 14-1: Summary of the basic statistics for all data points within the mineralised structures at Bethania.....	154

Table 14-2 : Summary statistics for the Victoria veins sets, grouped by individual mineralised structures (Domain) .....	155
Table 14-3: Summary statistics for the 12 de Mayo vein sets, grouped by individual mineralised structure (Domain).....	155
Table 14-4: Summary statistics for the Española vein sets, grouped by individual mineralised structure (Domain).....	156
Table 14-5: Summary statistics of assay data, grouped by structure and by sample type. Only the three principal structures have been considered .....	158
Table 14-6: Parameters of the definition of the block models.....	163
Table 14-7: Variogram parameters for silver, lead, and zinc.....	163
Table 14-8: Summary of search ellipse and estimation parameters. ....	164
Table 14-9: Comparison of the statistics between estimated results and input data .....	170
Table 14-10: Resource classification parameters applied to the mineral resource estimation .....	172
Table 14-11: Grade sensitivity analysis - tonnes and grade and contained metal for a range of AgEq cut-off values .....	175
Table 14-12: Maiden Mineral Resource Estimate Statement, Bethania Silver Project, Peru	177
Table 14-13: Mineral Resources by interpreted vein system .....	177
Table 14-14: Mineral Resources above/below the 4670 Level .....	178
Table 16-1: Selective Mining Unit Dimensions by Zone and Mining Method .....	183
Table 16-2: Rock Mass Rating Parameters .....	183
Table 16-3: Geomechanical Parameters for the UBC Methodology .....	184
Table 16-4: Maximum stable length along strike distance (Walls).....	185
Table 16-5: Geomechanical Parameters for the UBC Methodology .....	185
Table 16-6: UBC Comparative Table by Underground Mining Method .....	186
Table 16-7: Projected Zone Recovery by Mining Method .....	188
Table 16-8: Projected Dilution by Mining width.....	189
Table 16-9: Conceptual Daily Production Scale Defined by Area/Zone .....	189
Table 16-10: Daily Production Scale defined by Zone .....	190
Table 16-11: Cut Off by activity .....	190
Table 16-12: Projected Mining Cost by Activity.....	190
Table 16-13: Subset of the Mineral Resource Estimate Within the 2021 PEA Mine Plan – Cutoff > 98.95 USD/t.....	191
Table 16-14: SMU Dimensions by Proposed Mining Method .....	191

Table 16-15: Mining sections for preparation and development.....	192
Table 16-16: Annual Fill Requirements.....	194
Table 16-17: Calculation of Qtr.....	196
Table 16-18: Calculation of QMa .....	196
Table 16-19: Calculation of QMa .....	197
Table 16-20: Calculation of QTo .....	197
Table 16-21: Flow required by the KS mine.....	197
Table 16-22. Main ventilation system .....	198
Table 16-23: Air coverage of the ventilation system in Ventsim.....	199
Table 16-24: Industrial water requirement .....	202
Table 16-25: Air requirement .....	202
Table 16-26: Power requirement.....	202
Table 16-27: Mining Rate – Development and Preparations .....	203
Table 16-28: Mine Development per year.....	203
Table 16-29: Production Plan.....	204
Table 16-30: Mining Equipment – Mine Production .....	206
Table 17-1: Process Design Criteria .....	209
Table 19-1: Pb Concentrate Results.....	226
Table 19-2: Zn Concentrate Results.....	226
Table 19-3: Cu Concentrate Results.....	227
Table 19-4: Metal prices .....	227
Table 19-5: Payable and deductible for each metal .....	228
Table 19-6: Metallurgical recovery by element.....	228
Table 19-7: Costs of treatment, refining and sale .....	228
Table 19-8: Penalties by element and concentrate.....	229
Table 20-1: Environmental conditions, physical appearance.....	234
Table 20-2: Environmental conditions – biological aspect.....	235
Table 20-3: Existing environmental and social permits in Area 1 (Concessions Santa Elena) .....	236
Table 20-4: Environmental conditions, physical appearance.....	240
Table 20-5: Environmental conditions, biological aspects .....	241
Table 20-6: Existing environmental and social permits in the Area 2 (Benefit Concession – “Bethania Plant”).....	242

Table 20-7: Significance and nature of social and environmental impacts identified in previous IGAs .....	245
Table 20-8: Closure components approved in the EIA <sub>sd</sub> , 2019 .....	250
Table 20-9: Closure criteria proposed in the EIA <sub>sd</sub> , 2019 .....	252
Table 20-10: Areas of social influence in previous IGAs .....	256
Table 21-1: Total Capital Cost Estimate .....	261
Table 21-2: Plant Capital Cost Estimates .....	263
Table 21-3: Tailings Capital Cost Estimates .....	263
Table 21-4: Estimate Life of Mine Operating Cost .....	264
Table 21-5: Estimated Mine Operating Costs .....	265
Table 21-6: Estimated Mine Personnel Costs .....	265
Table 21-7: Tailings Operating Costs .....	267
Table 22-1: Metallurgical Recoveries .....	269
Table 22-2: Total Capital Cost .....	270
Table 22-3: Summary Cash Flow forecast (before taxes) .....	272
Table 22-4: The net present value (NPV), internal rate of return (IRR), and payback period .....	272
Table 22-5: Operating Cost Estimate per tonne .....	273
Table 22-6: Production and Cost Profile by Year .....	274
Table 22-7: Cash Flow Forecasts .....	275
Table 22-8: Economic Sensitivity to Silver Price .....	279
Table 22-9: Economic Sensitivity to discount rate .....	279
Table 23-1: Limits of the project .....	281
Table 25-1: Maiden Mineral Resource Estimate Statement, Bethania Silver Project, Peru ..	285
Table 26-1: Recommended surface drilling program to test the Hilltop Zone vein system, Santa Elena concession .....	291

## 1 SUMMARY

---

At the request of Canadian public company Kuya Silver Corporation (“Kuya”, or the “Company”, or the “Issuer”), Mining Plus. (“MP” or the “Consultant”), a private consulting company, has prepared this Preliminary Economic Assessment - National Instrument 43-101 (“NI 43-101”) Technical Report (the “Report”) on the Bethania Silver Project, located in central Peru, approximately 175 direct kilometres southeast of Lima.

### 1.1 Background

On 11 June 2020, private company Kuya announced that it had executed a definitive agreement with public company Miramont Resources Corp. (“Miramont”), whereby Miramont would acquire all of the issued and outstanding shares of Kuya pursuant to a three-cornered amalgamation (the “Transaction”) in which Kuya will amalgamate with 2757974 Ontario Inc., a wholly owned subsidiary of Miramont. Following the Transaction, the amalgamated company will be a wholly owned subsidiary of Miramont, and the new company will change its name to Kuya Silver Corporation.

On 1 October 2020, Kuya announced that it had completed its amalgamation transaction and received final approval from the Canadian Securities Exchange (“CSE”). The Common Shares of Kuya began trading on the CSE on 7 October 2020 under the symbol “KUYA”.

On 26 October 2020, Kuya announced that it had reached an agreement to acquire a 100% interest in S & L Andes Export SAC (“S&L”), the owner of the Bethania Silver mine property (Santa Elena mining concession). This agreement effectively replaced Kuya’s previous agreement to earn an 80% interest in S&L, Kuya entered into a letter agreement (the “Letter Agreement”) with S&L to acquire the additional 20% interest such that, on closing, Kuya would hold a 100% interest in the issued and outstanding securities of S&L.

On 16 December 2020, Kuya announced that through its indirect wholly owned Peruvian subsidiary (Kuya Peru S.A.C., formerly, Aerecura Materiales S.A.C.), it had acquired 100% of the issued and outstanding shares in the capital of S&L, and thereby owns 100% of the Bethania Silver Project. Kuya has since renamed S&L to Minera Toro de Plata S.A.C.

### 1.2 Previous Technical Reports

This Report is the Preliminary Economic Assessment (PEA) and replaces and supersedes the following:

- NI 43-101 Technical Report and Maiden Mineral Resource Estimate; Prepared by Caracle Creek; Effective Date 06 January 2022.
- Independent Technical Report on the Bethania Silver Project; Prepared by Caracle Creek; Effective Date 15 September 2021.

### 1.3 Qualifications of the consultants

The following Qualified Persons (QPs) as defined in National Instrument 43-101, Standards of Disclosure for Mineral Projects, and in compliance with Form 43-101F1 contributed to this report:

Mr. Edgard Vilela, (BA Mining Engineering, MAusIMM (CP)), Principal Mining Consultant, Mining Plus.

Scott Jobin-Bevans (Ph.D., PMP, P.Geo.), Principal Geoscientist, Caracle Creek International Consulting Inc.

Simon James Atticus Mortimer (M.Sc. ACSM, MAusIMM, MAIG, P.Geo.), Atticus Consulting S.A.C.

Donald Hickson, (BASC Civil Engineering, P.Eng.), Klohn Crippen Berger collaborator.

Laurie Tahija, (Bsc Mineral Processing Engineering, MMSA-QP), of M3 Engineering and Technology Corporation.

John Woodson, (MS Civil Engineering, P.E.), of M3 Engineering and Technology Corporation.

### 1.4 Personal Inspection

Mr. Edgard Vilela (MAusIMM (CP)), visited the Project site on the 25 of January 2022. While on site, he inspected proposed infrastructure locations, including topography of the area, existing portals, location of the proposed plant, location of the proposed tailings storage facility (TSF), location of existing waste dumps, roads and current accesses and the supply of water and energy.

Dr. Scott Jobin-Bevans (P.Geo., APGO #0813), visited the Bethania Silver Project for one day on 15 June 2019. The purpose of the personal inspection (site visit) was to observe mine and general Property conditions, superficial geology, underground geology, and mining procedures, proposed sites for the processing plant and related equipment, and sites for any exploration work including historical surface trenching and excavation (past mining), inclusive of associated quality assurance/quality control. During the site visit, a total of five rock samples were collected from five of the main veins, either from surface exposures or from underground workings, and analyzed.

Mr. Simon Mortimer (FAusIMM, FAIG), visited the Bethania Silver Project from the 24 to 27 May 2021 on behalf of Caracle Creek International Consulting Inc. Simon was accompanied by geologist Luis Huapaya, also from Atticus Consulting S.A.C., Lima, Peru. The purpose of the personal inspection was to observe the processes and protocols in place for the collection of geological data – the geological logging, the capture of data in digital format, the selection,

taking, and registering of samples, the associated quality assurance/quality control, and the transport and storage of the samples; to visit the drip pads and observe the procedures in place for the extraction of the core and delivery to the logging shed; and to review the drill core, the surface geology and map some of the principal structures, contacts and outcropping veins.

### 1.5 Property description and location

The Bethania Silver Project, located in the high Andes of Central Peru and about 70 km (direct) southwest of the city of Huancayo, capital city of neighbouring Junín Department, consists of 7 mining concessions and 5 mineral claims, situated near the borders of the departments of Huancavelica, Lima and Junín. Collectively, the 12 properties are referred to as the Bethania Silver Project (the “Project”) and the focus of the Report is on the Santa Elena mining concession (the “Property” or “Bethania”).

The Santa Elena concession, on which the Bethania Silver Mine (“Bethania Mine”) is located, is in the northwestern part of Huancavelica Department, Province of Huancavelica, and District of Acobambilla. The Property is about 316 km by road from Peru’s capital city of Lima, but it is possible to fly from Lima to Jauja (Jauja is about 50 km or a one-hour drive from Huancayo) and then drive southwest to the Property via Huancayo (about 4 hours).

Historically known as Mina Santa Elena, the Bethania Mine operated intermittently from 1977 and was put on care and maintenance in 2016. The Bethania Mine and related infrastructure are centred at approximate UTM coordinates 442766mE, 8603236mN (PSAD56, UTM Zone 18 South; EPSG:24878) and at about 4,688 meters above mean sea level (“mAMSL”).

The Santa Elena concession was originally registered in 1970 to cover artisanal and colonial-era pits and workings known at the time. This concession, covering 45 hectares (1.5 km x 300 m), is owned 100% by Kuya. All mineralization that is the focus of the Report, is located within the Santa Elena concession (11020736X01).

With respect to the other 11 properties, the Chinita I concession is registered to Kuya’s wholly owned Peruvian subsidiary S&L Andes Export S.A.C. (now Minera Toro de Plata S.A.C.), the Tres Banderas 01 to 07 are registered to Kuya’s wholly owned Peruvian subsidiary Aerecura Materiales S.A.C. (“Aerecura”) (now Kuya Silver S.A.C.), and Carmelita 2005, Carmelita 2005 I, and Carmelita 2005 II were purchased by Kuya Silver S.A.C. in May 2021.

The 12 properties that comprise the entire Project cover about 4,845 ha and annual concession right costs are about US\$14,535. The Company is permitted to undertake exploration work on all concessions and mineral claims.



## 1.6 Accessibility, Climate, Local Resources, Infrastructure and Physiography

The climate is seasonal with heavy rains (or snow) typically falling between November and March.

The cities of Huancayo and Huancavelica offer a range of goods and services, education institutions, and workers well-experienced in mineral exploration and mining.

The Bethania Mine uses generators to supply power, although there are transmission lines supplying energy to nearby active mines. There are several large lakes within the surrounding area, one of which is currently used as the water supply to the Bethania village.

The Project lies within a sub-circular altiplano surrounded by hilly topography between 4,691 and 4,858 m AMSL. Hillsides can be barren of vegetation, and the lower ground is populated by short grasses and scrub mostly used for transient sheep grazing.

## 1.7 History

S&L calculated its own internal mineral resources and mineral reserves estimates (Milla, 2016a; Milla and Osorio, 2016) for planning purposes, and at times to promote investment in the mining operation. Estimates made on six (6) veins by Milla (2016a) are summarized in Table 1-1 and Table 1-2.

*Table 1-1: Historical Mineral Resources, Bethania Mina, March 2016 (Milla, 2016a)*

Resources Category	Tonnes (t.)	Ag (oz/t)	Pb (%)	Zn (%)	Cu (%)	Ag
						(contained oz.)
Measured	67,710	15.94	4.39	2.5	0.25	1,190,033
Indicated	260,528	15.96	4.46	2.5	0.25	4,583,063
Inferred	132,964	14.94	4.94	2.94	0.3	2,195,573
<b>Total (Measured + Indicated)</b>						<b>5,773,096</b>
<b>Total (Inferred)</b>						<b>2,195,573</b>

*Table 1-2: Historical Mineral Reserves, Bethania Mina, March 2016 (Milla, 2016a)*

Reserves Category	Tonnes (t.)	Ag (oz/t)	Pb (%)	Zn (%)	Cu (%)	Ag (contained oz.)
Proven	67,710	15.94	4.39	2.50	0.25	1,190,033
Probable	41,444	15.28	4.73	2.96	0.27	698,243

These historical estimates were prepared by Dionicio Milla Simon - CIP 46162 - (Geological Engineer), as documented in a report titled, "Mina Santa Elena Estimación de Recursos y Reservas Minerales", dated March 2016, and were calculated using simple block modelling

for partially developed and measured stope blocks and larger indicated and inferred resource blocks extended in depth, using sampling data collected along the backs of the development levels.

Development on veins was methodically and consistently sampled and assayed for Ag, Pb and Zn, and the width of each vein sample and location is recorded. Copper was assayed only intermittently, and more sampling is required in order to include copper in any future mineral resource or mineral reserve estimates. No cut-off grade was provided, but a specific gravity (density) of 3.0 and a dilution factor of 5% were applied.

Mineral reserve estimates considered mineralized material that was immediately accessible above and below existing mine workings and was calculated exclusive of mineral resources.

The historical estimates are not considered current resources and are not consistent with NI 43-101 as they lack up-to-date sampling, sample preparation and assaying QA/QC support, and their estimation limits determined through robust geostatistical estimation. There are no recent estimates or data available to the Company with respect to these historical estimates.

Verification of the historical mineral resource and reserve estimates would require systematic diamond drilling in the area of the historical estimates in order to generate a statistically significant number of samples of the historical resource and reserve blocks. Future mineral resource and reserve estimates would also benefit from the re-sampling of the bottom level of the mine at the 4640 Level.

A qualified person has not done sufficient work to classify the historical estimates as current mineral resources or mineral reserves and Kuya is not treating the historical estimates as current mineral resources or mineral reserves.

Investors should not therefore rely on the historical estimates as current mineral resources or mineral reserves until they have been verified and supported in a technical report in accordance with NI 43-101. Furthermore, the conversion of mineral resources to mineral reserves requires a mine plan, and there is at present no workable mine plan with these historical resources.

## **1.8 Geology and Mineralization**

The Bethania Silver Project is located in the Cordillera Central, which contains prolific and prospective base and precious metals belts that are host to numerous styles of mineralization including epithermal Au-Ag, porphyry Cu-Au-Mo, and replacement/skarn Zn-Cu. Peru is the second largest silver producer in the world with approximately 50% of silver production associated with gold production and 50% associated with base metal/polymetallic mines.

The Bethania Mine and other deposits, occurrences and mines in the immediate area are interpreted to be located within an ancient volcanic caldera. Mineralization exploited to date

comprises a swarm of steeply dipping east-northeast striking anastomosing narrow veins with vein widths ranging from a few centimetres to several meters.

## 1.9 Deposit Types

Given the lithological, structural, mineralogical and alteration characteristics observed at the Project and specifically in the Bethania Mine vein system, mineralization identified to date can be classified as a polymetallic intermediate sulphidation epithermal (“ISE”), with significant accumulations of silver, lead, zinc, copper, and gold.

## 1.10 Exploration

Prior to 2019, there had been no systematic surface or underground exploration at Bethania. The historical Mina Santa Elena, now the Bethania Mine, was put on care and maintenance in 2016 and so prior to 2019, there had been no systematic surface or underground exploration by the Issuer on the Project or the Property (Santa Elena concession).

Kuya initiated data and information compilation in 2019, completing a high-resolution drone-based high resolution elevation survey in April 2019, announced the results of surface vein sampling in April 2021, and completed a 4,988.05 m diamond drilling program, with final assay results announced July 2021 (see Section 10). Over the course of 2021, Kuya also conducted surface sampling over parts of the Santa Elena mining concession, as described below.

### 1.10.1 Surface Sampling

Over the course of 2021, more than 500 surface samples, including rock grab samples and trench samples, were collected from veins exposed at surface or under shallow cover, as well as mineralized or unmineralized host rock. The Company focused surface sampling primarily on two zones over the past year: the Main Zone (also referred to as the Bethania Mine Area) and the Hilltop Zone. The work was undertaken in two phases: Phase 1 occurred in February and March of 2021, in preparation for the 2021 drilling program described below; Phase 2 surface sampling began in November 2021 and is ongoing as at the date of this AIF.

#### Hilltop Zone Sampling

The easternmost area sampled to date (in Phase 1) identified a new vein at surface, named the Santa Elena vein or Veta Santa Elena, located in the northeast region of the Property, approximately 500 m along strike from the eastern limit of the Española underground workings. Rock grab samples were collected at approximately 10 m intervals along surface exposure of the vein system. Seven consecutive rock gran samples distributed over a length of 60 m, averaged 698 g/t Ag (22.4 oz/t Ag), 2.79 g/t Au and 3.07% Pb. Results from the Veta Santa Elena sampling included:

- 2833 g/t Ag (91.1 oz/t Ag), 5.20 g/t Au, 10.6% Pb
- 300 g/t Ag (9.6 oz/t Ag), 11.03 g/t Au, 2.17% Pb
- 812 g/t Ag (26.1 oz/t Ag), 0.32 g/t Au, 4.82% Pb.

A second zone of interest was located at the intersection between a parallel vein structure to the Española 2 vein and the newly identified “Samantha” vein in the northeast part of the Property. At the vein intersection, four consecutive rock grab samples distributed over a length of 30 m (northwest-southeast) averaged 258 g/t Ag (8.3 oz/t Ag) and 2.84% Pb. Along the Samantha Vein, three consecutive rock grab samples distributed over a length of 20 m (west-northwest-east-southeast) averaged 171 g/t Ag (5.5 oz/t Ag) and 2.33% Pb (see the Company’s news release dated April 8, 2021).

Further sampling of the Hilltop Zone in Phase 2 work resulted in positive results from the Mercedes Vein, Española 2 Vein, and No. 24 Vein. (See the Company’s news releases dated 26 January 2022, and 16 March 2022.)

#### Main Zone (Bethania Mine Area) Sampling

Sampling occurring recently in Phase 2 in the Main Zone has resulted in the recognition of numerous new mineralized vein structures (branches and splays) associated with the previously identified vein systems, 12 de Mayo, Victoria, and Española. In addition, some samples were taken on known veins to get a better sense of the trends and orientation of the higher-grade zones within the Bethania vein system. (See the Company’s news releases dated 26 January 2022 and 16 March 2022.)

One of the most promising discoveries from this area is the newly identified Carmen Vein (and Carmen Vein branch) located on the southern flank of the Bethania property, dipping to the north and sub-parallel to the Victoria Vein. While some samples reported anomalous silver (up to 343 g/t) it was found to be consistently mineralized by anomalous gold grades (up to 6.26 g/t) along a 300-metre strike length.

#### **1.10.2 Exploration Potential – Bethania Silver Mine**

At the Bethania Mine (Santa Elena concession), much can be gained by drilling along the well-known northeast-trending and lesser explored northwest-trending mineralized structures to determine strike and depth continuity, from surface and/or from underground. In most cases, this should involve relatively low risk drilling to increase the known mineralized vein system along strike and at depth and provide a better understanding of the mineralization style on the Property.

Historically, production has focused on the vein systems at Bethania and to date, no systematic studies have been conducted to identify and characterize the disseminated

sulphide mineralization observed in the host rocks (*i.e.*, altered andesite-dacite and stockwork siliceous breccias) located between the vein sets.

### 1.11 Drilling

The 2021 diamond drilling program began on 16 March 2021 and achieved the drilling of 36 drill holes totalling 4,988.05 meters. Drill platforms were constructed according to the layout in the drilling permit using Kuya’s survey personnel who were responsible for marking the collar position (surveyed before and after drilling) and orientating the drill rig.

Drilling was contracted to Ingeomin S.A.C. (Lima, Peru) with all cores drilled in HQ3 (61.1 mm diameter). On completion of each drill hole the casing was removed, the hole opening cemented closed, and the location covered with a cement marker. The drilling contractor was responsible for recording the downhole survey, using a DeviGyro™ multishot surveying tool. The drilling contractor undertook surveys up and down the hole to verify the downhole surveys and the core was orientated using Devico core orientation tools.

For exploration objectives, the drilling program was split into two parts. Thirty-three drill holes (4,406.05 m) were drilled in the western third of the Property (Bethania Mine area), testing the seven main veins that make up historical mineral resources, and three drill holes (582 m) in the Hilltop Zone (east-north-eastern portion of the Property) where Kuya had previous identified mineralized veins at surface.

The drilling program identified the continuation of the main veins, mineralization style and grade in the area of the historical resource and the drilling on the Hilltop Zone is interpreted to have intersected the Mercedes Vein in hole BDH-36, and the Española 2 Vein and Daniela Vein at depth in hole BDH-01.

### 1.12 Sample Preparation, Analyses and Security

Sample preparation and analyses has been undertaken for surface and drill core samples, both of which were accompanied by an internal QA/QC program consisting of inserting Certified Reference Material (“CRM”), blanks (coarse and fine), and twin samples for core. Surface samples were taken on site by conventional methods and placed in sample bags at the sampling location. Core was logged, cut and sampled on site using appropriate procedures and supervision.

During the 2021 exploration program, 120 surface samples were taken which were QC supported by including 12 control samples and 3,257 core samples were taken which were QC supported by the inclusion of 482 control samples.

The samples were temporarily stored in a secure warehouse on site until there was a sufficient number of samples to send to SGS Laboratories in Lima for assay. All transport of samples was done via a bonded courier service.

Samples were assayed for Au by fire assay, 36 elements by ICP-AES Multi-acid digestion and over limits of Ag, Pb, Zn by Atomic Absorption, multi-acid digestion. SGS Laboratories in Lima has international certifications OHSAS 18001, ISO 14001 and ISO 9001 and is accredited by INACAL under the NTP-ISO / IEC 17025 and is independent of the Issuer.

At the end of the drilling program all core was removed from site and transported to Lima for storage in a secure warehouse. Sample pulp and sample reject material was returned by SGS and is also stored in the same warehouse.

Samples for density determination were undertaken at the end of the modelling process when all available information had been compiled. A total of 59 samples were selected within modelled veins and other mineralized structures in the footwall and hanging wall of the vein structures. Results showed an average specific gravity of 3.1 g/cm<sup>3</sup> for the vein material and 2.71 g/cm<sup>3</sup> for the mineralized structures in the and hanging wall.

### **1.13 Data Verification**

The Authors have reviewed the historical data and information regarding past exploration, development work, and historical mining on the Project as provided by Kuya. Kuya was entirely cooperative in supplying the Authors with all the information and data requested and there were no limitations or failures to conduct the verification.

Dr. Scott Jobin-Bevans (P.Geo., APGO#0813), visited the Bethania Silver Project for one day on 15 June 2019.

Mr. Simon Mortimer (MAusIMM, FAIG), visited the Bethania Silver Project from the 24 to 27 May 2021 on behalf of Caracle Creek International Consulting Inc.

Past mine production data and the safety statistics, as reported to the Peruvian Ministry of Energy and Mines (“MINEM”) during the period 2013-2016, is evidence that the mine was worked to accepted standards, and although it should be recognised that geological data relating this last period of mine working lacks QA/QC support (so there is an opportunity to improve in further work programs), mine mapping and sampling is noted to be of a high standard, and the authors are confident that this data can be used for guidance in the planning of future work programs and for the purposes of geological modelling and inclusion in mineral resource estimation.

For the mining section, the information provided by Kuya Silver has been reviewed, which includes the available underground topography (2D and 3D), current Environmental Impact

Statement (DIA), resource model and field visit to verify the location of the existing components and the possible infrastructure to be installed.

Edgard Vilela (MAusIMM (CP), #992615), visited the Bethania Silver Project for one day on 25 January 2022.

### 1.14 Mineral Processing and Metallurgical Testing

Between 2001 and 2021, metallurgical tests work programs were completed for the Bethania project mineralized material. Minera Toro de Plata (previously S&L Andes Export SAC Company) hired external laboratories to carry out the preliminary metallurgical tests of the samples from the Santa Elena mine.

The objective of the preliminary metallurgical program was to develop the flotation conditions for the recovery of lead, zinc, and other commercial metals and to identify possible issues in the treatment of the samples.

The test work programs were carried out in the following laboratories in Lima -Peru:

- ETUDES METALLURGIQUES ET D 'ENGINEERING EIRL (EMEDE) in 2001-2011-2012.
- ED&ED Ingeniería y Servicios SAC in 2013.
- Universidad Nacional de Ingeniería (UNI) in 2014-2015.
- Laboratorio Metalúrgico Chapi in 2021.

#### 1.14.1 Flotation Test – 2021

Four batch flotation tests were performed. The head grade of the sample was 7.88% Pb, 1,729 g/t Ag, 8.53% Zn and 0.82% Cu. The average results of the flotation tests are shown Table 1-3.

*Table 1-3:Result of recoveries from flotation tests - 2021, Santa Elena mine*

Product	Concentrate Grade						Global Recovery					
	Ag	Pb	Zn	Cu	Sb	As	Ag	Pb	Zn	Cu	Sb	As
	(g/t)	(%)	(%)	(%)	(%)	(%)	(%)	(%)	(%)	(%)	(%)	(%)
Rougher Bulk	9120	39.03	22.41	4.44	2.69	0.48	75.8	67	37.9	72.2	72.3	55.84
Scv Bulk	5680	34.3	22.41	2.36	1.57	0.3	12	15	9.6	9.8	10.7	8.87
Rougher Zn	1250	6.79	44.08	0.8	0.45	0.13	6.2	6.9	44.2	7.7	7.2	8.9
Scv Zn	1221	9.09	15.55	1	0.51	0.21	1.5	2.2	3.8	2.3	2	3.5

### 1.15 Mineral Resources Estimates

The Maiden Mineral Resource Estimate for the Project has been completed on the Bethania Project using all available information and data (Table 1-4). The Mineral Resources for the



Project were classified in accordance with the most current CIM Definition Standards (CIM, 2014).

Table 1-4: Maiden Mineral Resources Estimate Statement for the Bethania Silver Project, Peru

Category	Tonnage	GRADE						CONTAINED METAL	
		Ag	Pb	Zn	Au	Cu	AgEq	Ag	AgEq
		(g/t)	(%)	(%)	(g/t)	(%)	(g/t)	(oz)	(oz)
Indicated	404,000	332	2.63	1.95	0.26	0.16	451	4,317,540	5,858,521
Inferred	700,000	249	2.51	1.58	0.24	0.12	356	5,600,256	8,006,431

\*Silver equivalent (AgEq) is calculated using metal prices (in US\$) of US\$1,849.78 /oz gold, US\$25.44 /oz silver, US\$1,981.79 /t lead, US\$2,658.62 /t zinc, and US\$7,971 /t copper, and by applying recovery factors of 0.4439, 0.9324, 0.9449, 0.9265, and 0.8829, respectively.

In order to determine the quantity of mineralization that shows a “reasonable prospect for eventual economic extraction” using underground mining methods, QP Simon Mortimer, generated two block models, the first being a sub-blocked model based on the geometries of the mineralised structures and the second being a regularised block model with block size based on a minimum mining width of 0.6m. The material that shows a reasonable prospect for eventual economic extraction was determined using the regularized block model, applying a cut-off of 100 ppm silver equivalent, which was based upon the based an evaluation of current mining and processing costs. The final resource estimation statement also considered the material in the upper levels that had already been extracted and the material that could not be mined due to safety concerns.

It is the opinion of the QPs that the Maiden MRE (see Table 1-4), completed in accordance with the requirements of the NI 43-101, reasonably reflects the mineralization that is currently known on the Bethania Silver Project and that there are reasonable prospects for future economic extraction, likely using narrow vein underground mining methods.

The Mineral Resources are not mineral reserves and do not have demonstrated economic viability. The estimate is categorized as Inferred, Indicated and Measured resources based on data density, geological and grade continuity, search ellipse criteria, drill hole density and specific interpolation parameters. The Effective Date of the mineral resource estimates is 10 December 2021, based on the drill hole data compilation status and cut-off grade parameters.

### 1.16 Mineral Reserve Estimates

There are no current mineral reserves on the Property.



### 1.17 Mining Methods

For the definition of the mining method with which the exploitation of the Santa Elena mine will be carried out, a qualitative and quantitative analysis (trade off) was developed between several mining methods that could be applied. To develop both analyses, a process map was generated consisting of:

- Qualitative analysis
  - Evaluation using the UBC (University British Columbia analysis method) methodology.
  - Geomechanical evaluation.
  - Operational Evaluation (operational criteria of the selected method).
- Quantitative analysis (Gross margin: Income - costs).

#### **Qualitative analysis:**

The qualitative analysis was developed with the available geological information analysed using the UBC methodology (University British Columbia analysis method), where geometric information, type of deposit, geotechnical conditions of the mineral and geotechnical conditions of the stopes are entered. The results of the applicable mining methods are referential to the base parameters analysed. The Conventional Cut and Fill, Square Set and Shrinkage Stopping mining methods resulted in the best valuation for the deposit. The importance of the application of the UBC methodology is the identification of the alternatives with the best value for application in the specific deposit.

As a second analysis process, the geomechanical evaluation was developed, for which the modified stope stability graphic method (Potvin, 1988) was used to analyse the maximum dimensions of the stopes. In the case of the Santa Elena mine, the stopes are in the range of thicknesses from 1 to 3m and heights in a range of 2.1 to 3m, the maximum attainable length would be limited by the operation of the excavations. The operational part considers 2 sides per mining block and each side a length of 25 meters. It is worth mentioning that the available information does not allow determining or ruling out the possible presence of faulting parallel to the mineralized structure. Therefore, the use of wooden props within the area of exploitation is recommended, in order to control possible unstable blocks, primarily on the walls.

Under these considerations, the recommended exploitation methods for the rock mass conditions are Conventional Cut and Fill and Shrinkage Stopping.

From the qualitative analyses developed, it is concluded that the Conventional Cut and Fill and Shrinkage Stopping mining methods are the most suitable technical and operational alternatives for the exploitation of the Santa Elena mine.

**Quantitative analysis:**

In the qualitative analysis stage, Conventional Cut and Fill (OCF) and Shrinkage Stopping were identified as the best alternative mining methods for the exploitation of the deposit, with this input economic stopes were generated for both mining methods. The purpose of this process was to identify the option that presents the highest gross margin (Revenue - operating cost) for the project.

The Conventional Cut and Fill method is the one that obtains the best economic results compared to Shrinkage stopping, achieving the first 54% higher economic margin.

Mining Plus determined based on the qualitative and quantitative evaluation that the mining method applicable to the Santa Elena mine is the conventional Cut and Fill method.

**Mining Recovery and Dilution:**

A mining recovery of 95% was assumed for the Conventional Cut and Fill method and the operational dilution (% variable dilution) was applied, where a minimum width of 0.6 m is established, and the dilution value is variable depending on the width of the vein. The circado variant will allow the dilution to be controlled given its applicability in narrow veins and stability control in the stopes.

The total dilution is made up of internal dilution (dilution generated at the design width of the stopes) and operational dilution that is generated by the effects of the mining process. Table 1-5 and Table 1-6 show the mining recovery for the extraction method and the operational dilution parameters applied as a function of the design mining width.

*Table 1-5: Projected Zone Recovery by Mining Method*

Zone	Mining Method	Mining Recovery (%)
12 de Mayo	OCF	95
Española	OCF	
Victoria	OCF	

*Table 1-6: Projected Dilution by Mining width*

Layout Width			% Unplanned Dilution
0.60	to	1.00	16.4%
1.00	to	1.20	12.1%

Layout Width			% Unplanned Dilution
1.20	to	1.50	10.1%
1.50	to	2.00	8.0%
2.00	to	3.00	5.9%
3.00	to	4.00	4.2%
4.00	to	5.00	3.3%
5.00	to	5.10	3.3%

### Selection of Throughput Rate

Based on Taylor's rule analysis, the 350 t/d rate was considered to be a sustainable and adequate production rate for the proposed operation.

This gave a variable extraction rate for the different zones of the Santa Elena mine, as presented in Table 1-7 for a production rate of 350 t/d.

Table 1-7: Conceptual Daily Production Scale Defined by Area/Zone

Zone	Method of	NSR Cutoff ≥ \$98.95	Production Scale Range		
	Mined	Tonnes	Min	Max	Average *
			(t/d)	(t/d)	(t/d)
12 de Mayo	OCF	253,102	126	190	158
Española	OCF	368,169	167	251	209
Victoria	OCF	235,807	120	180	150
<b>Total</b>		<b>857,078</b>	<b>315</b>	<b>473</b>	<b>394</b>

(\*) Min/Max/Average are based on Taylor's rule and is not a typical average.

According to the Table 1-7, production rates were zone oriented which were then used in the consolidated mine plan as shown in Table 1-8.

Table 1-8: Daily Production Scale defined by Zone

Zone	Mining Method	Tonnes per Day (TPD)
12 de Mayo	OCF	100
Española	OCF	153
Victoria	OCF	97

### Cut Off

Mining Plus used information collected from similar projects in the region and from a benchmark from labour in small neighboring mine operations database to support the cut off determination summarized in Table 1-9.

*Table 1-9: Projected Mining Cost by Activity*

Activity	US\$/t
Exploitation Cost	46.19
G&A Mine	2.41
Preparation	5.54
<b>Mine OPEX</b>	<b>54.14</b>
Sustaining CAPEX	3.06
Plant OPEX	25.26
Total G&A	16.49
<b>Break Even Cut Off</b>	<b>98.95</b>

### Subset of the Mineral Resource Estimate Within the 2022 PEA Mine Plan

In Table 1-10 the economically Subset of the Mineral Resource Estimate is presented, which is above the cut off of 98.95 US\$/t. and considers recovery and dilution effects on stopes.

*Table 1-10: Subset of the Mineral Resource Estimate Within the 2021 PEA Mine Plan – Cutoff > 98.95 USD/t*

Category	Tonnes (t)	Ag (g/t)	Pb (%)	Zn(%)	Cu(%)	Au (g/t)	NSR (US\$/t)
Indicated	310,710	9.34	2.24	1.70	0.14	0.23	243
Inferred	546,368	7.57	2.37	1.46	0.11	0.19	203
<b>Total</b>	<b>857,078</b>	<b>8.21</b>	<b>2.32</b>	<b>1.54</b>	<b>0.12</b>	<b>0.20</b>	<b>218</b>

### Development and Production Schedule

#### Development Schedule

The beginning of the development and preparation plan was projected to start from month 7 of the pre-production year, for which rehabilitation works will be carried out at levels 670, 690, 700, 740 and the inclined shaft at level 630.

The development plan considers its start at level 670, 690 and the inclined shaft. The vertical and horizontal mine infrastructure will be developed in a conventional manner, due to the configuration of the mine (narrow veins). For ventilation and service chimneys, they will be carried out in a conventional manner with Jackleg and Stopper equipment.

*Table 1-11: Mine Development per year*

Type	Lat. / Vert.	Unit	Pre Production	1	2	3	4	5	6
Development	Lateral	m	858	2,005	1,776	1,352	2,012	1,232	881
	Vertical	m	-	30	17	31	-	60	-
Preparation	Lateral	m	287	1,604	1,077	583	994	915	804
	Vertical	m	1,009	1,851	1,060	1,595	1,995	2,061	1,338
<b>Total</b>		<b>m</b>	<b>2,154</b>	<b>5,491</b>	<b>3,930</b>	<b>3,561</b>	<b>5,000</b>	<b>4,268</b>	<b>3,024</b>

#### Production Schedule

The annual production rate will be 350 tpd, which will be reached in year 1. To support production, 21 active mining blocks are required.

The mine plan assumes that as of month 7 of the pre-production year, the development and preparation works will begin and for this the rehabilitation works will have already been carried out.

The extraction of mineralized material will be carried out through the pass/escape way using drag winches, then by means of mining cars and locomotives it will be extracted to the surface for work above level 670. For work below level 670 the use of the inclined shaft will transfer the mineralized material to the surface. The mineralized material on the surface will be taken with 15 m<sup>3</sup> dump trucks to the concentrator plant.

The proposed mine plan contains a total of 857,078 tonnes of mineralized material, 36% of the material comes from indicated resources, and 64% comes from the inferred resources. In Table 1-12 and Table 1-13 the annualized plan is presented with the mineralized material grades, average value and category.

*Table 1-12: Production Plan*

	Year								Total
	Preproduction	1	2	3	4	5	6	7	
<b>Tonnes of mineralized material (t)</b>	40,142	125,452	126,027	126,037	126,035	126,039	126,268	61,077	857,078
<b>NSR (US\$/t)</b>	306	238	207	215	241	212	181	183	218
<b>Oz/t Ag</b>	12.31	9.23	7.81	8.12	8.90	7.77	6.81	6.87	8.21
<b>gr/t Au</b>	0.15	0.16	0.19	0.21	0.25	0.24	0.17	0.22	0.20
<b>%Cu</b>	0.14	0.11	0.12	0.14	0.15	0.14	0.09	0.08	0.12
<b>%Pb</b>	2.11	2.57	2.17	2.15	2.96	2.37	1.92	2.07	2.32
<b>%Zn</b>	1.93	1.27	1.54	1.53	1.69	1.80	1.45	1.25	1.54
<b>TPD</b>	223	348	350	350	350	350	351	170	

*Table 1-13: Distribution by Category*

Category	Tonnes (t)	Ag (g/t)	Pb (%)	Zn (%)	Cu (%)	Au (g/t)	NSR (US\$/t)	% Distribution
Indicated	310,710	9.34	2.24	1.7	0.14	0.23	243	36%
Inferred	546,368	7.57	2.37	1.46	0.11	0.19	203	64%
<b>Total</b>	<b>857,078</b>	<b>8.21</b>	<b>2.32</b>	<b>1.54</b>	<b>0.12</b>	<b>0.2</b>	<b>218</b>	<b>100%</b>

## 1.18 Recovery Methods

The engineering design of the Minera Toro de Plata facilities was developed by the company BISA Ingeniería de Proyectos S.A. Based on the metallurgical testing and analysis described in Section 13 of this report, the plant design follows modern conventional practice. The Bethania concentrator plant will be designed to process 350 MTPD of mineralized material with average head grades of 0.3% Cu, 4.0% Pb and 3.0% Zn, to produce lead concentrate and zinc concentrate.

Flotation reagents are added to the grinding, lead, and zinc flotation circuits.

The plant will use conventional technology and the following process unit operations will be used to recover lead and zinc from the mineralized material:

1. Two-stage crushing.
2. A single grinding and classification stage.
3. One bulk flotation circuit.
4. One Lead / Copper separation flotation circuit.
5. One Zinc flotation circuit.
6. One Zinc regrinding circuit.
7. Thickening and filtration stages for lead and zinc concentrates.
8. One tailings thickener for water recovery.

### 1.19 Project Infrastructure

The infrastructure (existing and proposed) has been permitted using two separate environmental instruments; (1) an Environmental Impact Declaration (“DIA”) and modifications thereto which have been used to obtain the construction and operation license to permit the mining operation (existing underground mine and associated infrastructure); and, (2) a semi detailed Environmental Impact Assessment which has been used to permit a process plant, tailings storage facility (“TSF”) and associated infrastructure.

The existing mine area of the Project has a relatively small surface footprint, most of which is located within the western quadrant of the Santa Elena mining concession. The infrastructure comprises:

- Dirt roads of varying conditions connect mining levels, waste dumps and fixed infrastructure.
- Mine entrances for levels 760, 740, 720, 700, 690 and 670.
- Waste dumps on levels 760, 740 (2 separate dumps), 720 (2 separate dumps), 700 and 690.
- Explosive magazine and a separate area for storing of blasting accessories.
- Generator group (500 KWH capacity).
- Two areas for compressors sited to support ventilation and drilling.
- Fuel storage tank with fuel distribution system.
- Solid waste storage area, lubricant storage area, general workshop, and general warehouse.
- Offices, health and safety, mine planning, mine change house, lunchroom and superintendent office.
- Water neutralization pond to treat acid water drainage.

The above-mentioned infrastructure is what the mine required for historic mining, with the final product toll treated in various offsite process plants.

A modification to the existing environmental instrument (DIA) has been lodged with the relevant local authorities (DREM – Huancavelica) to approve the following changes to the infrastructure:

- New fuel station project: storage and distribution area.
- Water treatment plant for residual water.
- Contaminated soils (oils, fuel) storage area.

The general components of the process plant and TSF approved in the EIA<sub>sd</sub> consist of the following:

- Process plant.
- Tailings Storage Facility (TSF).
- Access road and connecting road network.
- Coarse mineralized rock stockpile.
- Overburden storage areas.
- Freshwater ponds (two), recirculation pond and contingency pond.
- Power plant, process plant sub-station, general substation.

No infrastructure exists in the area for the proposed process plant apart from 2.0 km of dirt roads that pass through the general area.

### **1.20 Environmental Studies, Permitting and Social Community Impact**

Permits have been granted to the various owners of the Project since the implementation of the first Peruvian environmental regulations, and these have been transferred to successive owners through corporate acquisition and/or property sale. The mine area was approved through a DIA and modifications (Santa Elena concession) and the process plant area, TSF and associated infrastructure was approved through an EIA<sub>sd</sub> (Bethania Plant Beneficiation Concession area, approved in an EIA<sub>sd</sub> that has been formally registered with the MEM, as required).

The DIA for the mine area was approved through Directorial Resolution No.102-2009-DIA – issued 3 November 2009. The DIA approved the exploration and exploitation of the mineral within the Santa Elena concession. The DIA has been modified a number of times with the last major modification taking place in 2017 which incorporated updating environmental impacts of the mining activities and how the company proposed to manage, prevent, mitigate, control, and monitor the mining operation. The DIA was also used as the basis for an approved ITS (Regional Directorial Resolution No. 005–2021/GOB–REG–HVCA/GRDE–DREM) for the construction of 20 drill platforms and associated works related to drilling activities undertaken in 2021 which are the subject of this report. In addition, the mine has an approved mine closure plan, Regional Directorial Resolution No. 107–2018/GOB–REG–HVCA/GRDE–



DREM, issued 5 December 2018. This resolution approved the Mine Closure Plan (temporal or definite closure) of the Santa Elena mine (Bethania Mine). Kuya is currently in the process of modifying the DIA presented in 2017 to include new components (water treatment plant to treat residual water and an area for treating contaminated hydrocarbon soils). The application was submitted on 14 December 2020 and is in process but is not required for construction.

The EIAsd for the process plant area was approved through Directorial Resolution No. 032-0200/GOB.REG.HVCA/GRDE/DREM – issued 21 August 2020. The components approved in the EIAsd comprised approval of the Beneficiation process plant, tailings facility and associated infrastructure.

Environmental liabilities identified in the DIA recorded liabilities on site which consisted of:

- Abandoned underground workings including stopes, mine level entrances, development drives, crosscuts and raises.
- Abandoned buildings and instillations including stockpiles (waste and mineral).
- Disturbed areas such as accesses to the historic mine workings.

The remediation of the areas identified have been included in the mine closure plan approved through Regional Directorial Resolution No. 107–2018/GOB–REG–HVCA/GRDE–DREM.

The Company submitted a closure plan for the Beneficiation Concession to the Dirección General de Asuntos Ambientales Mineros in November 2021.

The Company has developed and maintains good positive relationships with the Project's stakeholders, including land usage agreements with the local Poroche community of Bethania which include:

1. Usage of the land within the Santa Elena mining concession (45 ha). The Company has an agreement with the community to extend the land use for an additional ten-year term, with royalty payments set at US\$0.25+VAT per tonne mined, and the terms and conditions of this extension have been included in a binding agreement signed March 15<sup>th</sup> 2022.
2. Usage of the land within the Bethania Plant Beneficiation Concession area. The current agreement was signed on 21 August 2019 and increased the land usage area to 36.40 ha for an indefinite period. The contract includes fixed yearly payments and a royalty of US\$0.75 (excluding tax) for every tonne treated.

Other agreements include a verbal agreement for water usage and an agreement to rent a house in the local community.

### 1.21 Capital and Operating Cost

The capital cost estimate has been developed to provide an estimate suitable for the Technical Report (“PEA”), including costs to design, procure, construct, and commission the facilities.

The PEA estimates an initial CAPEX of US\$17.8M to start with a design production capacity of 350 tpd with a 25% contingency (applied to Mine, Plant, Tailings, others).

The PEA estimates a Total CAPEX of US\$24.5M with a 25% contingency (applied to Mine, Plant, Capital costs estimated have been summarized in Table 1-14.

*Table 1-14: Total Capital Cost Estimate*

Description	US\$	US\$	US\$
	Initial CAPEX	Sustaining CAPEX	Total CAPEX
Mine	\$2.4M	\$2.7M	\$5.2M
Process Plant	\$6.6M	\$0.0M	\$6.6M
Tailings and Waste Rock Disposal	\$3.2M	\$0.8M	\$4.0M
Surface Components	\$1.3M	\$0.0M	\$1.3M
Owner’s Costs	\$0.7M	\$0.0M	\$0.7M
Mine Closure	\$0.0M	\$1.9M	\$1.9M
<b>Total Capital Cost Pre - Contingency</b>	\$14.2M	\$5.4M	\$19.6M
Contingency Costs (25%)	\$3.6M	\$1.4M	\$4.9M
<b>Total Initial Capital Cost</b>	<b>\$17.8M</b>	<b>\$6.8M</b>	<b>\$24.5M</b>

Operating cost estimates have been developed to provide an estimate suitable for the Technical Report (“PEA”), including costs for mining and processing.

Operating cost estimates have been developed to provide an estimate suitable for a PEA, including costs for mining and processing. The expected accuracy range of the operating cost estimate is +25%/-30%. For treatment and refining costs market rates provided by the Company from a November 2021 market study were used.

LOM operating costs are summarized in Table 1-15.

Table 1-15: Estimated LOM Operating Costs

Operating Costs	LOM (US\$)	\$/tonne processed
Mining	\$31.4M	36.67
Processing	\$20.6M	25.72
Third party processing cost	\$1.4M	
Tailings	\$0.5M	0.59
Onsite G&A	\$14.1M	16.49
<b>Total Operating Costs</b>	<b>\$68.1M</b>	<b>79.46</b>
Treatment & Refining Charges	\$33.9M	39.54
Community Participation	\$0.9M	1.00
<b>Total Cash Costs</b>	<b>\$102.8M</b>	<b>120.01</b>
Sustaining Costs	\$3.4M	4.13
<b>All-in Sustaining Costs (AISC)</b>	<b>\$106.2M</b>	<b>124.14</b>

### 1.22 Economic Analysis

The financial analysis was carried out using a discounted cash flow (DCF) methodology. Net annual cash flows were estimated projecting yearly cash inflows (or revenues) and subtracting projected yearly cash outflows (such as capital and operating costs, royalties, and taxes). These annual cash flows were discounted back to the date of beginning of capital expenditure at mid-year 2022 and totaled to determine the NPV of the project at selected discount rates. Pre-production (year 0) also allows generation of income, once the existing development is rehabilitated and accessible, it will allow mining during the pre-production year and Kuya has the optionality to generate earlier revenues before processing facility completion by direct Mineralized Material trucking to third party processing facilities in the area. A discount rate of 5% was used as the base discounting rate. Sensitivity was run also at 8% and 10%.

In addition, the IRR, expressed as the discount rate that yields an NPV of zero, and the payback period, expressed as the estimated time from the start of production (end of year 0) until all initial capital expenditures have been recovered, were also estimated.

Sensitivities to variations in silver price, initial capital costs and operating costs were carried out to identify potential impacts on NPV and IRR are presented in Table 1-16.

Table 1-16: Economic Sensitivity to Silver Prices

		80% Price Ag Price Ag = 20.32 \$/oz	90% Price Ag Price Ag = 22.86 \$/oz	Price Ag Price Ag = 25.4 \$/oz	110% Price Ag Price Ag = 27.94 \$/oz	120% Price Ag Price Ag = 30.48\$/oz
Pre - Tax	NPV (5%)	\$51.9M	\$64.9M	\$77.8M	\$90.8M	\$103.7M
	IRR	130%	173%	227%	298%	392%
	Payback	0.68	0.53	0.41	0.32	0.24
After - Tax	NPV (5%)	\$37.7M	\$46.2M	\$54.7M	\$63.2M	\$71.7M
	IRR	116%	148%	188%	237%	304%
	Payback	0.7	0.6	0.5	0.4	0.3

Sensitivities to variations in silver price, initial capital costs and operating costs were carried out to identify potential impacts on NPV. The After-Tax Economic Sensitivity to silver price, Operating and Capital Costs is shown in Figure 1-1.

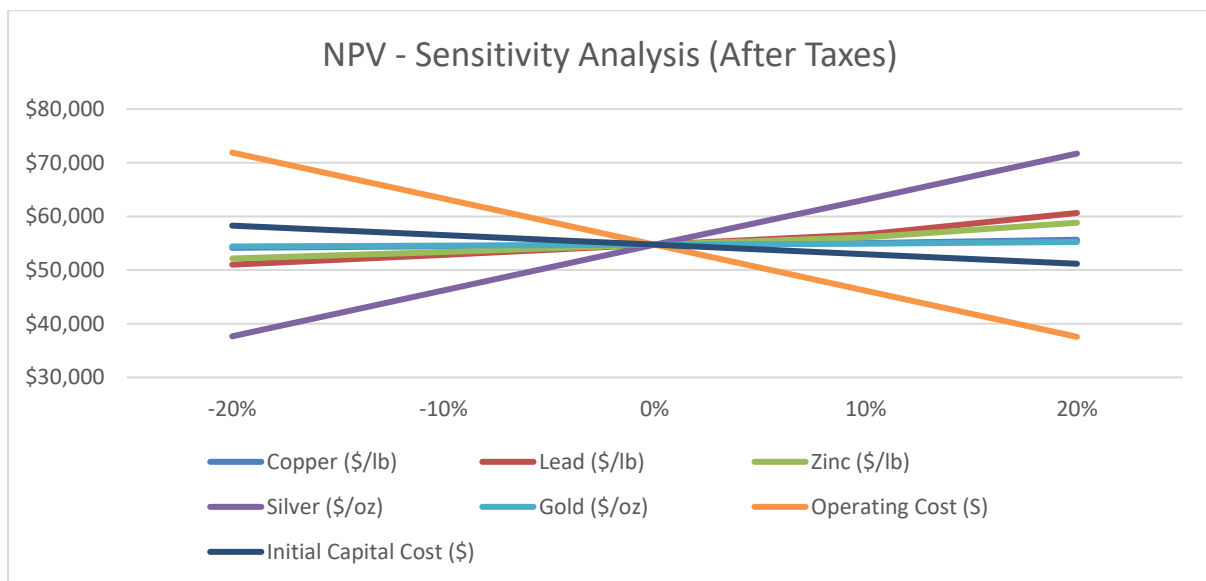

Figure 1-1: After – Tax Economic Sensitivity to Silver Price, Operating and Capital Cost. Own elaboration.

This PEA is preliminary in nature. The preliminary economic analysis is partly based on Inferred Mineral Resources that are considered too speculative geologically to have the economic considerations applied to them that would enable them to be categorized as Mineral Reserves, and there is no certainty that the PEA based on these Mineral Resources will be realized.

The proposed mine plan is based on a 36% indicated resources and 64% inferred resources. There is historically a higher risk of project failure if the PEA is used as basis for making a production decision.

### 1.23 Adjacent Properties

There are two producing mines, Corihuarmi gold mine, 9 km to the north-northwest, and Heraldos Negros Pb-Zn-Ag mine, 11 km to the East, and there is exploration activity currently proceeding throughout the surrounding area.

### 1.24 Interpretation and Conclusions

#### 1.24.1 *Geology and Mineral Resources*

- The historical Mina Santa Elena (now Bethania Mine) has been successfully worked on and off and on a very small scale from 1977 to 2016, but then ceased to work due to lack of investment in mine development and a much needed on site treatment facility.
- Past toll treatment of production has shown that the polymetallic minerals are suited to standard flotation processing although better recovery could be achieved for the zinc content.
- The 2021 drilling program from surface was mainly focused on the mine area and extensions to known veins for the purpose of adding support to develop the mine further in order to block out new mineral resources. This program has encountered low grade mineralization adjacent to and between the known veins which now needs to be considered as the Project moves towards underground exploration, a new mining method, and proposals for an on-site mineral processing facility.
- During the removal of timber supports there will be the opportunity to take new channel samples and test confidence in previous underground sampling and mapping, and the assaying of samples taken. This work should be fully supported by QA/QC and written geological procedures, together with detailed reporting.
- The vein system within the Property is considered to be open and prospective in all directions. Further surface exploration such as trenching, mapping, and sampling across the veins, adjacent to the veins and within intervening alteration, should be completed across the Property.
- The maiden Mineral Resource Estimate is encouraging and will form the basis for a Phase 2 diamond drilling program, with holes designed from surface and from underground set-ups, along with guiding additional future surface and underground exploration.

#### 1.24.2 *Mining and Mine Plan*

- Mr. Edgard Vilela, (BA Mining Engineering, MAusIMM (CP)) considers that conventional cut and fill (“OCF”) with waste fill is the optimal mining method for the mineralization reported at the Property.

- Mr. Edgard Vilela notes that mineralization reported at the Property is typical for narrow veins, and OCF successfully applied to numerous mines with mineralization with a similar geometry.
- Each mining block is made up of chimneys at the ends, a pass/escape way in the central part, a sub-level in the first cut of the block and a base drive that runs along the mineralized structure. The mining is ascending, and the filling will be carried out by means of excavations (filling with waste from the hanging wall).
- The mining plan contemplates the extraction of the mineralized material with the highest economic value in the first years, considering that the extraction panels are accessible (complete with development and preparation) through the mine entrances declared in the Environmental Impact Statement (DIA), then the plan develops towards the areas of lower value progressively.
- The extraction of mineralized material is projected to be carried out by the Nv 670 for the high zone (levels above the Nv. 670) and the inclined shaft will be used for the low zone (levels below the Nv. 670).
- Filling of stopes will be carried out with waste generated by the advances (at the beginning) and will be complemented with slashing typical of the mining method.
- The mine is in the process of rehabilitation, and as such it is projected to have accessibility to areas of with the best value mineralized material value from the pre-production stage (last 6 months of year 0) where average grades of 12.31 oz/t.
- The mining plan reaches a production of 350 tpd from year 1 and is maintained until year 6, reducing its production rates for year 7 considering the economic mineralized material.
- For the mining plan, indicated and inferred mineralized material has been considered, where 36% of the total mineralized material considered in the plan is indicated material and 64% is inferred material.
- Total tonnes to be mined was estimated to be 857,078 tonnes over the life of mine (including the Toll-Milling Option)
- Mining recovery of 95%, mine dilution varies between 3.3% and 16.4% depending on stope width.
- 70% of the stopes are between 0.6 - 1 meters of mining width, 10% of stopes are between 1.0 - 1.2 meters, 12% of are between 1.2 - 2 meters and 8% of stopes are between 2 - 5.1 meters.
- Average production over the mine life from the three vein systems: 12 de Mayo at 100 tpd, Española at 153 tpd, and Victoria at 97 tpd.
- Mine development over the mine life is planned to be 27,428 metres, including 2,154 metres prior to the plant start-up and 5,491 metres in the first full year.

### 1.24.3 Metallurgy and Mineral Process Design

- The test work is appropriate for a PEA study level.
- Flotation tests have been completed by an industrial laboratory at a level consistent with standard industry accepted practice.
- Based on the samples tested, the Santa Elena material can be ranked as medium hardness.
- The plant design follows modern conventional practice.
- The Bethania concentrator plant will have a capacity to process 350 MTPD of mineralized material with average head grades of 0.3% Cu, 4.0% Pb and 3.0% Zn, to produce lead concentrate and zinc concentrate.

### 1.24.4 Tailings

- The cost estimates were based on material take-offs and preliminary cost estimates as provided by a qualified earthworks contractor. As such, these are considered to be sufficiently accurate at PEA level. The quantity take-offs and the unit price build-ups were verified at PEA level only.
- It is noted that the proposed construction concept of excavation to create storage capacity, and especially in rock, is generally considered to be highly variable in terms of both cost and schedule. As such, given the balancing factors of the favorable level of costing detail, but also the uncertainty of the cost review and construction concept, the 25% contingency is considered to be acceptable.

### 1.24.5 Specific PEA Risks

- Risks and uncertainties which may reasonably affect reliability or confidence in future work on the Project relate mainly to the reproducibility of exploration results (*i.e.*, exploration risk) in a future production environment. Exploration risk is inherently high when exploring in epithermal polymetallic vein systems, however these risks are mitigated through the completion of surface geological and structural mapping, trenching, and sampling programs, high density (closely spaced drill holes) drilling programs, and when possible, by systematic sampling of underground mine workings that expose target vein systems.
- Aside from the recent change of government and related changes in policy, Peru's mining industry is highly regulated, and the permitting and reporting requirements for a mineral project can be complex, with several government agencies involved at different stages of development. As Kuya manages the permitting process for the Project, it may be required to delay and/or modify aspects or portions of the Project in order to meet all applicable requirements. These delays and/or changes to the Project could range in materiality from minor to significant.

- The PEA is not based on a feasibility study of mineral reserves, demonstrating economic and technical viability, and, as a result, there may be an increased uncertainty of achieving any particular level of recovery of minerals or the cost of such recovery, including increased risks associated with developing a commercially mineable deposit.
- Historically, such projects have a much higher risk of economic and technical failure. There is no guarantee that production will begin as anticipated or at all or that anticipated production costs will be achieved.
- Failure to commence production would have a material adverse impact on the Company's ability to generate revenue and cash flow to fund operations. Failure to achieve the anticipated production costs or revenue would have a material adverse impact on the Company's cash flow and future profitability.
- The Authors are not aware of any other significant factors and risks that may affect access, title, or the right or ability to perform the proposed work program on the Project or the Property.

## 1.25 Recommendations

### 1.25.1 *Geology and Mineral Resources*

- It is the Authors' opinion that additional exploration expenditures are warranted on the Bethania Silver Project and specifically the Property (Santa Elena concession). Future attention should also be given to the prospectivity of the additional concessions the Company has acquired or applied for in the region (*i.e.*, Chinita I, Carmelitas, and Tres Banderas 01 to 07).
- With respect to the Bethania Mine, an underground drilling program should also be implemented (*see details below*). An underground drone (UAV) survey is also recommended.
- Given the completion of the Phase 1 diamond drilling program and the maiden Mineral Resource Estimate on the Mine Zone vein system of the Santa Elena concession, further exploration work should focus on proving the down dip extension of the mine zone vein system, the definition of the vein system in the Hilltop Zone, and the development of a project scale three-dimensional geological interpretation. Surface work should be completed for trenching, sampling, mapping (geological, alteration and structural) of Hilltop Zone vein system, followed up with a drilling program to confirm downdip extension on the veins. Drill hole parameters for a recommended surface diamond drilling program are provided in Table 1-17.
- Surface geophysical surveys such as induced polarization (chargeability/resistivity) and a high-resolution magnetic survey (possible drone based) are also recommended.



Table 1-17: Recommended surface drilling program to test the Hilltop Zone vein system, Santa Elena concession.

DDH	North	East	Z	DD_Station	Target	Angle	Azimuth	Length (m)
P1	443223	8603039	4854	1	Veta Daniela, Española2, Rocio & Mercedes	-45	22	230
P2	443223	8603039	4854	1	Veta Daniela, Española2, Rocio & Mercedes	-55	22	270
P3	443175	8603052	4869	2	Veta Daniela, Española2, Rocio & Mercedes	-45	22	270
P4	443175	8303052	4869	2	Veta Daniela, Española2, Rocio & Mercedes	-55	22	325
P5	443130	8603082	4856	3	Veta Daniela, Española2, Rocio & Mercedes	-50	22	260
P6	443130	8603082	4856	3	Veta Daniela, Española2, Rocio & Mercedes	-60	22	320
P7	443235	8603201	4823	4	Veta Santa Elena & Mercedes	-45	15	80
<b>Total 670 Level</b>								<b>1,755</b>

- It is recommended that as soon as a permit is granted to proceed with underground access and exploration, that the Company considers an underground exploration program to (1) verify historical sampling information, and (2) to probe the down dip continuation of the mineralised structures.
- These locations will then have to be increased in size, sufficient to accommodate diamond-drilling equipment within the drill bays. Where ground conditions are very poor it may not be necessary to use drill and blast, and shotcrete may have to be used to support temporary advances until the final excavation shape has been completed.
- The cost of the recommended underground 20-hole diamond drilling program, together with geological support, and the mining of 10 underground drill bays is summarised in Table 1-17. It should be noted that this is only approximate, as it is not currently possible to go underground and carry out a more detailed examination of the ground and working conditions that will be encountered.

### 1.25.2 Mining and Mine Plan

- It is recommended to carry out a 3D topographical survey of the existing levels (if they are accessible), to identify the upper levels that can be used for the mine design in later stages.
- Kuya Silver has the option to generate earlier revenues with a third-party processing facility in close proximity to the mine to ensure that revenue can be generated in year zero. The assumption used in the PEA is that third-party processing will occur in year zero. This assumption is material to the overall economics of the project.
- The proposed mine plan is based on a 36% indicated resources and 64% inferred resources. In order to reduce risk, the percentage of inferred resources, especially early on in the mine plan, should be reduced.
- The mining plan considers that the rehabilitation will take place in the first 6 months of the pre-production year. Which is a key point to reach the production rate of 350 tpd.

**1.25.3 Metallurgy and Mineral Process Design**

- Develop a metallurgical testing program to confirm the process parameters and support the next phase of the Bethania project.
- Develop a closed-circuit metallurgical test program with regard to the mineralized structures of the deposit. The results of the tests will allow to estimate the metallurgical recovery for the life-of-mine (LOM) of the project.
- Perform rheological and sedimentation tests of tailings which will allow for confirmation of the preliminary design of the thickener and tails transport system.

**1.25.4 Project Infrastructure**

- In general, Kuya has obtained all the necessary operating permits (environmental certification, use of explosives, water use permit, among others), and also has the Environmental Impact Statement and its respective update, which address the identification of the environmental and social impacts caused by mining operations, providing environmental certification.
- In turn, the company has approved the Semi-detailed Environmental Impact Assessment (EIASd) for the processing plant, this environmental document includes the execution of participatory workshops through which the perceptions of the population were identified, and the social impacts were evaluated.
- Finally, it is important to specify that, to date, Kuya has an agreement with the Farming Community of Poroche for the use of surface land in which it assumes:
  - Maintain an adequate social environment that makes the development of the company's activities viable.
  - Do not disturb the use of surface areas, accesses and roads that are required for the development of mining activities, allowing their free and peaceful use for their benefit.
  - Allow and facilitate the company or whoever it designates the transit and access to the surface land, granting it all the necessary facilities and allowing the construction of additional access roads to said surface land, if applicable.
  - Provide unskilled labor for detailed maintenance of mining activities and the company.
- Provide additional space within the Community for the construction and operation of the company's sedimentation ponds.

**1.26 Tailings**

- Excavation quantities, and unit prices should be reviewed, to analyze possible variations if actual conditions vary from those anticipated. Initial reviews indicate that there could be significant variation from design.

- Given that Kuya is a listed company, it is recommended that the 2020 Global Industry Standard for Tailings Management be followed as closely as possible. Initially, this would include a detailed review by an Independent Technical Reviewer.

## 2 INTRODUCTION

---

### 2.1 Introduction

Kuya Silver Corp. (“Kuya” or the “Company”) requested that Mining Plus Peru S.A.C. (Mining Plus), compile a technical report (the Report) on an updated preliminary economic assessment study (2022 PEA) on the Bethania Silver Project (the “Project”), located in central Peru, about 175 direct kilometres southeast of Lima.

### 2.2 Terms of Reference

This Report supports the disclosure in Kuya’s news release dated May 4, 2022, entitled “Kuya Silver Announces Results of Independent Preliminary Economic Assessment”.

The term “Project” is used to refer to all of the mineral tenure holdings; the term “project” refers to the 2022 PEA study.

All measurement units used in this Report are metric unless otherwise noted. Currency is expressed in United States (US) dollars (US\$). The Peruvian currency is the Sol (S/). The Report uses Canadian English.

Mineral Resources are reported in accordance with the Canadian Institute of Mining, Metallurgy and Petroleum (CIM) Definition Standards for Mineral Resources and Mineral Reserves (May 2014; the 2014 CIM Definition Standards) and the CIM Estimation of Mineral Resources and Mineral Reserves Best Practice Guidelines (November 2019; 2019 CIM Best Practice Guidelines).

### 2.3 Qualified Persons

The following Qualified Persons (QPs) as defined in National Instrument 43-101, Standards of Disclosure for Mineral Projects, and in compliance with Form 43-101F1 contributed to this report:

Mr. Edgard Vilela, (BA Mining Engineering, MAusIMM (CP)), Principal Mining Consultant, Mining Plus.

Scott Jobin-Bevans (Ph.D., PMP, P.Geo.), Principal Geoscientist, Caracle Creek International Consulting Inc.

Simon James Atticus Mortimer (M.Sc. ACSM, MAusIMM, MAIG, P.Geo.), Atticus Consulting S.A.C.

Donald Hickson, (BASC Civil Engineering, P.Eng.), Klohn Crippen Berger collaborator.

Laurie Tahija, (Bsc Mineral Processing Engineering, MMSA-QP), of M3 Engineering and Technology Corporation.

John Woodson, (MS Civil Engineering, P.E.), of M3 Engineering and Technology Corporation.

The specific sections and sub sections each Qualified Person is responsible for is defined in their respective certificate.

## 2.4 Site Visits and Scope of Personal Inspection

Mr. Edgard Vilela (MAusIMM (CP)), visited the Project site on the 25 of January 2022. While on site, he inspected proposed infrastructure locations, including topography of the area, existing portals, location of the proposed plant, location of the proposed tailings storage facility (TSF), location of existing waste dumps, roads and current accesses and the supply of water and energy.

Dr. Scott Jobin-Bevans (P.Geo., APGO #0813), visited the Bethania Silver Project for one day on 15 June 2019. The purpose of the personal inspection (site visit) was to observe mine and general Property conditions, surficial geology, underground geology, and mining procedures, proposed sites for the processing plant and related equipment, and sites for any exploration work including historical surface trenching and excavation (past mining), inclusive of associated quality assurance/quality control. During the site visit, a total of five rock samples were collected from five of the main veins, either from surface exposures or from underground workings, and analyzed.

Mr. Simon Mortimer (FAusIMM, FAIG) visited the Bethania Silver Project from the 24 to 27 May 2021 on behalf of Caracle Creek International Consulting Inc. Simon was accompanied by geologist Luis Huapaya, also from Atticus Consulting S.A.C., Lima, Peru. The purpose of the personal inspection was to observe the processes and protocols in place for the collection of geological data – the geological logging, the capture of data in digital format, the selection, taking, and registering of samples, the associated quality assurance/quality control, and the transport and storage of the samples; to visit the drip pads and observe the procedures in place for the extraction of the core and delivery to the logging shed; and to review the drill core, the surface geology and map some of the principal structures, contacts and outcropping veins.

## 2.5 Effective Dates

The Report has several effective dates as follows:

The effective date of the Mineral Resource Estimate is December 10, 2021.

The effective date of 2021 PEA financial analysis: 09 April 06, 2022.

The overall effective date of this Report is the effective date of the financial analysis which is April 09, 2022.

## 2.6 Information Sources

This Report is based in part on internal Company technical reports, production reports, previous studies, maps, published government reports, company letters and memoranda, and public information as cited throughout this Report and listed in Section 27, References.

### 3 RELIANCE ON OTHER EXPERTS

---

#### 3.1 Introduction

The QPs relied upon the following other expert reports, which provided information regarding mineral rights, surface rights, royalties, property agreements, environmental liabilities, market conditions and contracts for this Report as noted below.

#### 3.2 Land Tenure

The QPs have not reviewed the land tenure, nor independently verified the legal status, ownership of the Project area or underlying property agreements.

Kuya has provided information with respect to Land Tenure used in Section 4 of this Technical Report. The QPs have fully relied upon and disclaim responsibility for information provided by Kuya with respect to Land Tenure.

#### 3.3 Surface Rights Agreements

All details related to surface rights agreements have been provided by Kuya.

Kuya has provided information with respect to surface rights agreements used in Section 4 and Section 20 of this Technical Report. The QPs have fully relied upon and disclaim responsibility for information provided by Kuya with respect to surface rights agreements.

#### 3.4 Environmental

The QPs have not independently verified the legal status of the historical environmental liabilities within the Project area. The QPs have fully relied upon, and disclaim responsibility for, information derived from experts retained by Kuya through the following document:

- The current DIA documents are:
  - Declaratoria de Impacto Ambiental, PERU, Modificación de la declaración de impacto ambiental – Categoría I para Pequeño Productor Minero Concesión Minera Santa Elena; Prepared by E. Soria; Effective Date 02 August 2020.
  - Declaratoria de Impacto Ambiental, PERU, Actualización Declaratoria de impacto ambiental Concesión Minera Santa Elena; Prepared by O. Tinoco; Effective Date 02 November 2016.

This information is used in Section 20 of the Report.

### 3.5 Depreciation, Taxes, and Royalties

The QPs have not independently verified the depreciation, taxes, and royalties applied in the financial model. The QPs have fully relied upon, and disclaim responsibility for, information derived from experts retained by Kuya in the following document:

The following document provided by Kuya Silver, has been used as a basis for the tax estimate and to evaluate the project after tax:

- Modelo Económico – Cálculo de Impuestos, PERU, Informe Nro 001 - 2022; prepared by José Manuel Baca Quiñonez; effective date 09 April 2022.

This information is used in Section 22 of the Report.

### 3.6 Markets and Contracts

Edgard Vilela (QP) has not independently verified marketing information on concentrates, or smelter terms information.

Concentrate market terms and conditions are a specialized business requiring knowledge of supply and demand of smelter capacity and concentrate types, as well as the terms and conditions of refineries/smelters for different quality of concentrate. This requires direct communication with refineries/smelters and an extensive database that is outside of the purview of a QP.

Jim Vice is the President at StoneHouse Consulting Inc and author of the report. From June 2008 to January 2018 Jim was responsible for the worldwide marketing of Zinc, Lead, and Precious Metals Concentrate for Teck Minerals Limited.

Since January 2017 Jim has worked with a number of mining companies to help them develop marketing strategies for base metal mining projects and is also consulting with a smelting company in the areas of metals sales and concentrate purchasing.

The QPs consider it reasonable to use Stonehouse Consulting Inc. for the marketing information on concentrates contained within the following document.

- Market, PERU, Bethania Concentrate Marketing Report; Prepared by Stonehouse Consulting Inc; Effective Date 19 November 2021.

This information is used in Section 19 of the Report. It is also used in support of the economic analysis in Section 22.



## 4 PROPERTY, DESCRIPTION AND LOCATION

### 4.1 Property Location

The Bethania Silver Project, located in the high Andes of Central Peru and about 70 km (direct) southwest of the city of Huancayo, capital city of neighbouring Junín Department, consists of 12 mining concessions situated near the borders of the departments of Huancavelica, Lima and Junín (Figure 4-1 and Figure 4-2; Table 4-1).

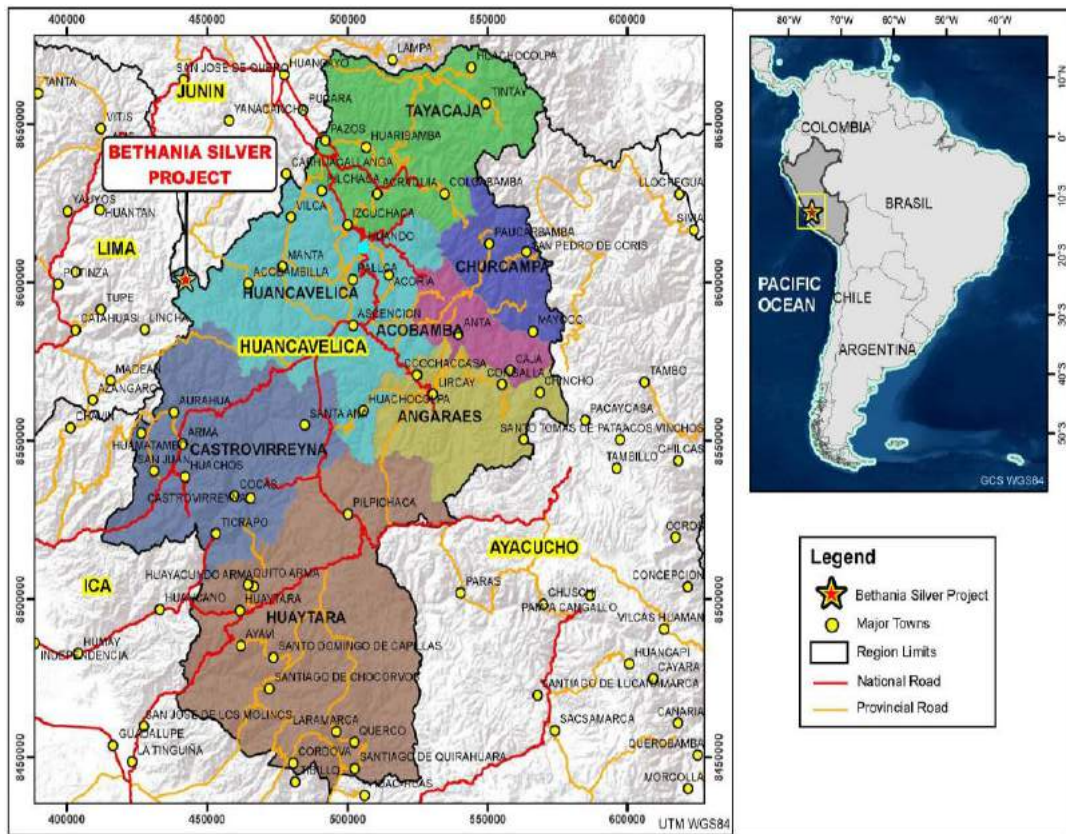

Figure 4-1: Province of Huancavelica, and District of Acobambilla, Peru, South America. Adapted from “NI 43-101 Technical Report & Mineral Resource Estimate” by Caracle Creek International Consulting Inc. February 21st, 2022.

### 4.2 Land Tenure

The Project comprises 12 mining concessions which are collectively referred to as the Bethania Silver Project (the “Project”). The focus of the Report is the Santa Elena mining concession (the “Property”) where the Company is focusing their current work. All concessions are located on topographic map sheet “Tupe 26-L” except Tres Banderas 01, 02, 03 and 04 which are in part located on map sheet “Conaica 26M” to the east.

#### 4.2.1 Mining Concessions and Claims

The entire Project (12 concessions) covers approximately 5,081 hectares (Table 4-1). Copies of the mineral titles for the 12 mining concessions, as supplied by Kuya, have been reviewed by the Authors. The Issuer owns or has the rights to 100% of the concessions listed in Table 4 1. All mineralization that is the focus of the Report, is located within the Santa Elena mining concession (11020736X01).

Table 4-1: Summary of mining concessions that comprise the Bethania Silver Project (Source: Geocatmin)

Name	Ownership	Type	Authorized	Reference	Hectares	Department	Province	District
Santa Elena	MINERA TORO DE PLATA SAC	Titulado (Concesion)	10-Jun-70	11020736X01	45.00	Huancavelica	Huancavelica	Acobambilla
Chinita I	MINERA TORO DE PLATA SAC	Titulado (Concesion)	11-Mar-10	650006710	200.00	Lima	Yauyos	Tupe
Tres Banderas 01	KUYA SILVER SAC	Titulado (Concesion)	5-Jul-19	010226519	500.00	Huancavelica	Huancavelica	Acobambilla
Tres Banderas 02	KUYA SILVER SAC	Titulado (Concesion)	12-Nov-18	010427218	1,000.00	Huancavelica Junín	Huancavelica Huancayo	Acobambilla Chongos Alto
Tres Banderas 03	KUYA SILVER SAC	Tramite	2-Nov-20	010188820	900.00	Huancavelica	Huancavelica	Acobambilla
Tres Banderas 04	KUYA SILVER SAC	Tramite	2-Nov-20	010188920	300.00	Huancavelica Junín	Huancavelica Huancayo	Acobambilla Chongos Alto
Tres Banderas 05	KUYA SILVER SAC	Tramite	2-Nov-20	010188720	700	Huancavelica Junín	Huancavelica Huancayo	Acobambilla Chongos Alto
Tres Banderas 06	KUYA SILVER SAC	Tramite	2-Nov-20	010188620	400.00	Huancavelica Lima	Huancavelica Yauyos	Acobambilla Tupe
Tres Banderas 07	KUYA SILVER SAC	Tramite	2-Nov-20	010188520	200.00	Huancavelica Junín Lima	Huancavelica Huancayo Yauyos	Acobambilla Chongos Alto Tupe
Carmelita 2005	S.M.R.L. Carmelita 2005	Titulado (Concesion)	9-May-05	010111005	400.00	Huancavelica Junín Lima	Huancavelica Huancayo Yauyos	Acobambilla Chongos Alto Tupe
Carmelita 2005 - I	S.M.R.L. Carmelita 2005 I	Titulado (Concesion)	24-Jun-05	010199105	200.00	Huancavelica Junín	Huancavelica Huancayo	Acobambilla Chongos Alto
Carmelita 2005 - II	S.M.R.L. Carmelita 2005 II	Titulado (Concesion)	21-Jul-05	010230705	200.00	Huancavelica	Huancavelica	Acobambilla
Planta Bethania	MINERA TORO DE PLATA SAC		22-Dic-21		36.39	Huancavelica	Huancavelica	Acobambilla
<b>Total</b>					<b>5081.39</b>			

Table 4-2: Summary of mining concessions that comprise the Bethania Silver Project (without superposition)

Name	Ownership	Type	Authorized	Reference	Hectares	Department	Province	District
Santa Elena	MINERA TORO DE PLATA SAC	Titulado (Concesion)	10-Jun-70	11020736X01	45.00	Huancavelica	Huancavelica	Acobambilla
Chinita I	MINERA TORO DE PLATA SAC	Titulado (Concesion)	11-Mar-10	650006710	200.00	Lima	Yauyos	Tupe
Tres Banderas 01	KUYA SILVER SAC	Titulado (Concesion)	5-Jul-19	010226519	500.00	Huancavelica	Huancavelica	Acobambilla
Tres Banderas 02	KUYA SILVER SAC	Titulado (Concesion)	12-Nov-18	010427218	1,000.00	Huancavelica Junín	Huancavelica Huancayo	Acobambilla Chongos Alto
Tres Banderas 03	KUYA SILVER SAC	Tramite	2-Nov-20	010188820	900.00	Huancavelica	Huancavelica	Acobambilla
Tres Banderas 04	KUYA SILVER SAC	Tramite	2-Nov-20	010188920	100.00	Huancavelica Junín	Huancavelica Huancayo	Acobambilla Chongos Alto
Tres Banderas 05	KUYA SILVER SAC	Tramite	2-Nov-20	010188720	700.00	Huancavelica Junín	Huancavelica Huancayo	Acobambilla Chongos Alto
Tres Banderas 06	KUYA SILVER SAC	Tramite	2-Nov-20	010188620	354.48	Huancavelica Lima	Huancavelica Yauyos	Acobambilla Tupe
Tres Banderas 07	KUYA SILVER SAC	Tramite	2-Nov-20	010188520	200.00	Huancavelica Junín Lima	Huancavelica Huancayo Yauyos	Acobambilla Chongos Alto Tupe
Carmelita 2005	S.M.R.L. Carmelita 2005	Titulado (Concesion)	9-May-05	010111005	370.82	Huancavelica Junín Lima	Huancavelica Huancayo Yauyos	Acobambilla Chongos Alto Tupe
Carmelita 2005 - I	S.M.R.L. Carmelita 2005 I	Titulado (Concesion)	24-Jun-05	010199105	200.00	Huancavelica Junín	Huancavelica Huancayo	Acobambilla Chongos Alto
Carmelita 2005 - II	S.M.R.L. Carmelita 2005 II	Titulado (Concesion)	21-Jul-05	010230705	200.00	Huancavelica	Huancavelica	Acobambilla
Planta Bethania	MINERA TORO DE PLATA SAC		22-Dic-21		36.39	Huancavelica	Huancavelica	Acobambilla
<b>Total</b>					<b>4806.69</b>			



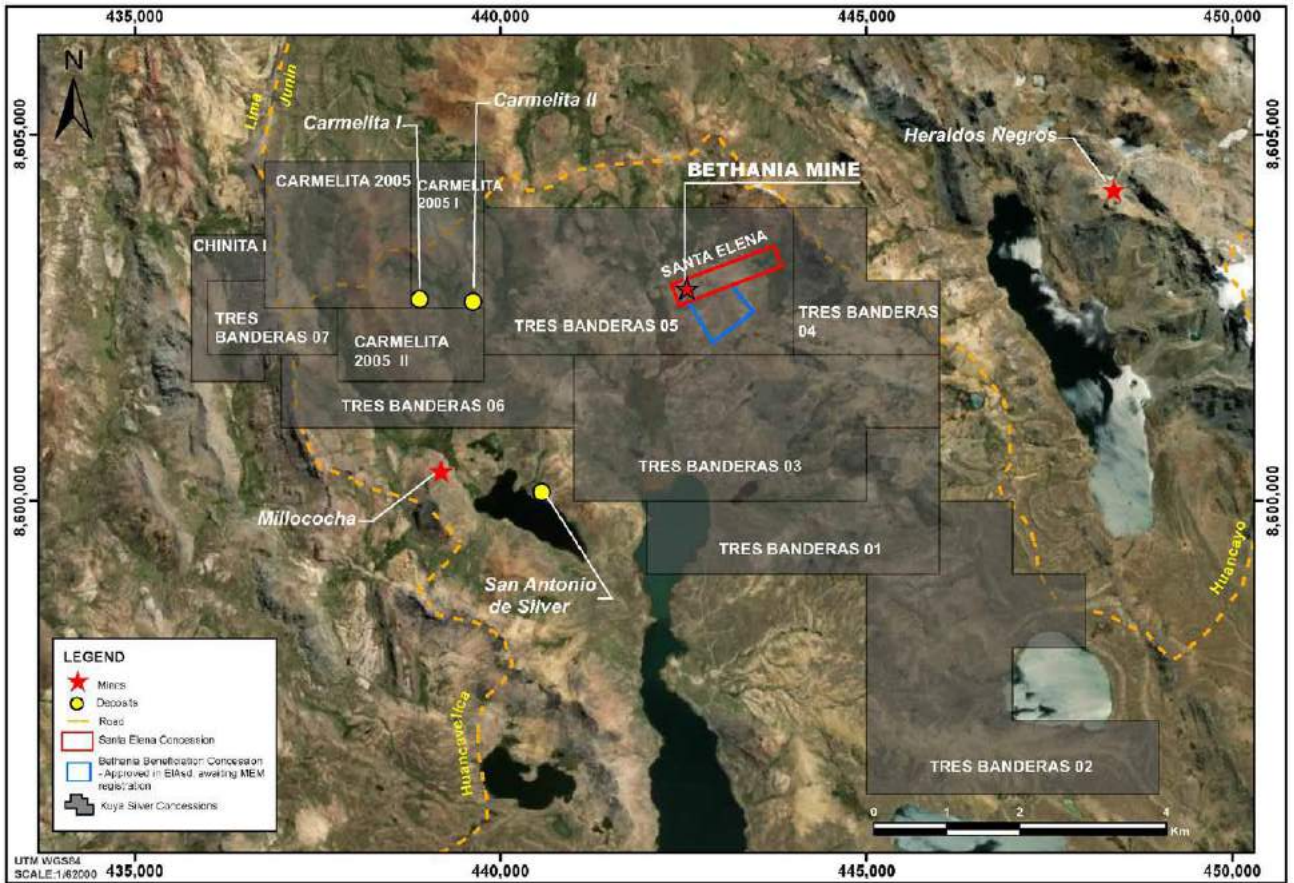

Figure 4-2: Location of the Bethania Mine. Adapted from “NI 43-101 Technical Report & Mineral Resource Estimate” by Caracle Creek International Consulting Inc. February 21st, 2022.

Mines and deposits in the region of the Bethania Silver Project are shown in Table 4-1.

The main mineralized area that is the focus of the Report, is located within the Santa Elena mining concession (11020736X01). Kuya has not undertaken significant exploration work on the other concessions that make up the Project apart from exploration reconnaissance associated with the acquisition of the concessions.

The Santa Elena mining concession, covering 45 hectares (1.5 km x 300 m), is registered to Kuya’s wholly owned Peruvian subsidiary S&L Andes Export S.A.C. (now Minera Toro de Plata S.A.C.) (see Table 4-1 and Figure 4-2). The Santa Elena concession is licensed as a mining concession and was originally registered in 1970 to cover artisanal and colonial-era pits and workings known at the time, including the historical Mina Santa Elena or Santa Elena Mine, now referred to as the Bethania Mine.

The historical Mina Santa Elena had been operating on and off since 1977, with mineral toll treated in several nearby process plants before it was put on care and maintenance in 2016, due in part to the financial position of S&L at that time. The historical Bethania Mine and related infrastructure are centered at approximate UTM coordinates 442766mE, 8603236mN

(PSAD56, UTM Zone 18 South; EPSG:24878) and at about 4,688 meters above sea level (“mASL”).

With respect to the other 11 concessions, the Chinita I concession is registered to Kuya’s wholly owned Peruvian subsidiary S&L Andes Export S.A.C. (now Minera Toro de Plata S.A.C.), the Tres Banderos 01 to 07 are registered to Kuya’s wholly owned Peruvian subsidiary Aerecura Materiales S.A.C. (“Aerecura”) (now Kuya Silver S.A.C.), and Carmelita 2005, Carmelita 2005 I, and Carmelita 205 II were purchased by Kuya Silver S.A.C. but are shown registered to Carmelita 2005, Carmelita 2005 I, and Carmelita 2005 II, respectively (Table 4 1). Updating of the current information on INGEMMET is in process and will be completed in due course.

Assuming the requisite annual investment is achieved and annual “Derecho de Vigencia” (right of validity) payments are made by June 30 each year, concessions are considered irrevocable. Annual holding costs for the 12 concessions is approximately US\$16,000.

Concessions that are listed as “Tramite” are “in process” and in general will be converted to “Titulado” (translation: titled) within one year of their respective application dates if the holder is the sole applicant. In the event of multiple applicants, there is a sealed bid auction process to determine the acquirer. The Company is permitted to undertake exploration work on any concessions that are “Tramite”, while they are in the process of being fully granted (Titulado).

The Authors are not aware of any pending litigation or legal issues or any other issues relating to the Project which would prevent the Company from performing exploration and/or development work on the Project.

#### **4.2.2 Beneficiation Concession**

The Project has an approved EIASd (Directorial Resolution No. 032-0200/GOB.REG.HVCA/GRDE/DREM – issued 21 August 2020) which provides Kuya with the environmental instrument for the location of a 350 tpd capacity process plant and associated infrastructure. The EIASd outlines the area of the Beneficiation Concession. Likewise, inform that the title has been granted to the benefit concession company "Planta Bethania" which comprises 36.39 hectares.

### **4.3 Mining and Environmental Law and Regulations in Peru**

Section 20 contains a detailed overview of the legal framework and specific environmental laws and regulations that mining companies need to follow in Peru. Mining law is discussed below.

#### **4.3.1 Mineral Titles**

Under Peruvian law, the Peruvian State is the owner of all natural resources which includes the mineral resources in the ground. The rights to explore for and develop these mineral resources are granted by means of the “Concessions System”. Mining concessions have the nature of immovable goods.

In Peru, mineral concessions are granted following receipt of a paper application specifying the coordinates of the claim boundaries, based on UTM Zone 18 South (datum WGS 1984) coordinates. All pre-2016 claims were staked using the PSAD 1956 datum but were subsequently converted to the new WGS 1984 coordinate system. All new concessions must use the new grid and must be at least 100 ha in area. Where new claims overlap with older concessions converted to the new system, the older concession has precedence.

Mining concessions are considered immovable assets and are therefore subject to being transferred, optioned, leased and/or granted as collateral (mortgaged) and, in general, may be subject to any transaction or contract not specifically forbidden by law. Mining concessions may be privately owned and the participation in the ownership of the Peruvian State is not required. Buildings and other permanent structures used in a mining operation are considered real property accessories to the concession on which they are situated.

#### **4.3.2 Ownership of Mining Rights**

According to General Mining Law mining concession is irrevocable if the titleholder fulfils the legal obligations required to maintain it in force. However, the titleholder shall comply with the entire obligation to maintain the mining concession valid. General Mining Law provides that mining concessions can be extinguished only by: expiration as a consequence of a failure by a titleholder to pay the mining validity fee and/or penalties for two years (consecutive or not); abandonment as a consequence of the breach of the mining procedure rules applicable to a mining claim; nullity in the case that a mining concession was claimed by an individual or entities that have restrictions according to the mining law; resignation in the case that the titleholder requests the extinction of the mining right; and, cancellation in the case that a mining concession overlaps with priority rights, or when the right is unassailable.

Pursuant to the General Mining Law, mining rights may be forfeited only due to several circumstances defined by law (i.e., non-payment of the maintenance fees and/or noncompliance with the Minimum Production Obligation). The right of concession holders to sell mine production freely in world markets is established. Peru has become party to agreements with the World Bank’s Multilateral Investment Guarantee Agency and with the Overseas Private Investment Corporation.

### **4.3.3 Annual Fees and Obligations**

The mining concession shall be maintained by paying validity fees and complying with the corresponding minimum production obligation (“MPO”). Regarding the obligation to pay the validity fees, the price of these administrative fees depends on the condition of the titleholders (small, artisanal or general regime). Validity fees shall be paid annually to maintain mining concessions in force. The non-compliance of validity fees payment for two consecutive years causes the mining concession to expire.

Pursuant to article 39 of the General Mining Law, title holders of mining concessions pay an Annual Maintenance Fee (Derecho de Vigencia). The Derecho de Vigencia is due on June 30 of each year and is paid once a year in advance and is calculated at US\$3.00 per hectare. Failure to pay Derecho de Vigencia for two consecutive years causes the expiration (‘caducidad’) of the mining concession. However, according to article 59 of the General Mining Law, payment for one year may be delayed with penalty and the mining concessions remain in good standing. The outstanding payment for the past year can be paid on or before the following June 30 along with the future year.

Concession owners must pay US\$3.00 per hectare to file each claim, plus an administrative fee. An annual holding fee of US\$3.00 per hectare is required to maintain the claims, once granted, for the first six years, after which the owner is assessed at twice the annual rate, in addition to the annual holding fee if the property has not been put into production.

### **4.3.4 Surface Rights**

Mining concessions constitute a different right from surface land over it. Owners of surface lands are not authorised to perform mining activities, unless they have a valid mining concession title granted by the INGEMMET. Surface rights are not included in mineral rights, and permission must be obtained in writing from owners and a two third majority of community members when surface rights are owned by local communities, before commencing drilling activities.

The surface lands around the Bethania Mine belong to the Community of Poroche. The Company has a long-term agreement signed with the Poroche which allows them surface access to the 45 hectares of the Santa Elena concession and the Bethania Mine.

In addition, the Company recently signed an addendum to a previous agreement to allow the Company to indefinitely access 36.40 hectares of Poroche lands that constitute the EIA approved Beneficiation Concession area.

Further information on the above community agreements can be found in Section 20.0 (Environmental Studies, Permitting and Social or Community Impact).

#### 4.3.5 *Small – Scale Production*

Small title-holders are entities or individuals holding concessions in an area of less than 2,000 hectares with no more than 350 tonnes per day (“tpd”) of production and must pay a validity fee of US\$1.00 per hectare; artisanal title-holders are entities or persons holding concessions in an area of less than 1,000 hectares with no more than 25 tpd and must pay a validity fee of US\$0.50 per hectare; finally the general regime applicable for entities or persons who do not qualify as small or artisanal and the fees are US\$3.00 per hectare. Validity fees must be paid annually to maintain mining concessions in force. Non-compliance of validity fee payment for two consecutive years results in the extinction of the mining concession.

The Mining Law obligates mining concessions holders to move into production. Currently, two regimes of minimum annual production exist, depending on the date of the mining concession title. Holders of mining concessions that were granted before 2008 will be obliged to achieve minimum annual production from 2019. The two regimes are as follows:

1. Legislative Decree No. 1054 (granted in June 2008) this regime established that mining concessions holders – qualifying under the general regime - need to reach a minimum annual production, equivalent to one tax unit (approximately US\$1,160) per year per hectare. If the holder of mining concession cannot reach such minimum annual production on the first semester of the eleventh year since the year in which the concessions was granted, the holder will be required to pay a penalty equivalent to 10% of the applicable minimum production per year per hectare until the fifteenth year. After the period of 15 years, the mining concessions may remain in force for an additional period of up five additional years in the case of: (i) the holder paying the applicable penalty and securing investments in the mining concession of 10 times the applicable penalty that should be paid; or, (ii) events of force majeure. If the minimum production is not reached after this period has lapsed, the mining concession will inevitably expire.
2. Legislative Decree No. 1320 – (granted in 2017 and in force in 2019) according to this new disposition, mining concessions holders shall reach the minimum annual production, equivalent to one tax unit (approximately US\$1,250) per year per hectare. If the holder of a mining concession cannot reach the minimum annual production in the first quarter of the eleventh year since the year in which the concession was granted, the holder will be required to pay a penalty equivalent to 2% of the applicable minimum production per year per hectare until the fifteenth year. If the holder cannot reach the minimum annual production in the first quarter of the sixteenth year since the year in which the concessions was granted, holder will be required to pay a penalty equivalent to 5% of the applicable minimum production per year per hectare until the twentieth year. If the holder cannot reach the minimum annual production in the first quarter of the twentieth year since the year in which the concessions was granted, the



holder will be required to pay a penalty equivalent to 10% of the applicable minimum production per year per hectare until the thirtieth year. Finally, if the holder cannot reach the minimum annual production until during this period, the mining concession will be automatically expired.

Kuya, whose Santa Elena concession is 45 ha, was previously permitted as a less than 350 tonnes per day producer and as such would be considered a “Small Mining Producer” (“PPM”), requiring them to pay a validity fee of US\$1.00 per hectare (US\$44.90 payable annually).

However, as of 5 May 2021, Minera Toro de Plata S.A.C. lost its PPM status as it incorporated a foreign investor on 15 December 2020. As a result, since 5 May 2021, Minera Toro de Plata S.A.C. is regulated under the General Mining Regime.

Working under the General Mining Regime incorporates a higher level of scrutiny and compliance through central government entities such as the Ministry of Energy and Mines, the Environmental Evaluation and Regulator Regime, Mining Investments Regulatory Regime, and the National Environmental for Sustainable Investments Service, among others as opposed to the PPM which was supervised by local authorities.

#### **4.3.6 Permitting and Regulatory**

Exploration and mining activities on the Santa Elena concession are subject to various Peruvian mining laws, regulations and procedures guided by the Peruvian Political Constitution. Mining Activities in Peru are subject to the provisions of the Uniform Code of the General Mining Law (“General Mining Law”), which was approved by Supreme Decree No. 014-1992-EM (4 June 1992) and its subsequent amendments and regulations, along with other related supreme decrees, laws, directives, and ministerial resolutions. Kuya has obtained a number of permits and licences related to the Santa Elena concession and planned Concentrator Plant along with several permits and licenses that have been approved. (see Regional Directorate Resolution).

#### **4.3.7 Ground Disturbance: Drilling and Trenching**

Companies must obtain a government permit prior to commencing any drilling or major earth moving programs, such as road, drill pad construction or trenching. Depending on the scale of work intended, exploration programs must be presented to the Ministry of Mines, which then will grant an approval to initiate activities provided the paperwork is in order. All major ground disturbances must be remediated and re-contoured following completion of the work activities.

Kuya had secured its drilling permit for their recently completed Phase 1 diamond drilling program (see Section 10). Any future drilling programs will require a new drilling permit.

#### 4.4 Taxation and Foreign Exchange Controls

The following definitions are taken from the “Modelo Económico – Cálculo de Impuestos, PERU, Informe Nro 001 - 2022; Prepared by José Manuel Baca Quiñonez; Effective Date 09 April 2022”, document provided by Kuya Silver.

##### 4.4.1 Credit for accumulated loss

The carryover is a type of Loss Compensation System, in which the Company that has obtained Tax Loss in one fiscal year, can compensate it in the following fiscal years in which it obtains profits. Article 50 of the Income Tax Law mentions 2 Types of Tax Loss Compensation Systems, of which the company Minera Toro de Plata SAC chose to pay system A, where:

- It is allowed to compensate 100% of the net income obtained in the following years.
- The term to exhaust the amount of the Tax Loss is four (4) immediately following fiscal years.

In this case, there is a Balance of uncompensated losses from previous years for US\$ 3,380.00, which would be exhausted in year 0. This amount was reported based on the accounting information and this was clarified on 03/28 /2022, on Form 710 Third Category Annual Income and ITF with order number 1001925865, in box 111.

##### 4.4.2 Profit Sharing

All companies in the private activity regime that:

- Have more than 20 workers.
- That they develop activities that generate third category income, according to the Income Tax Law.

They are obliged to distribute profits to their workers in the mining sector, a rate of 8% corresponds, according to current regulations of net income before taxes, for the purposes of this year they are considered with respect to operating profit.

In effect, the profits distributed to the staff constitute a deductible expense from the income tax (IR) on which the IR is calculated, provided that they are paid before presenting the annual affidavit.

##### 4.4.3 Income Tax (IR)

It constitutes 29.5% of the operating profit discounting deductible expenses, according to article 37 of the TUO of the Income Tax Law (LIR); such as:

- Balance of uncompensated losses from previous years
- Depreciation (it is being considered that 60% of the initial CAPEX will be considered as an expense, while the remaining 40% will become part of the Fixed Asset using its depreciation, according to the useful life of the project)
- Payment of Mining Royalties
- Mine and Plant Preoperative Expenses
- Expenses for the Community
- Mine and Plant closure costs
- Distribution of utilities.

#### **4.4.4 Taxes on Dividends**

Article 73-A of the Income Tax: The legal entities included in article 14 that agree on the distribution of dividends or any other form of distribution of profits, will withhold the corresponding Income Tax from them, except when the distribution is made in favor of domiciled legal persons.

The withholding for the case of legal persons not domiciled is 5%.

#### **4.4.5 Temporary Tax on Net Assets (ITAN)**

Is a tax that must be declared and paid by those who belong to the General Regimes, Micro and Small Business (MYPE), from the amazon, agrarian or establishments in the boundaries Peruvian zone, under certain conditions and with exceptions. 0.4% of the total amount of net assets that exceed one million soles (in this case reference is made to US\$250,000) is applied, according to the Kuya Silver annual balance sheet.

### **4.5 Royalties, Agreements and Encumbrances**

The following definitions are taken from the “Modelo Económico – Cálculo de Impuestos, PERU, Informe Nro 001 - 2022; Prepared by José Manuel Baca Quiñonez; Effective Date 09 April 2022”, document provided by Kuya Silver.

#### **4.5.1 Royalties**

According to Law 29788 in current, the holders of the mining concessions and the assignees who carry out activities of exploitation of metallic or non-metallic mineral resources, as established in the Thirteenth Title of the Single Ordered Text, are subject to the payment of the mining royalty of the General Mining Law.

Impact on Income Tax: the amount actually paid for the concept of Mining Royalty constitutes an expense for income tax purposes in the year in which the royalty is paid. See report No. 014-2022-SUNAT/4B0000.

The mining royalty will be determined quarterly by applying the effective rate indicated in Table 4-3:

*Table 4-3: Royalty Annex*

<b>Royalty Annex</b>			
<b>N°</b>	<b>Operating Margin Range</b>		<b>Marginal Taxes</b>
1	0%	10%	1.00%
2	10%	15%	1.75%
3	15%	20%	2.50%
4	20%	25%	3.25%
5	25%	30%	4.00%
6	30%	35%	4.75%
7	35%	40%	5.50%
8	40%	45%	6.25%
9	45%	50%	7.00%
10	50%	55%	7.75%
11	55%	60%	8.50%
12	60%	65%	9.25%
13	65%	70%	10.00%
14	70%	75%	10.75%
15	75%	80%	11.50%
16	Above 80%		12.00%

The amount to be paid for mining royalties will be greater than the amount resulting from comparing the result of applying the effective rate indicated in the Annex to the quarterly operating profit (the rate is established based on the operating margin of the quarter) and the one percent (1%) of the income generated by sales made in the calendar quarter.

#### **4.6 Environmental Liabilities**

The concept of “mining environmental liability” (‘pasivo ambiental minero’) in the Peruvian mining legal framework specifically refers to the facilities, runoffs, emissions, or remains of former mining operations that, by July 2004 (when the relevant law entered into force), had been abandoned or were inactive and entailed environmental or health hazards.

Peruvian environmental law sets out the general environmental liability rule that the one harming or potentially harming the environment is the one liable for such harm, and thus is the one obliged to prevent, mitigate, repair, or offset such damage. In the same manner, the legal framework on “mining environmental liabilities” sets out the general liability rule that whoever caused a “mining environmental liability” is responsible for its clean up.

Kuya is only responsible for the liabilities within the Santa Elena concession which are documented in their approved mine closure plan and any future impacts caused through mining of the deposit.

Further information on the above environmental liabilities can be found in Section 20.

#### **4.7 Other Significant Factors and Risks**

Peru's recently elected government wants to revise the framework for the country's mining industry, redrafting the umbrella law that regulates the sector, as well as the legislation that sets royalty payments. Draft legislation exists for new closure bond requirements, the draft legislation requires progressive closure to be now included in the closure bonds. Up to now closure bonds did not include progressive closure as this could be undertaken during operations using sustaining Capex. This on average will increase all mine closure bonds for any companies that previously included progressive mine closure in their closure permit. Since this is a draft legislation and not approved to date it is unknown how this may affect the Project. The current government has also indicated that it is willing to find solutions to reduce the permit process timeline which would benefit projects like the Bethania Silver Project.

The Authors are not aware of any other significant factors and risks that may affect access, title, or the right or ability to perform the proposed work program on the Project or the Property.

## 5 ACCESSIBILITY, CLIMATE, LOCAL RESOURCES, INFRASTRUCTURE AND PHYSIOGRAPHY

The Bethania Silver Project is located in the high Andes of Central Peru, in the very northwest area of Huancavelica Department, about 316 km by road from Peru’s capital city of Lima (Figure 5-1). The Project is near the triple junction of the three departments of Lima, Junín, and Huancavelica.

### 5.1 Access to the Property

It is possible to drive to the Property via the Pan Americana Highway South (Route 1S) from Lima, exiting eastward at Cañete/San Vicente (exit 132) toward Route 24, travelling Route 24 to LM-936 and then onto Road 128 north to Bethania (Figure 5-1). This drive covers about 316 km and takes about 6.5 hours to complete. Alternatively, it is possible to fly from Lima to Jauja (Jauja is about 50 km or a one-hour drive from Huancayo) and then drive southwest to the Property via Huancayo (about 4 hours).

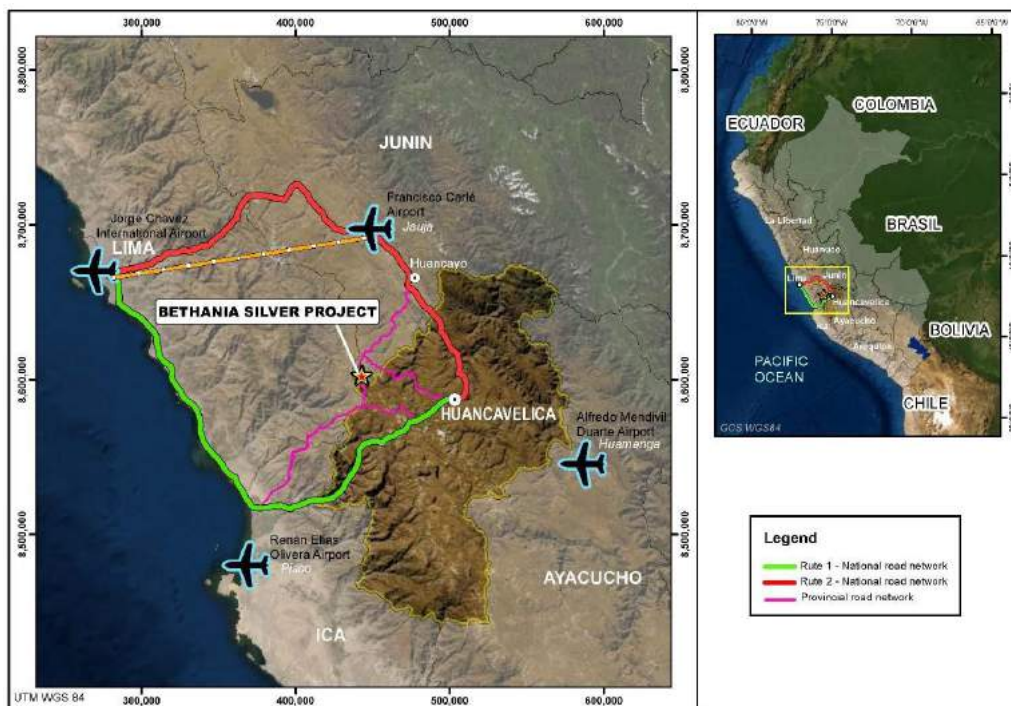

Figure 5-1: Various access routes to travel to the Bethania Silver Project from Lima, Peru. Adapted from “NI 43-101 Technical Report & Mineral Resource Estimate” by Caracle Creek International Consulting Inc. February 21st, 2022.

From Huancayo it is about 120 km to the small village of Bethania, first along a well-maintained paved road to the village of Vista Alegre (~1 hour) and then secondarily along a gravel road that winds its way through the interior to the Property. The drive from the city of



Huancayo to the Bethania Silver Project takes about 3.5 to 4.0 hours and is best accomplished in a 4x4 truck.

**5.2 Climate and Operating Season**

Climate is seasonal with heavy rains typically falling between November and March but does not hinder operations which can be year-round in some capacity. Average annual temperatures in Huancavelica, about 60 km southeast of Bethania Silver Project and at 3700 mASL, are shown in Figure 5-2.

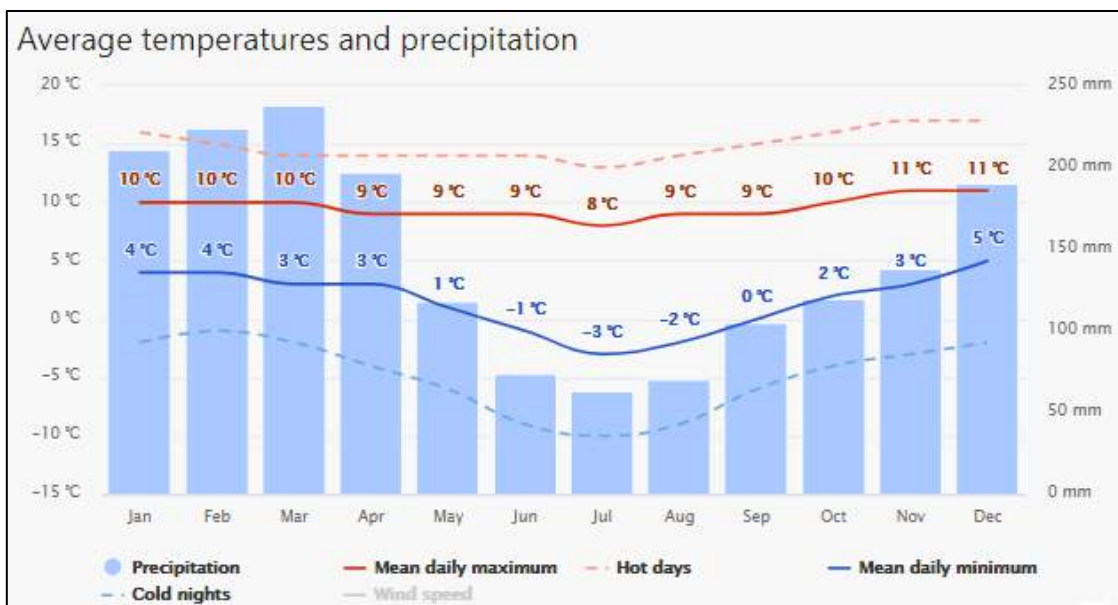

Figure 5-2: Average annual temperatures and precipitation in Huancavelica Department, Peru (online source: meteoblue.com). Adapted from “NI 43-101 Technical Report & Mineral Resource Estimate” by Caracle Creek International Consulting Inc. February 21st, 2022.

There is a difference of 137 mm of precipitation between the driest and wettest months and the variation in temperatures throughout the year is 2.6 degrees Celsius.

**5.3 Local Resources and Infrastructure**

Huancayo (3,259 mASL), with a population of approximately 456,250 (2017 census) and Huancavelica (3,676 mASL), with a population of approximately 49,570 (2017 census), are the nearest significant population centres. These cities offer a range of goods and services, education institutions, and workers well-experienced in mineral exploration and mining (see Figure 5-1).

S&L rents some of the buildings in the village of Bethania Silver Project for accommodation and office space but also have offices and warehouses set up near the mine site itself. Permitted installations include a wastewater pond, fuel storage and explosives magazine.

### 5.3.1 *Water Rights*

The Company through S&L has been granted a water permit by the National Water Authority (dated 11 April 2012) and which is subject to an annual fee of approximately 300 soles (US\$91.00).

Mining industry demands a great percentage of water to develop its activities (such as mineral processing, dust suppression, mud transportation and employee’s needs). As a consequence of that, the Peruvian mining industry has focused its efforts on being appreciated as an activity that makes sustainable use of resources and the environment, including the preservation of water sources.

The National Water Authority (“ANA”) is the entity assigned to the Agriculture Ministry and responsible for granting water rights. The corresponding water rights are the following: (i) licence: it is the right granted in order to use the water to a certain aim and in a determined place, and will be valid until the activity for which it was granted subsists (i.e., beneficiary concession); (ii) permission: it is the right granted in surplus water periods, by which the use of water is eventual and temporal; and (iii) authorisation: this is a right granted only for a period of two years – extended for an additional year – for the execution of studies, construction and land wash (i.e., mining projects). None of these are unlimited nor indefinite. In order to maintain valid water rights, their beneficiary must fulfil certain duties, the main ones being: (i) payment of retribution, water tariff and any other economic obligation; and (ii) allocating the use of water according to the water right requested.

According to the law governing hydrology usage, the water rights cannot be transferred or mortgaged. However, in case the titleholder of the activity or of the surface land who is also the beneficiary of a water right change, the new title holder will be able to initiate a simple procedure to obtain the corresponding water right needing only two requirements: (i) a document that accredit the title in favour of the new one and (ii) accomplish with the payment of the economic retribution.

### 5.3.2 *Electricity*

Approximately 9% of Peruvian territory is supplied with electrical power, however, if energy supply does not reach mining facilities or if the supply is deficient, it is possible for the mining facilities to generate their own energy supply in order to perform their activities. If the power generated is not over 500 kW, it can be made freely without authorization. If the power is over 500 kW it will need the authorization (in the case of thermoelectric generation) or an electrical concession (in case the electric power is generated with renewable natural resources) from the Ministerio de Energia y Minas (“MINEM”).

The Bethania Silver Project does not have any existing power lines with the closest being 5 km and 8 km away. In the past, the mine has relied on diesel generators to provide the



necessary electrical requirements. Kuya Silver's base case considers that electric power will be provided by the connection to the national electric power grid. While the connection to the power grid is being implemented, Kuya Silver will have the option to use a self-generating power source such as natural gas, diesel, or any other alternative source of fuel.

#### 5.4 Physiography

The Bethania Silver Project is characterized by gently rolling topography between 4,691 and 4,858 mASL. Hillsides can be barren of vegetation or populated by short grasses and bushes, valley bottoms are typically more densely vegetated. Transient grazing of various animals is the only recognized farming activity in the area of the Project.

There are several large lakes in the region, some connected by seasonal and/or year-round river systems, including Coyllucocha and Huichicocha (north of the Project), Acchicocha (east of the Project), and Huarmi Chocha, Ujujuy, Millococha, Nahuincocha, Shucullococha, and Astocochoa (south of the Project).

## 6 HISTORY

---

Local verbal information indicates that small scale mining of silver veins at the Mina Santa Elena (later renamed Bethania mine after the local small town), and in the surrounding region, was first carried out in colonial times by Spanish explorers.

More modern exploitation of these veins began in 1977 but was suspended in the 1980's due to political issues in Peru (i.e., terrorism), and subsequently re-started in 2008, and continuing until mid-2016.

Although modern day production at the Mina Santa Elena began in 1977, the earliest confirmed ownership of the Property comes from a 1988 technical report by Minero Bank of Peru, which points to the owner as engineer Heraclio Lopez. This report also refers to a regional study carried out by Minero Bank in 1977 that examined the Bethania – Huarmicocha areas including the historical Santa Elena Mine. The 1988 report by Minero Bank described exploration in the region as minimal and production from the Mina Santa Elena as small-scale, implicating the lack of a nearby concentration plant as the main reason for the mine remaining small. Production methods at this time focused on high-grade, selective mining of the veins.

In 1989, the Property was purchased and transferred to company S&L Andes Export S.A.C., owned by the Soria family (Peru). Historical surface and underground exploration on the Property by S&L (2008-2016) was limited to geological and structural mapping, and rock sampling, trenching and sampling, and the drilling of short “pack sack” drill holes. The general locations and projections of some of these packsack drill holes are shown on historical mine level plans but no other data or information on this drilling is available.

On 16 December 2020, Kuya Silver Corporation (from now on Kuya) announced it had acquired 100% of the Bethania Silver Project from S&L and renamed S&L to Minera Toro del Plata S.A.C. (wholly owned Peruvian subsidiary of Kuya). Aerecura Materiales S.A.C., a current registered holder of some of the adjacent concessions that make up the Bethania Silver Project, was renamed Kuya Silver S.A.C. (a wholly owned Peruvian subsidiary of Kuya).

No other surface exploration is known to have been completed on the Santa Elena concession prior to Kuya taking over the Property.

### 6.1 Historical Mine Production

S&L has provided documentation on underground exploration and development of the veins in the historical Mina Santa Elena, now named the Bethania Mine (e.g., Milla and Osorio, 2016). Exploration for vein extensions, vein splays and new veins was a continuous part of the mining plan/program at the historical Mina Santa Elena.

However, it is later indicated that not enough mine preparation work had been completed once the known mineralization was becoming worked out down to the bottom producing 670 level at the 4690 elevation, even though there were good indications that mineralization continues in depth.

This and a cessation of toll treatment at Azulcocha mine forced the owners to put the mine on care and maintenance in mid-2016. Table 6-1 summarizes the recorded mine production from 1977-2016. The grades are typical of many of the small narrow silver vein mines in Peru.

*Table 6-1: Summary showing the historical Bethania Mine mined tonnes and grades (1977-2016)*

Years	1977 - 1988	2008 - 2009	2010	2011	2012	2013	2014	2015	2016	1977 - 2016
Operating Company	Sierra Nevada	San Antonio	S&L Andes S.A.A							Total
Production tonnes	12,700	11,390	4,100	6,890	9,136	21,500	28,789	17,885	2,717	115,107
tonnes / day*			16	28	37	86	115	72	11	
Ag (Oz/t)	16.18	14.88	20.17	25.61	21.32	14.39	13.10	16.33	9.63	15.93
% Pb	4.30	6.98	10.20	8.51	7.69	3.31	2.07	4.05	3.51	4.50
% Zn	3.93	2.09	1.40	2.90	3.26	2.30	1.99	2.89	1.29	2.53

(\*) Note: Average daily tonnage based on 250 working days per year

## 6.2 Historical Mineral Resource and Mineral Reserve Estimate

S&L calculated its own internal mineral resources and mineral reserves estimates (Milla, 2016a; Milla and Osorio, 2016) for planning purposes, and at times to promote investment in the mining operation. Estimates made on six (6) veins by Milla (2016a) are summarized in Table 6-2 and Table 6-3.

*Table 6-2: Historical Mineral Resources, Bethania Mina, March 2016 (Milla, 2016a)*

Resources Category	Tonnes (t.)	Ag (oz/t)	Pb (%)	Zn (%)	Cu (%)	Ag (contained oz.)
Measured	67,710	15.94	4.39	2.50	0.25	1,190,033
Indicated	260,528	15.96	4.46	2.50	0.25	4,583,063
Inferred	132,964	14.94	4.94	2.94	0.30	2,195,573
<b>Total (Measured + Indicated)</b>						<b>5,773,096</b>
<b>Total (Inferred)</b>						<b>2,195,573</b>

*Table 6-3: Historical Mineral Reserves, Bethania Mina, March 2016 (Milla, 2016a)*

Reserves Category	Tonnes (t.)	Ag (oz/t)	Pb (%)	Zn (%)	Cu (%)	Ag (contained oz.)
Proven	67,710	15.94	4.39	2.50	0.25	1,190,033
Probable	41,444	15.28	4.73	2.96	0.27	698,243

These historical estimates were prepared by Dionicio Milla Simon- CIP 46162- (Geological Engineer), as documented in a report titled, “Mina Santa Elena Estimación de Recursos y Reservas Minerales”, dated March 2016, and were calculated using simple block modelling for partially developed and measured stope blocks and larger indicated and inferred resource blocks extended in depth, using sampling data collected along the backs of the development levels.

Development on veins was methodically and consistently sampled and assayed for Ag, Pb and Zn, and the width of each vein sample and location is recorded. Copper was assayed only intermittently, and more sampling is required in order to include copper in any future mineral resource or mineral reserve estimates. No cut-off grade was provided, but a specific gravity (density) of 3.0 and a dilution factor of 5% were applied.

Mineral reserve estimates considered mineralized material that was immediately accessible above and below existing mine workings and was calculated exclusive of mineral resources.

The historical estimates are not considered current resources and are not consistent with NI 43-101 as they lack up-to-date sampling, sample preparation and assaying QA/QC support, and their estimation limits determined through robust geostatistical estimation. There are no recent estimates or data available to the Company with respect to these historical estimates.

It should be noted that the Measured resources category in Table 6-2 converts to the Proven reserves category without change, and that 84% of the tonnages stated in Table 6-2 and Table 6-3 comes almost equally from the two main veins, Veta 12 de Mayo and Veta Española. In addition, in comparing Table 6-2 to Table 6-3, the estimated Measured/proved mineral grades are very similar to the actual mine grades. However, Indicated and Inferred tonnage estimates may be much lower because prior to 2021, no diamond-drilling had been carried out to confirm down-dip continuation of the veins.

Verification of the historical mineral resource and reserve estimates would require systematic diamond drilling in the area of the historical estimates in order to generate a statistically significant number of samples of the historical resource and reserve blocks. Future mineral resource and reserve estimates would also benefit from the re-sampling of the bottom 4640 Level of the mine.

A qualified person has not done sufficient work to classify the historical estimates as current mineral resources or mineral reserves and Kuya is not treating the historical estimates as current mineral resources or mineral reserves.

Investors should not therefore rely on the historical estimates as current mineral resources or mineral reserves until they have been verified and supported in a technical report in accordance with NI 43-101. Furthermore, the conversion of mineral resources to mineral reserves requires a mine plan, and there is at present no workable mine plan with these historical resources.

### 6.3 Historical Toll Processing Information

During the period 2013-16 in-mine selected high-grade mineral was either trucked to the nearby Heraldos Negros (San Valentin) plant for toll treatment or trucked to a storage yard in Huancayo from which it would be trucked to other plants at greater distance.

Table 6-4 records the monthly production reported to the Ministry of Energy and Mines for the period 2013-2018. This indicates toll treatment during most months up to near the end of 2015, and then only January, February, and a smaller shipment in August. Table 6-5 records the toll milling tonnes treated and recoveries (lead-zinc concentrates) from 2013 to 2016.

*Table 6-4: Monthly production reported to the Ministry of Energy and Mines for the period 2013-2016*

Kg. Ag	J	F	M	A	M	J	J	A	S	O	N	D	Total	Total Oz. Ag
2013	-	828	622	622	942	575	889	267	642	700	856	613	7,556	242,932
2014	627	569	-	602	-	724	810	939	1,471	874	1,130	659	8,405	270,228
2015	421	854	765	283	228	435	530	735	542	-	945	-	5,738	184,481
2016	627	384	-	-	-	-	-	350	-	-	-	-	1,361	43,757
													<b>Total Oz. Ag</b>	<b>741,398</b>

Tonnes. Pb	J	F	M	A	M	J	J	A	S	O	N	D	Total	Total
2013	-	66	46	46	56	43	70	25	61	55	96	72	636	<b>1,726</b>
2014	70	57	-	31	-	41	47	47	68	35	48	32	476	
2015	22	38	44	29	23	46	59	68	65	-	86	-	480	
2016	50	38	-	-	-	-	-	46	-	-	-	-	134	

Tonnes. Zn	J	F	M	A	M	J	J	A	S	O	N	D	Total	Total
2013	-	64	35	35	34	22	24	15	23	20	29	31	332	<b>1,166</b>
2014	26	32	-	34	-	41	36	39	46	39	56	37	386	
2015	27	46	62	19	27	30	34	52	39	-	58	-	394	
2016	28	18	-	-	-	-	-	8	-	-	-	-	54	

Table 6-5: Summary of toll milling tonnes treated and recoveries (lead-zinc concentrates) 2013 to 2016, Bethania Mine.

Process Information					Recovery (Lead Concentrate)							
Year	Deliveries	Plant	Delivered (t.)	Lead Concentrate (t.)	Ag (oz)	% R	Pb (t.)	% R	Zn (t.)	% R	Cu (t.)	% R
2013	11	Minera Peru Sol - Huari Minera San Valentin - Yauyos	20,235.10	1,331.69	207,405.85	87.84	587.48	92.91	135.01	42.55	-	
2014	50	Minera San Valentin - San Pedro	24,753.65	1,023.83	253,052.08	85.55	485.93	89.20	58.56	25.58	2.85	74.15
2015 2016	43	Minera San Valentin - San Pedro Mina Azulcocha Zinc	16,620.50	843.22	187,528.92	83.01	539.94	93.83	65.57	14.97	28.68	73.18
		<b>Total</b>	<b>61,609.25</b>	<b>3,198.74</b>	<b>647,986.85</b>		<b>1,613.35</b>		<b>259.14</b>		<b>31.53</b>	

Process Information					Recovery (Lead Concentrate)							
Year	Deliveries	Plant	Delivered (t.)	Zinc Concentrate (t.)	Ag (oz)	% R	Pb (t.)	% R	Zn (t.)	% R	Cu (t.)	% R
2013	11	Minera Peru Sol - Huari Minera San Valentin - Yauyos	20,235.10	351.88	6,513.13	2.76	12.11	1.92	123.82	39.02	-	-
2014	50	Minera San Valentin - San Pedro	24,753.65	661.11	19,230.60	6.68	16.45	3.27	325.58	63.79	4.57	8.76
2015 2016	43	Minera San Valentin - San Pedro Mina Azulcocha Zinc	16,620.50	626.76	21,165.26	9.17	8.49	1.56	322.40	75.54	4.65	11.65
		<b>Total</b>	<b>61,609.25</b>	<b>1,639.75</b>	<b>46,908.99</b>		<b>37.05</b>		<b>771.80</b>		<b>9.22</b>	

## 7 GEOLOGICAL SETTING AND MINERALIZATION

---

### 7.1 Regional Geology

The Bethania Silver Project is located over the Cordillera Central, which contains prolific and prospective base and precious metals belts. The locations of known and historic mines, in a regional setting, is provided in Figure 7-1, comprising numerous styles of mineralization including epithermal Au-Ag, porphyry Cu-Au-Mo, and replacement/skarn Zn-Cu. Peru is the second largest silver producer in the world with approximately 50% of silver production associated with gold production and 50% associated with base metal/polymetallic mines.

The geological, mining, and metallurgical institute (“INGEMMET”) publish geological maps covering much of Peru at 1:100000 and 1:50000 scales. INGEMMET also publish descriptive bulletins (“Boletíns”) detailing regional geology, lithological units, structure, and economic geology for much of Peru.

The Project area is located on National Topographic (1:100K) sheets 26-L (Tupe) and 26-M (Conaica), covered by geological report and maps in Bulletins 44 (Salazar and Landa, 1993) and 73 (Morche and Larico, 1996), respectively. Key regional geological features related to these maps sheets and the Project area include (Figure 7-2):

- Mesozoic sedimentary rocks (Cretaceous) folded along an NNW trend.
- Andean-trending, NNW faulting in part controls exposure of older sedimentary and volcanic sequences.
- Andesitic intrusions related to Cenozoic volcanism (Coastal Batholith) are exposed.
- Intrusives related to the Coastal Batholith are exposed in and around the Project area.
- A disconformity exists between the upper Mesozoic (Cretaceous) formations and the lower formations of the Cenozoic (Tertiary) formations.
- Varied quaternary deposit are concentrated along water courses and valley bottoms.
- Bethania Mine is located along an interpreted major north-northeast fault line, expressed through regional topography and the geometry of Laguna Huarmicocha.
- Bethania Mine and other deposits, occurrences and mines in the immediate area are interpreted to be located within an ancient volcanic caldera.
- The Property is situated in the northern region of the Southern Peru Au-Ag Epithermal Belt, hosted largely by Tertiary-age volcanic rocks.



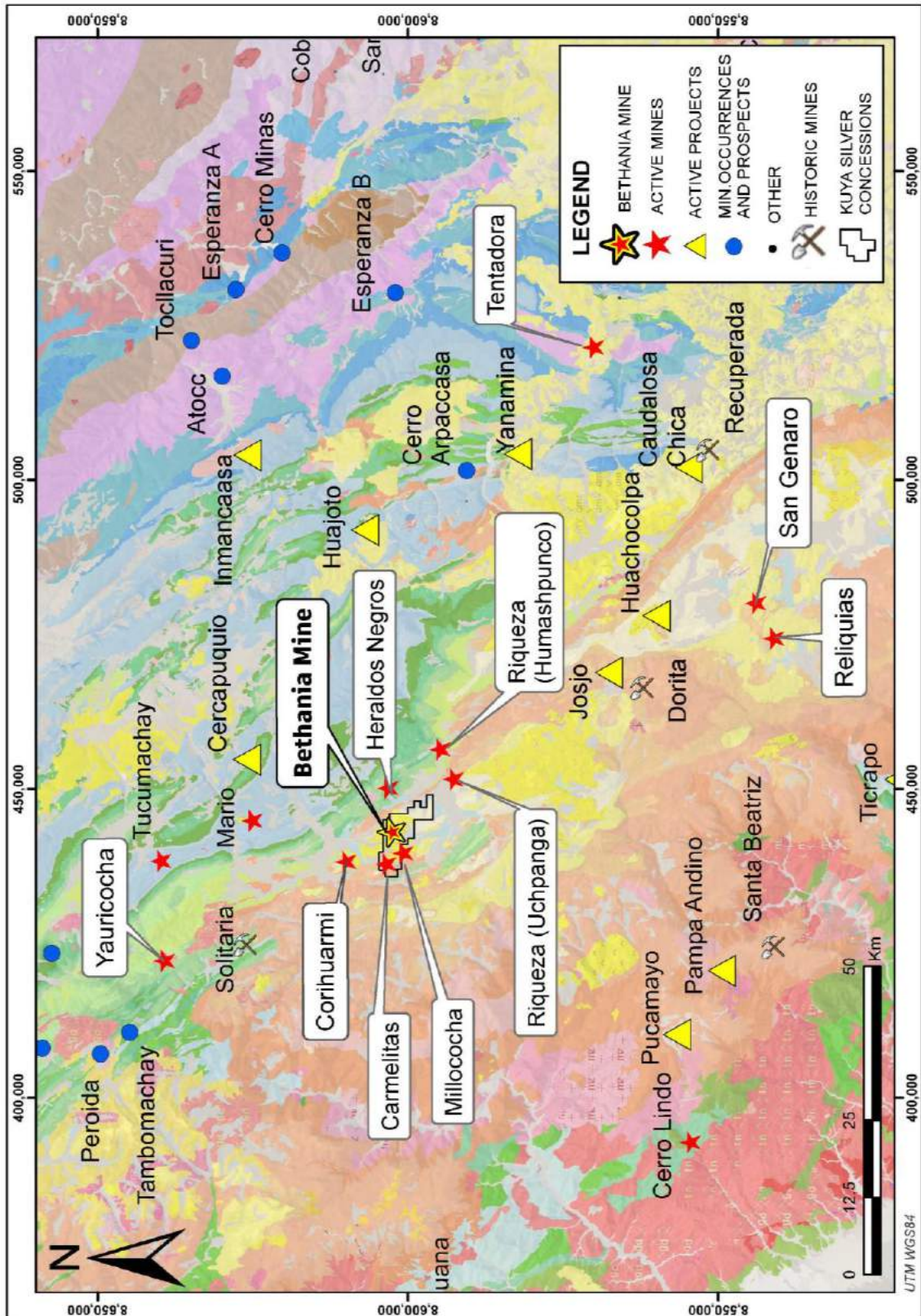

Figure 7-1: Regional geology of Peru showing the location of the Bethania Silver Project in the Cordillera Central, along with past and current producing mines.



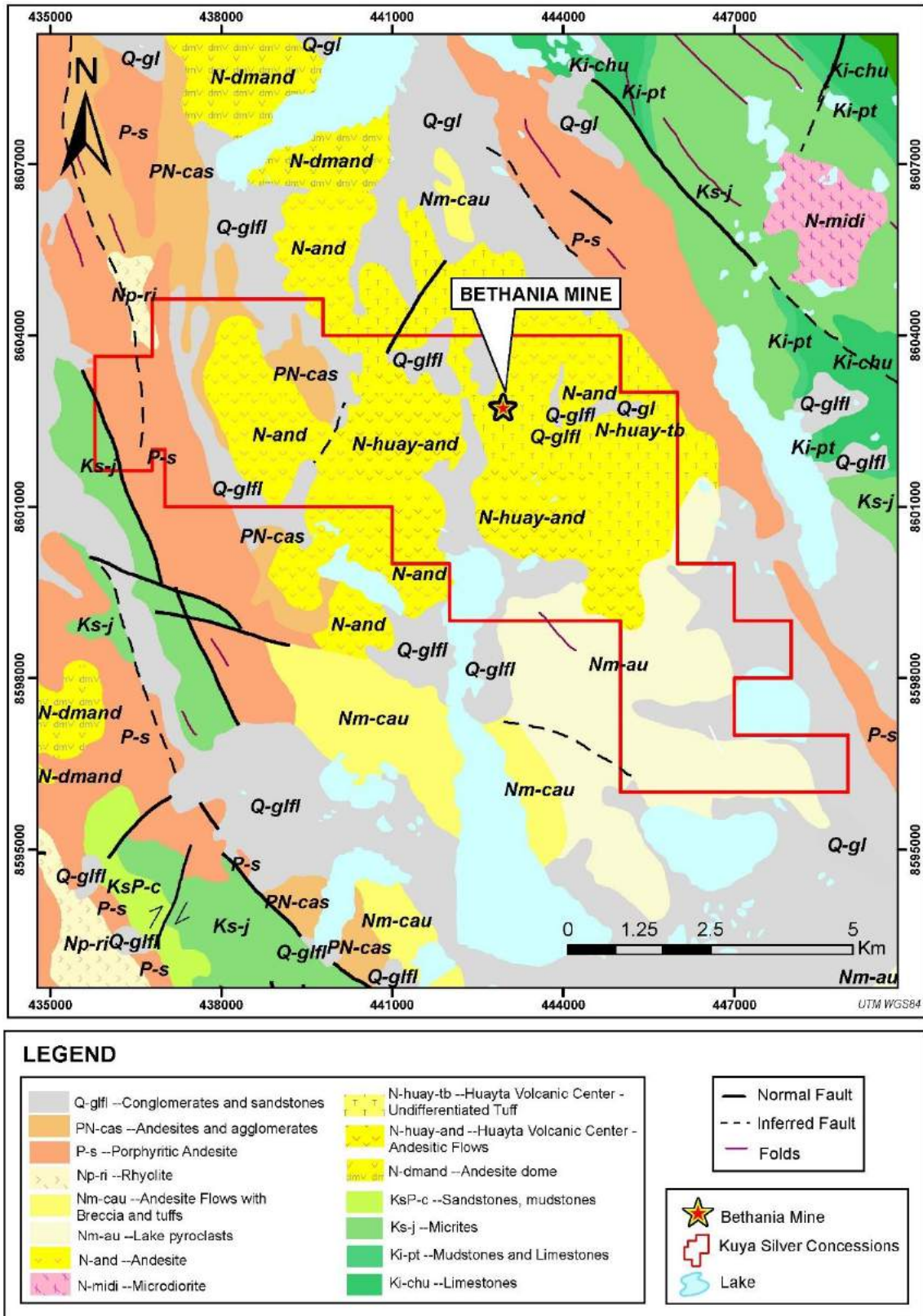

Figure 7-2: Project-scale geological map with the general outline of the 12 properties that make up the Bethania Silver Project (source geology: INGEMMET Bulletins 44 and 73)

## 7.2 Property and Local Geology

The Santa Elena mining concession covers Tertiary volcanic rocks that include andesite, dacite, and tuff (see Figure 7-2; Figure 7-3). Outcrop exposure is best in areas of higher elevation (high cliffs, hill tops etc.) and along road or stream cuts, with much of the region covered by vegetation and Quaternary deposits (overburden).

All of the mineralized veins discovered to date are hosted by altered andesite and/or dacite with some anomalous mineralization hosted by siliceous bodies of stockwork quartz-breccia. The attention of past on-vein exploitation focused on the east-northeast trending veins but there are numerous north-northwest trending veins that have seen little if any exploration and testing. All of the known veins on the Santa Elena concession are listed in Table 7-1.

*Table 7-1: Known veins and their characteristics, Santa Elena mining concession*

VEIN	STATUS	Average azimuth	Average Dip	Length (m)	Average width (m)	COMMENTS
Española 1	Focused exploitation	60	75-86 SE	500	± 0.6m.	Main structure: length defined in underground workings
Española 2	Focused exploitation	280	60-88 SW	200	NA	NE end of concession: length shown by underground workings
12 de Mayo	Focused exploitation	60	75-86 SE	550	± 0.6m.	Main structure: length defined in underground workings
Ramal 12 de Mayo	Focused exploitation	70	70-85 NW	100	± 0.3m.	Intersects Victoria vein underground and does not continue
Victoria	Focused exploitation	60	79-90 SE	110	± 0.4m.	Main structure: displaces 12 de Mayo and Ramal 12 de Mayo
Carolina	Limited exploration	60	70-80 SE	100	± 0.2m.	Tension structure to Español 1 vein; mapped at surface
Betsaida	Limited exploration	95	70-75 NE	100	NA	Intersects with Caroline vein; mapped at surface
Maria	Limited exploration	90	75-86 SE	60	± 0.4m.	Likely tensional to Española 1 in hanging wall
Rocio	Limited exploration	290	85 NE	95	NA	NE end of concession: length mapped at surface
Santa Elena	Limited exploration	279	60-70 S	45	NA	NE end of concession: length shown by underground workings
Yolanda	Limited exploration	66	68 NW	30	NA	Parallel to 12 de Mayo vein; mapped at surface

The total lengths of the vein systems are not clear for all the veins and there is evidence that the northeast-trending veins (e.g., Española and Carolina) could extend several hundred meters along strike. In addition, many of the veins continue at depth as evidenced from

underground mine development and the recently completed Phase diamond drilling program.

Ausenco (2017), noted that geochemical results indicate the potential for an igneous body of the copper porphyry type existing at depth, suggesting the possibility for deeper copper dominant mineralization. Work in the immediate area of the Santa Elena concession provides evidence for a porphyry system underlying the area including drilling by Minera IRL Limited. Furthermore, satellite imagery suggests that the Bethania Mine and Santa Elena mining concession vein system are almost central to what appears to be a wide zone of alteration sitting centrally within what appears to be an 11 km wide collapsed caldera, indicating a much bigger exploration target both laterally and at depth (Figure 7-4). There are similarities here with the 15 km wide collapsed caldera that surround the San Genaro and Reliquias mines 70 km to the south of the Project.

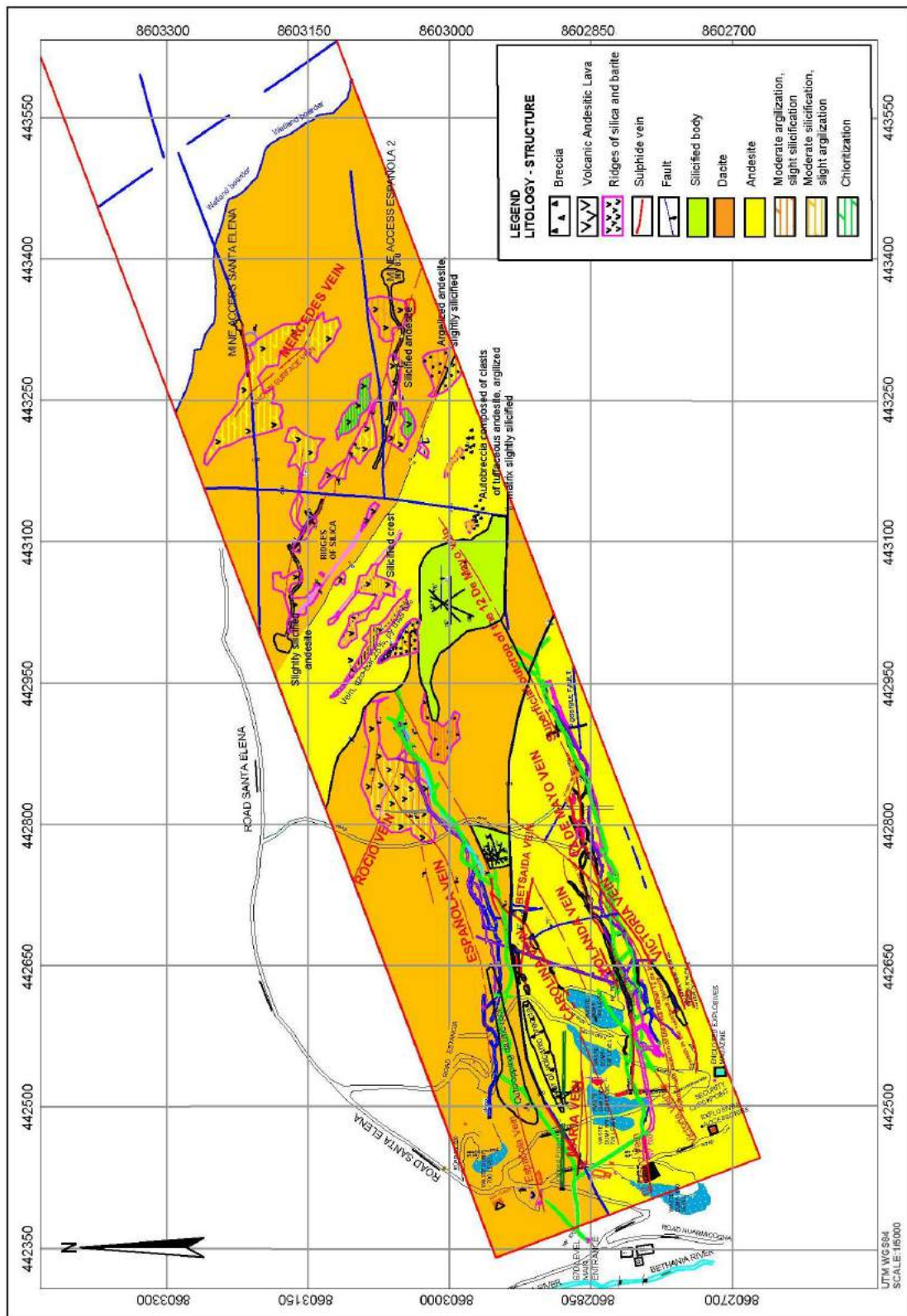

Figure 7-3: Property-scale geological and structural map of the Santa Elena concession (Bethania Mine); dacite (orange), andesite (yellow), siliceous body (green) (source: Milla, 2016a).



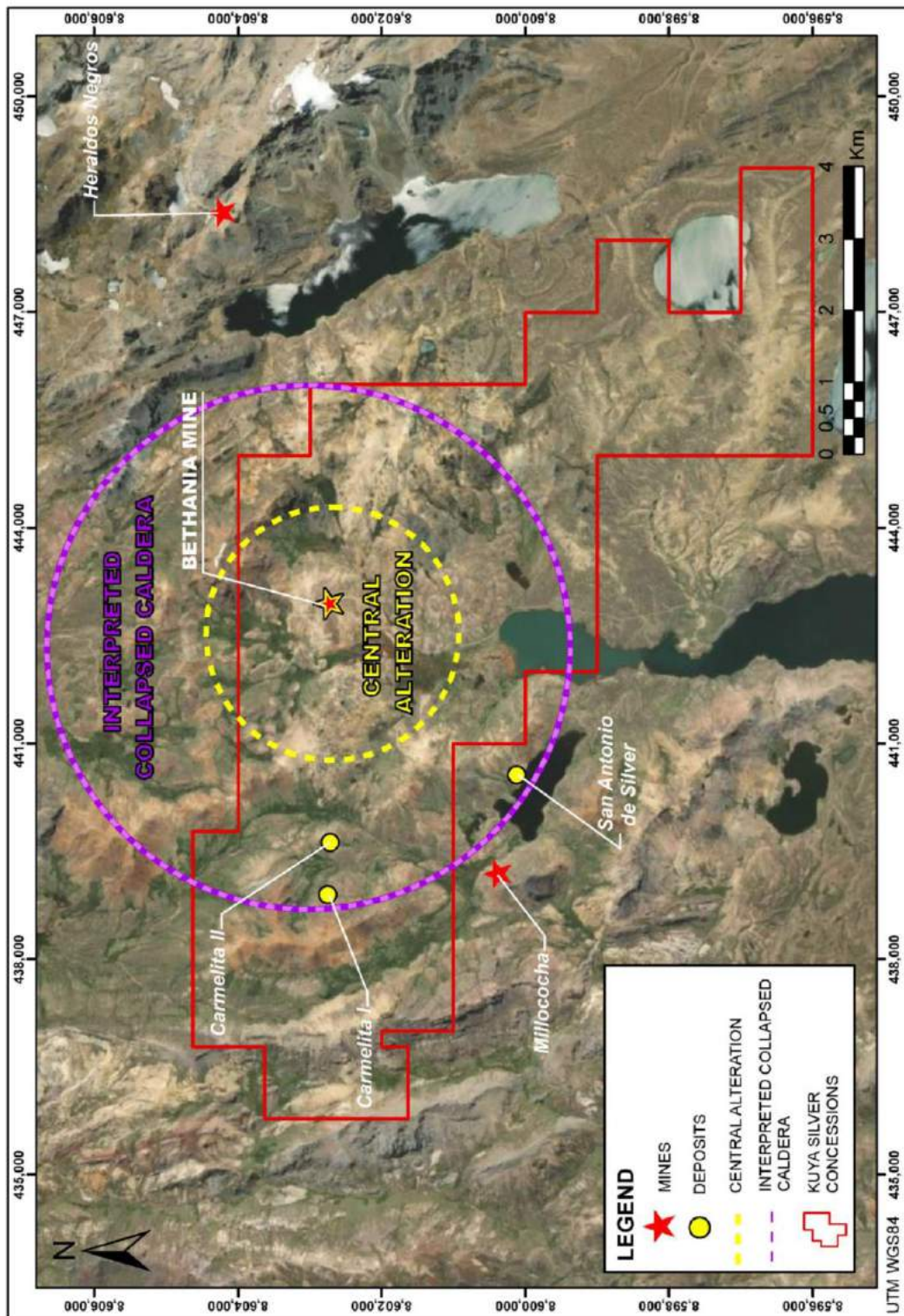

Figure 7-4: Satellite imagery suggests that the vein system in the Santa Elena mining concession (Bethania Mine) are almost central to what appears to be a wide zone of alteration sitting centrally within what appears to be an 11 km wide collapsed caldera, indicating a much bigger exploration target both laterally and at depth. The red outline marks the general boundary of the Project concessions.

### 7.2.1 Lithology

A list of the main lithologies that underlie the 12 properties, along with a summary of their characteristics, is provided in Table 7-2.

*Table 7-2: Summary of the main lithologies underlying the 12 properties, Bethania Silver Project*

Name	Formation	Units	Sub-Unit	Description
Santa Elena	Auquivilca	N-huay-tb	Ts-a	tuff
Santa Elena	Auquivilca	N-and	T-a	diorite
Santa Elena	Surficial Deposits	Q-glfl	Qr-g	overburden
Chinita I	Jumasha	Ks-j	Ks-j	limestone
Chinita I	Sacsaquero	P-s	Tm-ss	andesite porphyry
Tres Banderas 01	Astobamba	N-huay-and	Ts-as	andesite
Tres Banderas 01	Auquivilca	Nm-au	Ts-a	tuff/breccia
Tres Banderas 01	Surficial Deposits	Q-glfl	Qr-g	overburden
Tres Banderas 02	Surficial Deposits	Q-gl	Qr-g	overburden
Tres Banderas 02	Auquivilca	Nm-au	Ts-a	tuff/breccia
Tres Banderas 03	Auquivilca	Nm-au	Ts-a	tuff/breccia
Tres Banderas 03	Auquivilca	N-huay-and	Ts-as	andesite
Tres Banderas 04	Surficial Deposits	Q-glfl	Qr-g	overburden
Tres Banderas 04	Auquivilca	N-huay-tb	Ts-a	tuff
Tres Banderas 04	Auquivilca	N-and	T-a	diorite
Tres Banderas 05	Surficial Deposits	Q-glfl	Qr-g	overburden
Tres Banderas 05	Castrovirreyna	PN-cas		andesite/agglomerate
Tres Banderas 05	Auquivilca	N-huay-and	Ts-as	andesite
Tres Banderas 06	Surficial Deposits	Q-glfl	Qr-g	overburden
Tres Banderas 06	Auquivilca	N-huay-and	Ts-as	andesite
Tres Banderas 06	Auquivilca	N-and	T-a	diorite
Tres Banderas 07	Surficial Deposits	Q-glfl	Qr-g	overburden
Tres Banderas 07	Sacsaquero	P-s	TM-ss	andesite porphyry
Tres Banderas 07	Castrovirreyna	PN-cas		andesite/agglomerate
Carmelita 2005	Surficial Deposits	Q-glfl	Qr-g	overburden
Carmelita 2005	Auquivilca	N-and	T-a	diorite
Carmelita 2005	Castrovirreyna	PN-cas		andesite/agglomerate
Carmelita 2005 I	Surficial Deposits	Q-glfl	Qr-g	overburden
Carmelita 2005 I	Auquivilca	N-and	T-a	diorite
Carmelita 2005 I	Castrovirreyna	PN-cas		andesite/agglomerate
Carmelita 2005 II	Surficial Deposits	Q-glfl	Qr-g	overburden
Carmelita 2005 II	Auquivilca	N-and	T-a	diorite
Carmelita 2005 II	Castrovirreyna	PN-cas		andesite/agglomerate

### 7.2.2 Structure

There are a number of high-angle, northeast-, northwest-, and north-south-trending fault systems on the Santa Elena concession. Principal veins of economic interest are oriented east-northeast (~60Az) and dip from approximately 70 degrees to the southeast to near vertical.

### 7.2.3 Alteration

Hydrothermal alteration observed on the Property includes silicification, sericitization, chloritization, and tourmalization, with silicification immediately associated with economic vein mineralization. Argillic alteration (clay) occurs away from the veins and chloritic alteration more distal to the veins. Stein (2018), was of the opinion that geological controls, such as alteration, have not been studied in any great detail.

## 7.3 Mineralization

Given the lithological, structural, mineralogical and alteration characteristics observed at the Project and specifically in the Bethania Mine vein system, mineralization identified to date can be classified as volcanic-associated, polymetallic intermediate sulphidation epithermal (“ISE”), with significant accumulations of silver, lead, zinc, copper, and gold.

Dominated by silver, Bethania Mine’s polymetallic mineralization is fairly typical in its composition, containing appreciable amounts of lead, zinc, gold, and copper. On the basis of multi-element assays and production history, it is clear that dominant sulphide minerals include silver sulfosalts (e.g.,  $\text{Ag}_3\text{AsS}_3$ ,  $\text{Ag}_3\text{SbS}_3$ ), galena ( $\text{PbS}$ ), sphalerite ( $\text{ZnS}$ ), and chalcopyrite ( $\text{CuFeS}_2$ ).

Mineralization of the major veins, Española and 12 de Mayo, can be more than 1.5 meters thick, but averages are about 0.6 meters; minor veins average about 0.3 meters in thickness.

## 8 DEPOSIT TYPES

---

Currently accepted definitions of epithermal deposits include precious and base metal deposits forming at depths of <1.5 km and temperatures of <300 degrees Celsius in subaerial environments within volcanic arcs, at convergent plate margins and in intra- and back-arc as well as post collisional extensional settings. Epithermal systems can be grouped into high, intermediate, and low sulphidation types based on variations in their hypogene sulfide assemblages (e.g., Sillitoe and Hedenquist, 2003; Corbett, 2007). Most epithermal gold deposits are Cenozoic in age and although some older deposits are known, none of the giant mineralized material deposits of this type are older than Cretaceous.

The Bethania silver deposit is a polymetallic (Ag-Pb-Zn-Cu-Au) hydrothermal deposit whose mineralogy, mineralization, textures, and associated alteration phases are consistent with the intermediate sulphidation (IS) epithermal geological model for volcanic-hosted precious metal deposits (Figure 8-1).

### 8.1 Intermediate Sulphidation Epithermal Deposits

Epithermal gold and silver deposits of both vein and bulk-tonnage styles may be broadly grouped into high-, intermediate-, and low-sulphidation types based on the sulphidation states of their hypogene sulfide assemblages (Sillitoe and Hedenquist, 2003). Intermediate sulphidation epithermal deposits are one of the subtypes of epithermal deposits (i.e., a subtype of low sulphidation type) formed in subduction-related arc settings or post-collisional orogenic belts and an essential component of porphyry-epithermal systems. Economically significant in terms of their polymetallic mineralization (i.e., Ag-Au-Pb-Zn-Cu), IS deposits typically have a close relationship with andesitic-dacitic volcanic-subvolcanic rocks, usually related to oxidized calcic to calc-alkaline magmatism and formed at depths between 300 meters and >1 kilometer (Wang et al., 2019).

General characteristics of ISE deposits include:

- Generally, veins and breccias like low sulphidation systems but with coarser banding.
- May contain alunite like high sulphidation systems.
- Usually contain significant silver with gold and lead (galena), zinc (sphalerite), copper (chalcopyrite) at depth.
- Gold and silver deposition is controlled by boiling whereas base metal deposition by fluid mixing and/or cooling.
- Indications of boiling are reflected in the replacement of calcite by silica.

Sillitoe and Hedenquist (2003), indicate that intermediate and low sulphidation epithermal (“LSE”) deposits have been found to be mutually exclusive mainly in the tectonic setting of formation. However, there is growing evidence that some deposits exhibit composite



characteristics of both ISE and LSE mineralization styles (e.g., Camprubi et al., 2006; Carillo et al., 2003). Given that characteristics of high sulphidation epithermal (“HSE”) systems are also noted in ISE systems, it is more likely that a continuum exists between ISE and LSE systems and between ISE and HSE systems.

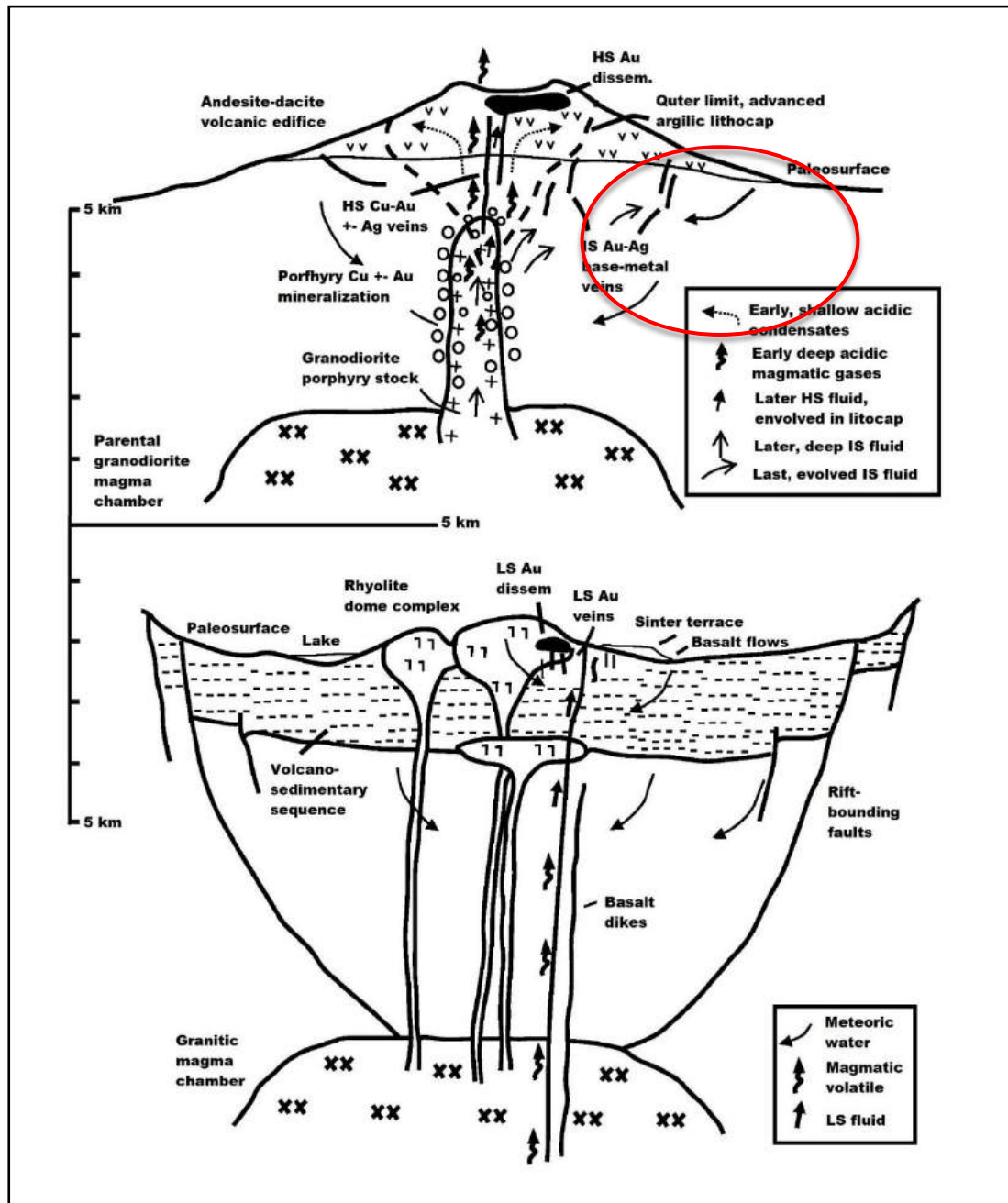

Figure 8-1: Generalized epithermal deposit models showing the various subtypes – low, intermediate and high sulphidation – in (a) volcanic setting and (b) rift setting (Sillitoe and Hedenquist, 2003). An approximation of the location of the volcanic associated Bethania Mine mineralization is circled in red.

## 9 EXPLORATION

---

Prior to 2019, there had been no systematic surface or underground exploration at Bethania. The historical Mina Santa Elena, now the Bethania Mine, was put on care and maintenance in 2016 and so prior to 2019, there had been no systematic surface or underground exploration by the Issuer on the Project or the Property (Santa Elena concession).

Kuya initiated data and information compilation in 2019, completing a high-resolution drone-based high resolution elevation survey in April 2019, announced the results of surface vein sampling in April 2021, and completed a 4,988.05 m diamond drilling program, with final assay results announced July 2021 (see Section 10). Over the course of 2021, Kuya also conducted surface sampling over parts of the Santa Elena mining concession, as described below.

Exploration to date by the Issuer has focused on the Santa Elena mining concession (45 ha) which covers the Bethania Mine; the other 11 concessions that comprise the rest of the Project have not been explored by the Issuer.

Other than surface prospecting and sampling, there is no other exploration work being conducted on the Project at this time.

### 9.1 High-Resolution Elevation Drone Survey (2019)

In April 2019, ACOMISA completed a photogrammetric report using data collected from a high-resolution drone survey over the Santa Elena concession (Bethania Mine). Elevation models produced from the data include contour intervals of 0.5 and 1.0 meters.

### 9.2 Data Compilation and Review (2019)

In mid-2019, the Company engaged Orix Geoscience Inc. (“Orix”) of Toronto, Canada to complete data compilation and a review of all public and private information from the Project including 2D compilation (GIS database), 3D compilation (Leapfrog), and geological modelling (3D) with associated recommendations:

- Create an ArcGIS 2D Compilation of all publicly available data as well as data provided by Kuya Silver.
- Re-project, georeference and digitize available geological interpretation completed by the team in Peru.
- Import all relevant and available digital data into a 3D platform (Leapfrog).
- Use surface geological interpretation to create simplified geological model.
- Use digitized structural information to create/visualize structural trends.
- Use underground channel/vein sampling, surface, plan, and section interpretations to create a detailed vein model.
- Create grade shells to aid on future targeting and possible drill hole planning.

### 9.2.1 2D Compilation – ArcGIS (2019)

Downloaded and date-stamped shapefiles (SHP) that include (sources include INGEMMET):

- “Concession” fabric as of 1 June 2019.
- Gravity Bouguer points.
- Structure: folds, faults, and structural domains at 100K and 50K.
- Rock samples with geochemical data (50 elements) for 50K NTS sheet.
- Geology polygons and polylines for the NTS 26L sheet as well as the regional geology at 100K.
- Topography: includes infrastructure such as highways, roads, land use and main towns.
- Hydro: includes rivers and lakes.
- Boundaries: includes NTS sheets and administrative boundaries (Municipalities etc.).
- INGEMMET: linked for up to date/live data from the Geological Survey of Peru:
  - Geology and structures for Peru at 100K.
  - Geology at 50K scale (specific areas only).
  - Concession Fabric: a) Active Concessions; b) Concessions Requested; c) Exploration Concessions; and d) Mining Concessions.

### 9.2.2 3D Compilation – Leapfrog (2019)

The following information was integrated into a 3D model:

- Topography: ALOS, ASTER and SRTM DEM point files (at 30 m accuracy), 2 satellite images and elevation contour lines from ACOMISA.
- Concession boundary pressed to topography.
- Mineralization: Digitized vein interpretations from plans and surface.
- Interpretations: 5 Plans and 26 Cross Sections.
- Surface geology pressed to topography, as interpreted by team in Peru.
- Vein sampling represented as channel samples/drill holes.
- Polylines of faults and veins digitized from cross sections and surface interpretations.
- Structural data (joints, faults, and veins), and regional structural interpolated from 463 measurements.
- Infrastructure meshes wireframed in Datamine (main drifts only - sub-levels and raises pending wireframing).
- Geological model includes surfaces and volumes for 11 veins and 3 main faults.
- Numeric models: Preliminary Ag and Zn grade shells.

### 9.2.3 Geological Model (2019)

Following a review and compilation of all data in 2D and 3D, a geological model was created in Leapfrog, covering the area of the Santa Elena concession that includes underground workings, plan maps and interpreted sections (about 800 by 500 meters):

- The model was broken into 4 blocks on the basis of 3 main faults.
- Structural data was filtered by 3 categories - joints, faults, veins:
  - From vein data an initial form interpolant was created.
  - Fault data was used to inform fault surfaces.
- Created lithology from surface interpretation.
- Detailed vein model from digitized lines on plans, sections, and surface.
- Vein interactions and cross cutting relationships:
  - Minor veins need pinch outs (to be completed).
- Created grade shells for Ag and Zn, using isotropic unmodified trends and the structural form interpolant as a global trend.
  - Silver and zinc mineralization in vein system display plunge of ~25-30 degrees SW.

Orix suggested that the vein system corresponds to “Rosario” style veining, with a pinch and swell characteristic. However, due to the sparse underground control data, the veins were modelled as continuous surfaces, honouring the contacts measured to date.

### 9.3 Remote Sensing (2020)

In October 2020, Kuya engaged Dirt Exploration (Neil Pendock) to complete a remote sensing study of the Project and surrounding area using satellite visible/near infrared (“VNIR”), shortwave infrared (“SWIR”), and longwave infrared (“LWIR”) imagery (Pendock, 2020).

A data cube of LWIR emissivity and VNIR/SWIR reflectance was unmixed into two sets of spectral abundances, corresponding to mineralized and barren areas, in a 60 x 60 satellite scene. Mineralization was identified by comparing spectra over five known mines to the average spectral response in the scene.

Individual spectral abundances may be used to generate exploration targets, or a statistical classifier may be estimated to find targets with similar thermal response to the known mines. Satellite remote sensing supplies an inexpensive and dense data layer at high spatial resolution which may be integrated with other exploration datasets such as geochemical surveys and geophysics to generate viable exploration targets.

9.4 Phase 1 Surface Exploration (2021)

Over the course of 2021, more than 500 surface samples, including rock grab samples and trench samples, were collected from veins exposed at surface or under shallow cover, as well as mineralized or unmineralized host rock (Figure 9-1). The Company focused surface sampling primarily on two zones over the past year: the Main Zone (also referred to as the Bethania Mine Area) and the Hilltop Zone (previously the “Bethania Extension Zone”).

The work was undertaken in two phases: Phase 1 occurred in February and March of 2021, in preparation for the 2021 drilling program described below; Phase 2 surface sampling began in November 2021 and is ongoing as at the date of this AIF.

A total of 97 rock grab samples were collected from veins exposed at surface. Of the 97 rock grab samples, 76 were taken from veins and 21 were taken from altered or visibly unmineralized host rock (hanging wall or footwall to the veins). QA/QC samples were inserted in the sample stream (see Section 11).

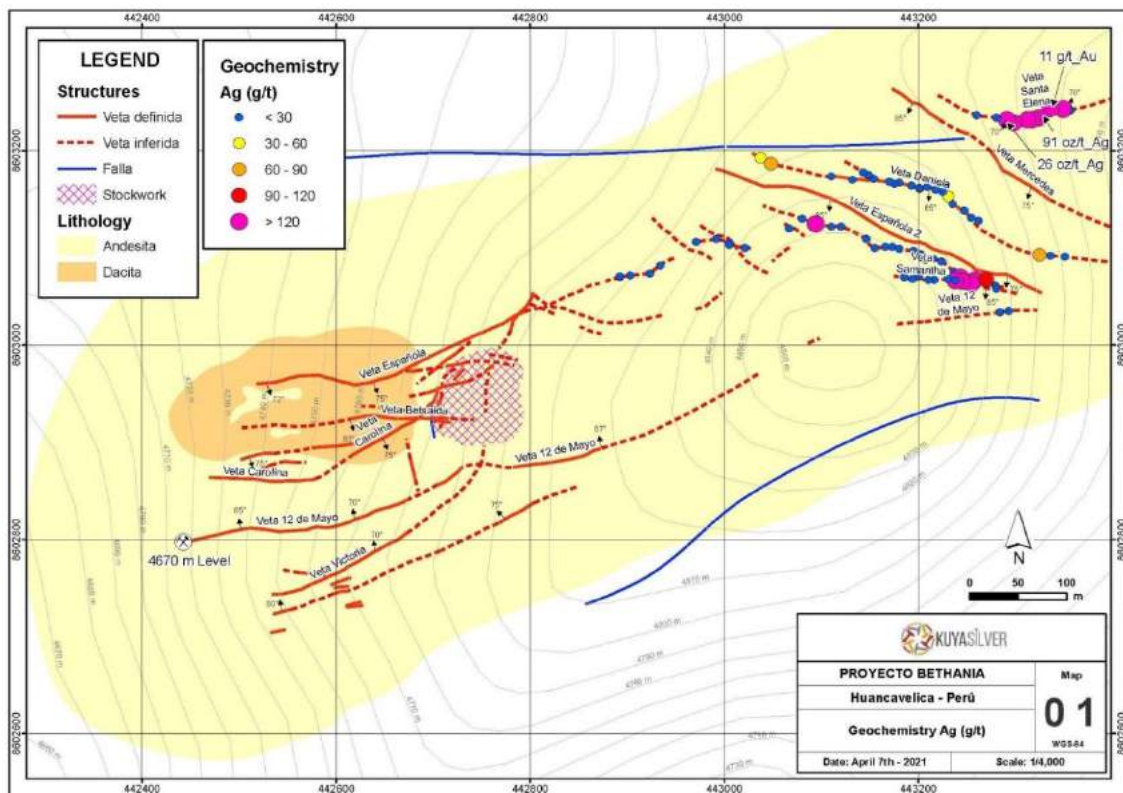

Figure 9-1: General geology and geochemistry map showing location and results of rock grab samples on the Santa Elena concession, Bethania Silver Project (source: Kuya news release dated 8 April 2021).

The sampled veins are located approximately 600 to 1,000 m from the main adit of the Bethania Mine and 100 to 500 m east of the easternmost underground development (Figure 9-1). When mineralized, the sampled veins reported anomalously high silver and lead, and in some cases anomalous gold. Anomalous zinc and copper grades, which can be associated with



silver mineralization in the fresh veins underground, were rarely observed from surface results.

#### **9.4.1 Hilltop Zone Sampling**

The easternmost area sampled to date (in Phase 1) identified a new vein at surface, named the Santa Elena vein or Veta Santa Elena, located in the northeast region of the Property, approximately 500 m along strike from the eastern limit of the Española underground workings. Rock grab samples were collected at approximately 10 m intervals along surface exposure of the vein system. Seven consecutive rock grab samples distributed over a length of 60 m, averaged 698 g/t Ag (22.4 oz/t Ag), 2.79 g/t Au and 3.07% Pb. Results from the Veta Santa Elena sampling included:

- 2833 g/t Ag (91.1 oz/t Ag), 5.20 g/t Au, 10.6% Pb
- 300 g/t Ag (9.6 oz/t Ag), 11.03 g/t Au, 2.17% Pb
- 812 g/t Ag (26.1 oz/t Ag), 0.32 g/t Au, 4.82% Pb

A second zone of interest was located at the intersection between a parallel vein structure to the Española 2 vein and the newly identified “Samantha” vein in the northeast part of the Property. At the vein intersection, four consecutive rock grab samples distributed over a length of 30 m (northwest-southeast) averaged 258 g/t Ag (8.3 oz/t Ag) and 2.84% Pb. Along the Samantha Vein, three consecutive rock grab samples distributed over a length of 20 m (west-northwest-east-southeast) averaged 171 g/t Ag (5.5 oz/t Ag) and 2.33% Pb (see the Company’s news release dated April 8, 2021).

Further sampling of the Hilltop Zone in Phase 2 work resulted in positive results from the Mercedes Vein, Española 2 Vein, and No. 24 Vein. (See the Company’s news releases dated 26 January 2022, and 16 March 2022.)

#### **9.4.2 Main Zone (Bethania Mine Area) Sampling**

Sampling occurring recently in Phase 2 in the Main Zone has resulted in the recognition of numerous new mineralized vein structures (branches and splays) associated with the previously identified vein systems, 12 de Mayo, Victoria, and Española. In addition, some samples were taken on known veins to get a better sense of the trends and orientation of the higher-grade zones within the Bethania vein system. (See the Company’s news releases dated 26 January 2022 and 16 March 2022.)

One of the most promising discoveries from this area is the newly identified Carmen Vein (and Carmen Vein branch) located on the southern flank of the Bethania property, dipping to the north and sub-parallel to the Victoria Vein. While some samples reported anomalous silver

(up to 343 g/t) it was found to be consistently mineralized by anomalous gold grades (up to 6.26 g/t) along a 300-metre strike length.

### 9.5 Geological Modelling (2021)

In early 2021, in preparation for the planned maiden mineral resource estimate and to guide planning of the Phase 1 drilling program, a geological model of the Santa Elena vein system was completed, prepared by Atticus Consulting S.A.C. and Caracle Creek International Consulting Inc.

The new geological vein system model utilised the three-dimensional interpretation created by Orix Geoscience (2019) as a base but incorporated additional drill data and surface outcrop information to the model. The additional source of spatial data highlighted a discrepancy in the location of the historic underground data, which was then updated as a new underground topographic survey became available. Only 20% of the underground workings were successfully surveyed, the rest of the mapped workings and channel samples were adjusted spatially according to the delta X, delta Y and delta Z of the surveyed areas (Figure 9-2).

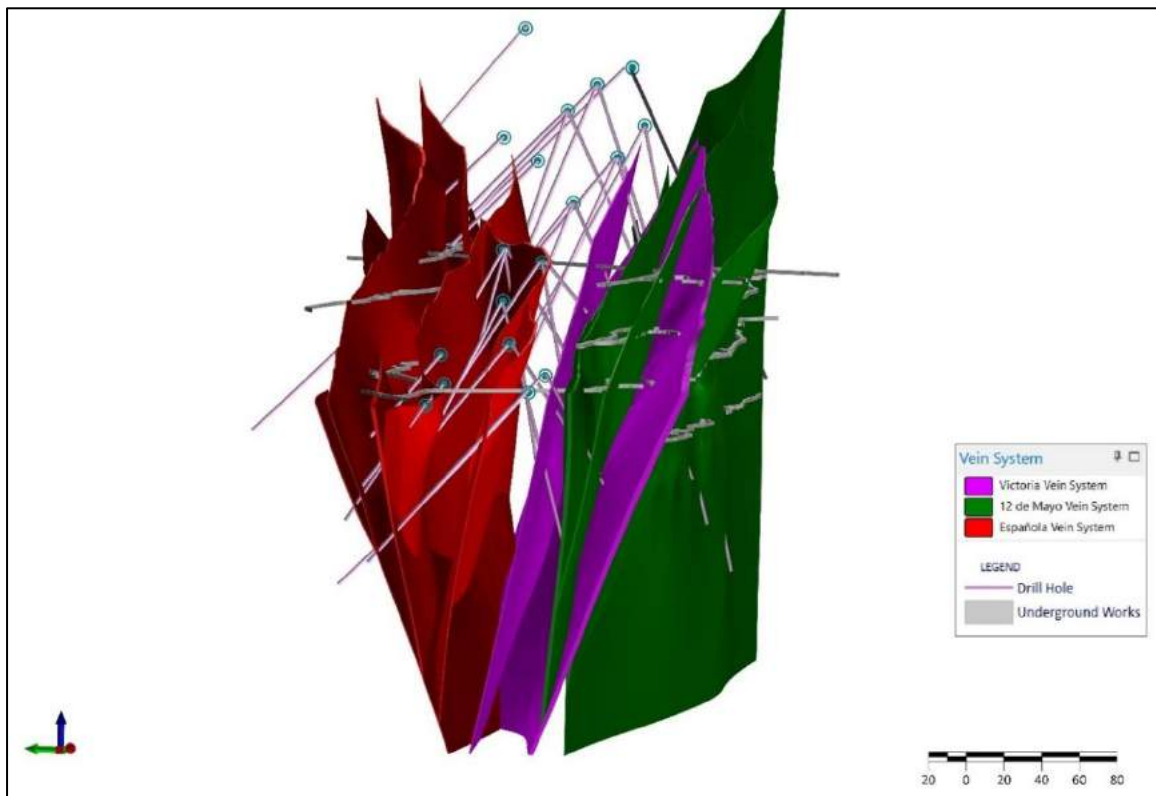

Figure 9-2: A 3D isometric view of the vein systems, looking towards the east, showing their spatial relation with the defining drilling and the underground workings

The drill data, surface outcrop information, and historic underground data were all correctly located in 3D space within the Micromine engineering software, and a new interpretation realized. The drilling data confirmed that the vein systems are “Rosario” style veins which open and close along strike; however, the veins are continuous as mineralized structures,



hence they have all been modelled from assay data rather than the logged occurrence of vein material. The material that has been identified and modelled as ‘vein’, is defined by the presence of vein style Ag-Pb-Zn mineralization. No strict cut-off has been used to define the vein material, just the observed elevation in silver, lead or zinc, with the occasional anomalous presence of copper or gold.

The new geological model defined four principal vein sets, three previously known and one newly identified principal vein, each with their sets of branches. The Española vein set comprises Española\_P (the principal), Española RFW, Betsaida, Carolina, Carolina II, Carolina RFW, Maria, Maria RHW, and Maria RHW1. The 12 de Mayo vein set comprises 12 de Mayo\_P (the principal), 12 de Mayo RFW, 12 de Mayo RFW1, and 12 de Mayo RHW. The Victoria vein set contains the Yolanda and Victoria (principal) veins. The newly identified principal vein set includes the provisionally named NV\_P (New Vein principal) and its associated branch, NV\_RFW (Figure 9-3).



Faults are seen to run along the footwall of the main vein sets Española, Victoria and 12 de Mayo, but displacement could only be interpreted, measured, and modelled on the Victoria vein. The main fault that was previously interpreted, could not be identified in the drilling nor was any displacement observed either side of its supposed location. Three fault blocks have been modelled, using the Victoria footwall fault and the Rocio fault have been modelled, generating the Mine Zone, South Zone and Hilltop Zone fault blocks. The location of the Rocio fault is still not yet determined, it has been included in this phase of modelling as the division between the Hilltop Zone and the Mine Zone. A cross-section view of the vein systems and mineralized structures at Bethania Mine, Santa Elena concession is provided in Figure 9-4.

Lithology, alteration, and rock mechanic models have also been constructed using only the drilling data but will require updating when information can be extracted from underground mapping. The process of geological modelling is ongoing.

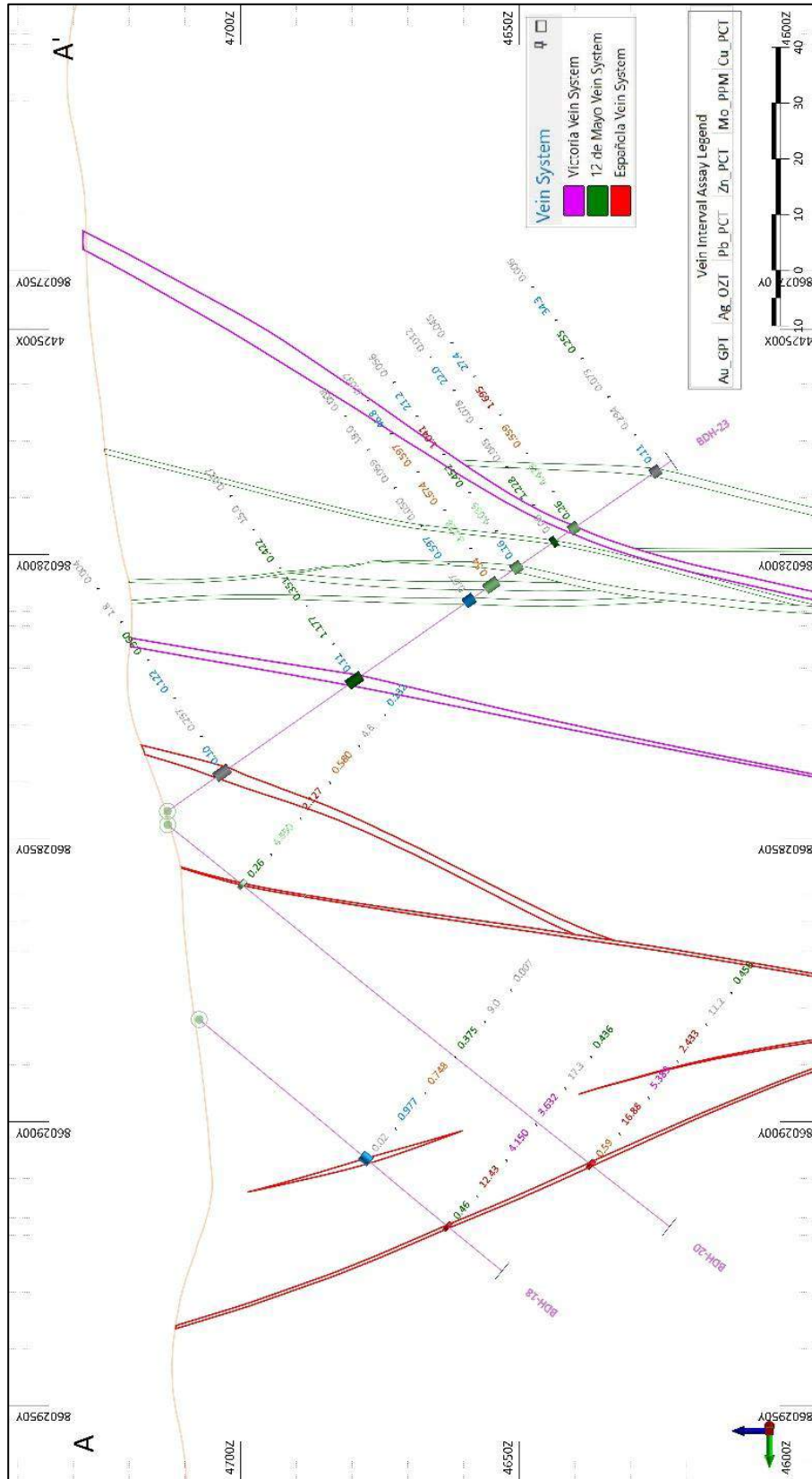

Figure 9-4: Section view, looking towards the east, showing the vein systems (vein sets) and the drilling intervals that define the mineralized structures

## 9.6 Phase 2 Surface Exploration (2021)

On 15 November 2021, Kuya announced that it had commenced its second phase of its 2021 exploration program focusing mainly on detailed surface sampling and trenching accompanied by detailed mapping and sampling.

The main goals of the Phase 2 exploration program are to (Kuya news release dated 15 November 2021):

- Expand the resource base at the Bethania Project by extending known mineralization (i.e., veins) along strike and at depth.
- Gain a better understanding of the controls on mineralization in newly identified mineralized zones such as the Hilltop Zone and the nearby Carmelita concession for potential future resource growth.
- Prospect additional concessions in the Bethania district exploring for additional near-surface mineralized vein targets.

The planned 7,000 m trenching program will be aimed at the Hilltop Zone and main Bethania Mine area (Figure 9-5). The trenching program has been designed to gather more data on the host rock and veins that outcrop on surface to determine strike length, width of mineralization, grade variation in veins, variation in geometry, and other important features such as branching or intersecting vein systems.

In December 2021, Kuya announced that it would be expanding its Phase 2 surface exploration program to cover additional targets located within newly acquired mining concessions (Kuya news release dated 1 December 2021). Mineralized veins previously discovered at the Hilltop Zone (located northeast of the Bethania mine area), such as the Española 2 and Mercedes veins (Figure 9-5), strike northwest-southeast and appear to continue onto the newly acquired claims.

Kuya also noted that several mineral showings, identified by Peruvian government geologists north of the Santa Elena concession, are proximal to, and are along trend of, known areas of mineralization at Bethania (Figure 9-6). For example, the Capri 98 showing is described by INGEMMET (2003) as being a mineralized, 0.6 m wide, east-west-trending structure, which is similar to the principal veins in the main Bethania system such as 12 de Mayo and Española. INGEMMET (2003), reports an outcrop rock grab sample that assayed 702 g/t Ag, 1.17 g/t Au, 10.2% Pb, 2.6% Zn, and 0.4% Cu. The INGEMMET (2003) report does not contain a description of the type of analytical or testing procedures utilized, the sample size, or the name and location of any laboratory used.

As of the Effective Date of the Report there is no additional information, data, or results regarding the Phase 2 surface exploration program.



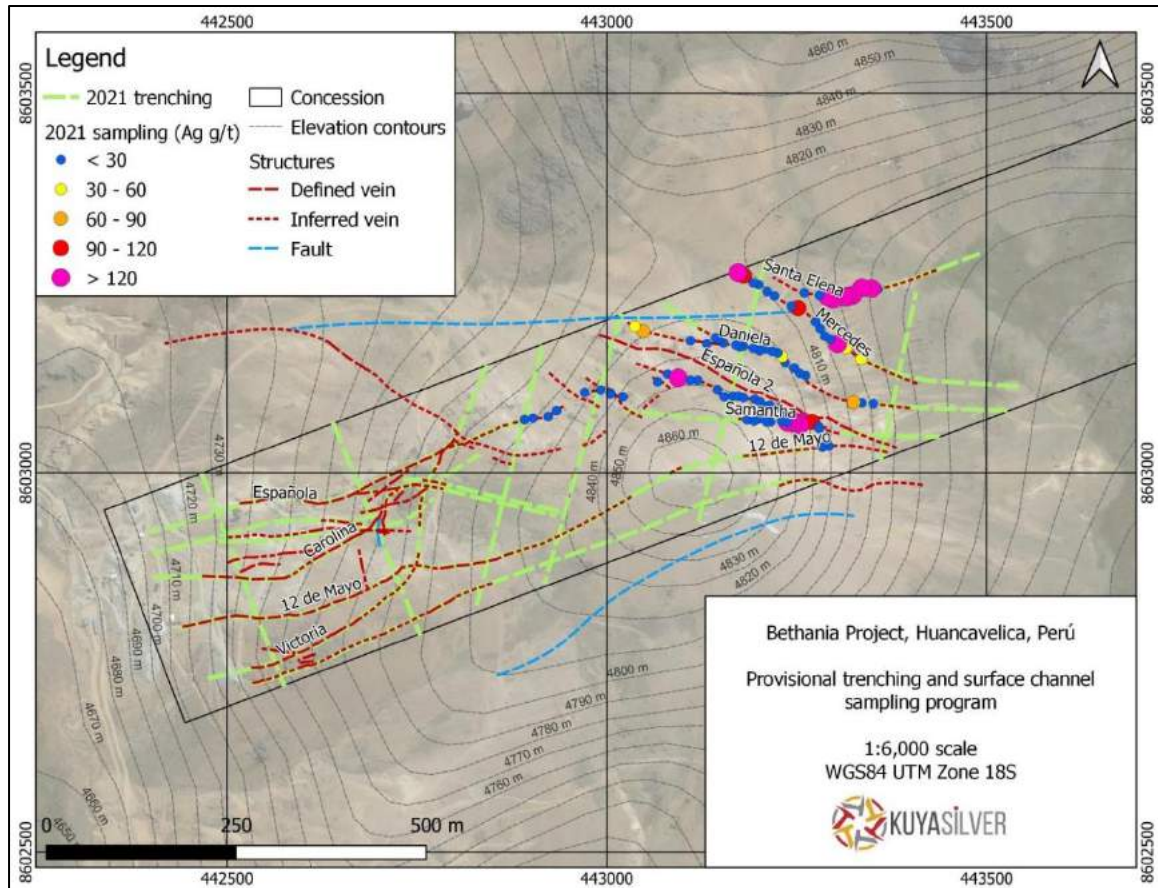

Figure 9-5: Bethania property map showing the multitude of main silver- and gold-bearing veins mapped at surface and the planned trenching and surface sampling for the Phase 2 surface program (Kuya news release dated 15 November 2021). The Hilltop Zone is located

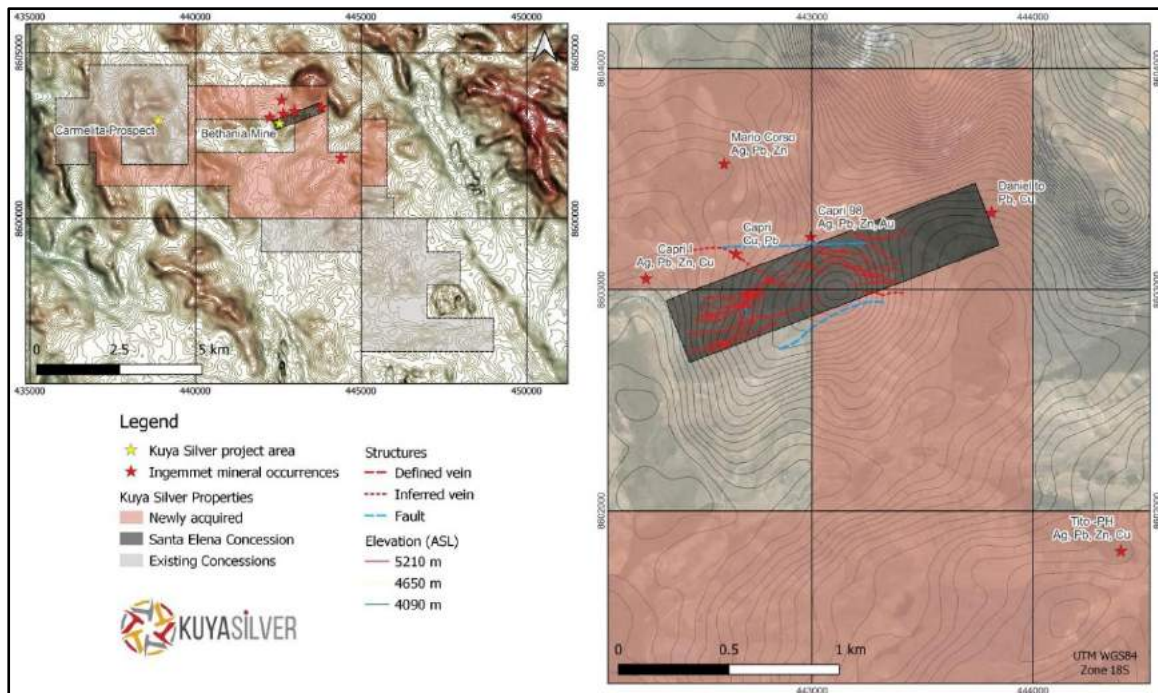

Figure 9-6: Property maps: (left) location of the main Santa Elena concession within the area of recently acquired concessions and INGEMMET (2003) reported mineral occurrences and (right) close up of the Santa Elena concession and mineral occurrences reported by INGEMMET (2003) (Kuya Silver, 2021).

## 9.7 Exploration Potential – Bethania Silver Mine

At the Bethania Mine (Santa Elena concession), much can be gained by drilling along the well-known east-northeast trending and lesser explored northwest-trending mineralized structures to determine strike and depth continuity, from surface and/or from underground. In most cases, this should involve relatively low risk drilling to increase the known mineralized vein system along strike and at depth and provide a better understanding of the mineralization style on the Property.

Historically, production has focused on the vein systems around the Bethania Mine (previously Mina Santa Elena), no systematic studies have been conducted to identify and characterize the disseminated sulphide mineralization observed in the host rocks (i.e., altered andesite-dacite and stockwork siliceous breccias) located between the vein sets.

### 9.7.1 Strike Length Extension

Mining has occurred (and internal reserves calculated) on six veins, including the major Española and 12 de Mayo structures and the minor or cross-cutting Victoria, Carolina, Maria, Ramal 12 de Mayo, and Española 2 veins. The major structures have been explored from west to east, starting near the main adit at the western edge of the Property. Both structures have been developed for approximately 500 meters. Both the Española and 12 de Mayo veins have the potential to be delineated along the 1.5 km east-northeast to west-southwest length of the Property, which could significantly increase the potential for additional mineralization. The minor structures, with the exception of Española 2 vein, were discovered subparallel to the major structures through regular mining development of the two major veins. In these cases, there is still significant strike length (200 to 300+ m) between the two major veins available for future exploration.

### 9.7.2 Depth Extension

Through mining at various levels over the past 40 years, the vertical continuity of both the major and minor veins appears to be very strong – all seven of the developed veins remain open at depth. While some pinching and swelling of veins is to be expected, minerals have been mined (or historical reserves developed) in the largest vein, 12 de Mayo, from the 4790 level down to the 4640 level, a depth of 150 meters. The vein at the bottom 4640 level still appears to be consistent with typical historical Bethania Mine production mineral grades and thicknesses, suggesting further depth potential. Stein (2018) notes a similar vertical extension in the Española, Maria, Carolina, Ramal 12 de May, and Victoria veins. At the Española 2 vein, located further east than the other six veins, mineralization has been identified at surface around the 4940 m elevation, with mining development at the 4830 level, and like the western veins, mineralization remains open at depth.



### 9.7.3 *New Surface Vein Discoveries*

Surface exploration work by Kuya in 2021 at the Hilltop Zone reported the discovery of several new veins, along with results from surface sampling (see news release dated 8 April 2021). The new surface exposed west-northwest trending vein systems.

- Santa Elena - ~500 m along strike of easternmost historical Española 2 workings.
- Mercedes – sub-parallel and south of the northernmost Española 2 vein.
- Samantha - sub-parallel and south of the Española 2 vein.
- Daniel - between the Mercedes Vein to the north and the Española 2 vein to the south.

These sampled surface veins are located approximately 600 m to 1,000 m from the main Bethania adit to the southwest and 100 to 500 m east of the easternmost historical underground development. When mineralized, the vein zones sampled reported anomalously high silver and lead, and in some cases anomalous gold.

## 9.8 Exploration Potential – Other Concessions

### 9.8.1 *Chinita I Concession*

The Chinita I concession, located about 5.5 km east of the Santa Elena concession, covers a regional north-south oriented unconformity (fault) between older Cretaceous sedimentary (limestone) rocks in the east and Tertiary volcanic (andesite) and sedimentary (sandstone) rocks to the west. S&L identified several large (multi-kilometre) structures and alteration, however the Chinita property is at a very early stage and remains a lower priority target as Kuya looks to acquire properties closer to the Bethania Mine.

### 9.8.2 *Carmelitas Concessions*

The recently acquired Carmelita 2005, Carmelita 2005 I, and Carmelita 2005 II concessions (together “Carmelitas”), located about 4 km west of the Santa Elena concession, cover the historic Carmelita Silver Mine and the historical mining area located at Viscastina Hill (438914mE, 8602749mN; 4837 m AMSL).

Given the lithological, structural, mineralogical and alteration characteristics of the veins in the Carmelita mine, it has been classified as hydrothermal origin, low sulphidation epithermal volcanic. The silver, lead, zinc, and gold mineralized vein systems are hosted within a tectonic anticline. In detail, mineralization occurs as fracture filling with a banded texture, with minerals of argentite, galena and yellow sphalerite, and lesser fine pyrite, porous silica, rhodonite, manganese oxide, and limonite. Elevated gold concentrations are associated with high percentages of pyrite (Milla, 2016b).

### ***9.8.3 Tres Banderas 01 through 07 Concessions and Claims***

The Tres Banderas 01 through Tres Banderas 07, surround parts of the Santa Elena concession and extend approximately 5 km to the west, and 7 km southeast are underlain by Tertiary andesite, tuff, and tuff breccia cut by localized north-northeast-trending structures. These are early-stage properties but hold potential for surface and/or near-surface epithermal vein systems associated with a deeper porphyry system.

## 10 DRILLING

On 18 March 2021, Kuya announced that it had commenced a Phase 1 drilling program (began 16 March 2021) at the Bethania Silver Project, with the plan to drill 5,000 meters in 36 holes. The Phase 1 drilling program began on 16 March 2021 (drill hole BDH-01 on platform PLAT-17) and finished on 26 May 2021 (drill hole BDH-36 on platform PLAT-19), totalling 4,988.05 meters in 36 drill holes (Figure 10-1; Table 10-1).

Table 10-1: Summary of Phase 1 diamond drilling program completed in March to May 2021

BHID	Platform	Dip	Az	UTMX	UTMY	Elev (m)	Length (m)	Start (dd/mm/yyyy)	End (dd/mm/yyyy)
BDH-01	PLAT-17	-45	218	443341.64	8603114.95	4793.60	210.40	27/03/2021	02/04/2021
BDH-02	PLAT-11	-67.5	340	442889.42	8602956.99	4820.55	205.20	04/04/2021	09/04/2021
BDH-03	PLAT-10	-72	340	442838.33	8602953.67	4810.00	195.70	05/04/2021	09/04/2021
BDH-04	PLAT-11	-46	342	442889.34	8602957.14	4820.55	135.00	09/04/2021	11/04/2021
BDH-05	PLAT-10	-45	340	442838.08	8602954.34	4810.00	110.20	10/04/2021	11/04/2021
BDH-06	PLAT-10	-64	160	442838.33	8602953.69	4810.00	206.30	12/04/2021	17/04/2021
BDH-07	PLAT-11	-71	160	442889.48	8602956.83	4820.55	216.60	12/04/2021	16/04/2021
BDH-08	PLAT-15	-45	340	442742.47	8602932.96	4790.45	75.50	17/04/2021	17/04/2021
BDH-09	PLAT-09	-62	340	442805.69	8602897.02	4806.40	195.20	17/04/2021	20/04/2021
BDH-10	PLAT-08	-51	345	442749.01	8602891.36	4793.40	124.65	18/04/2021	20/04/2021
BDH-11	PLAT-08	-66	345	442749.32	8602890.23	4793.40	170.60	21/04/2021	22/04/2021
BDH-12	PLAT-09	-78	160	442805.66	8602897.11	4806.40	240.95	21/04/2021	24/04/2021
BDH-13	PLAT-09	-75	160	442749.62	8602890.19	4793.40	200.45	23/04/2021	25/04/2021
BDH-14	PLAT-02	-49	354	442443.94	8602811.87	4701.22	160.40	25/04/2021	27/04/2021
BDH-15	PLAT-12	-54	320	442402.38	8602862.38	4686.22	75.50	26/04/2021	27/04/2021
BDH-16	PLAT-13	-51	336	442434.36	8602865.06	4694.63	75.15	28/04/2021	28/04/2021
BDH-17	PLAT-02	-62	170	442443.79	8602810.03	4701.74	60.40	28/04/2021	28/04/2021
BDH-18	PLAT-14	-50	345	442472.90	8602881.24	4707.45	70.75	29/04/2021	29/04/2021
BDH-19	PLAT-01	-47	338	442414.70	8602808.61	4695.36	125.40	29/04/2021	02/05/2021
BDH-20	PLAT-21	-53	350	442483.89	8602847.76	4713.13	115.50	30/04/2021	04/05/2021
BDH-21	PLAT-22	-62	350	442537.33	8602872.22	4731.38	120.00	02/05/2021	04/05/2021
BDH-22	PLAT-22	-74	170	442537.32	8602872.06	4731.43	130.20	03/05/2021	06/05/2021
BDH-23	PLAT-21	-55	170	442484.24	8602845.36	4713.16	110.20	05/05/2021	06/05/2021
BDH-24	PLAT-24	-75	350	442627.10	8602905.23	4752.80	130.30	07/05/2021	09/05/2021
BDH-25	PLAT-25	-66	170	442687.89	8602890.93	4773.80	160.20	07/05/2021	11/05/2021
BDH-26	PLAT-24	-60	350	442626.97	8602906.02	4752.77	60.00	10/05/2021	11/05/2021
BDH-27	PLAT-24	-80	170	442627.78	8602906.88	4752.90	133.40	11/05/2021	13/05/2021
BDH-28	PLAT-25	-69	350	442687.93	8602890.97	4773.70	155.40	12/05/2021	16/05/2021
BDH-29	PLAT-24	-58	170	442627.96	8602905.82	4752.85	175.50	13/05/2021	15/05/2021
BDH-30	PLAT-23	-79	170	442589.92	8602870.25	4749.34	110.10	16/05/2021	17/05/2021
BDH-31	PLAT-25	-53	350	442687.65	8602891.95	4773.65	105.30	17/05/2021	20/05/2021
BDH-32	PLAT-23	-50	160	442591.03	8602868.78	4749.36	35.20	19/05/2021	19/05/2021
BDH-33	PLAT-25	-56	350	442589.55	8602871.38	4749.43	130.30	19/05/2021	20/05/2021
BDH-34	PLAT-26	-45	340	442782.87	8602968.32	4799.50	90.10	21/05/2021	23/05/2021
BDH-35	PLAT-17	-45	352	443339.75	8603117.23	4793.63	280.70	21/05/2021	27/05/2021
BDH-36	PLAT-19	-45	14	443272.61	8603147.03	4819.44	91.30	25/05/2021	26/05/2021



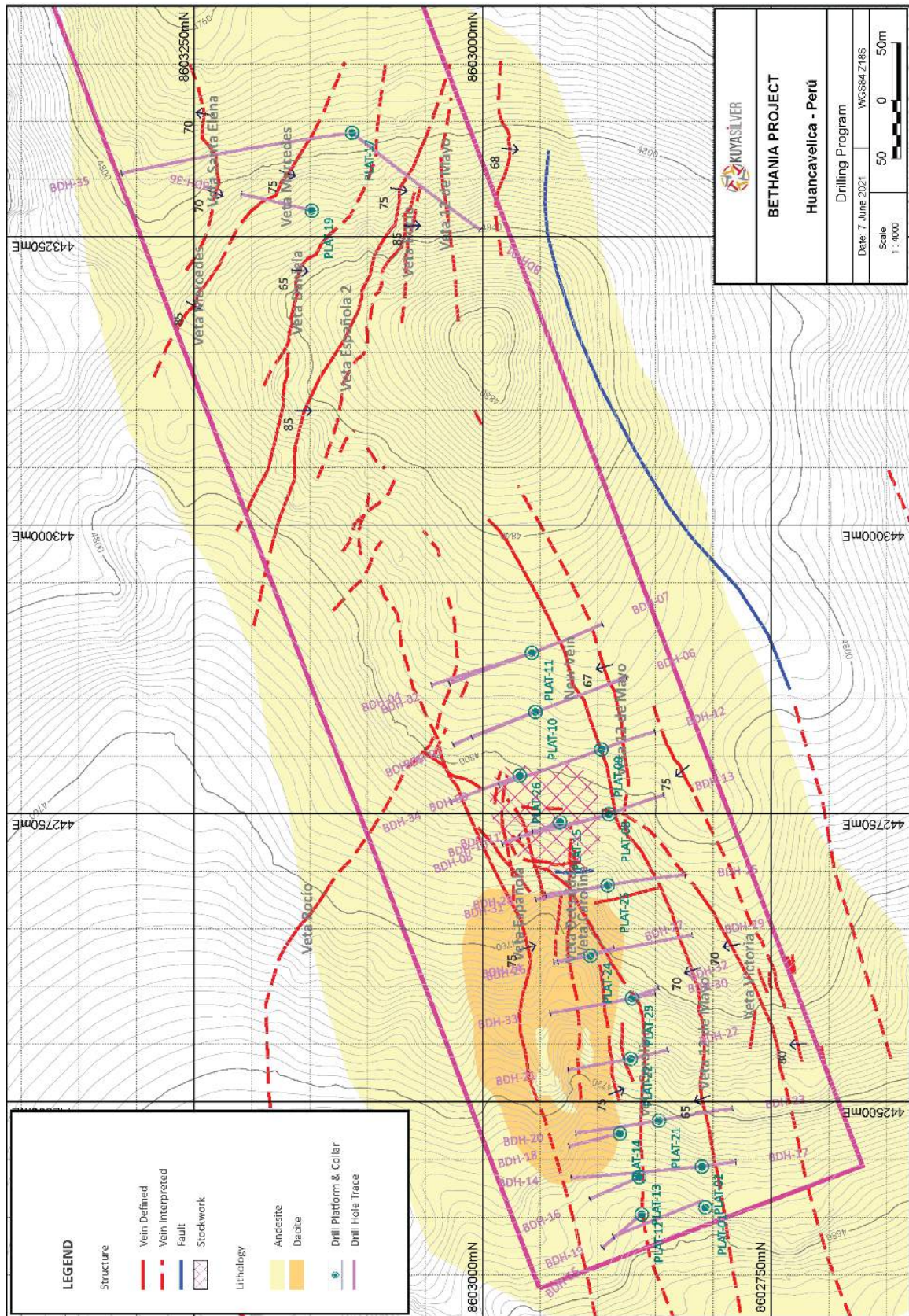

Figure 10-1: Location of drill hole collars and traces from the Phase 1 drilling program, overlain on the general geology of the Santa Elena concession, Bethania Silver Project (source: Kuya Silver, 2021).

The Phase 1 drilling program was split into two parts, with approximately 4,406.05 m aimed at the western third of the Property (Bethania Mine area), testing the seven main veins that make up historical mineral resources and were the target of previous mining activities. The assays and geotechnical measurements taken from this portion of the drilling program have been used to update the 3D geological model to support the future initial mineral resource estimate, which in turn may be used to develop a mine production plan.

The remaining 582 m targeted the Española 2 area, east-northeastern portion of the Property (Hilltop Zone), in this initial phase to confirm the extent of historical mining from the Española 2 adit, as well as testing other newly identified veins at surface. This series of drill holes are located approximately 900 m east of the main Bethania mine adit.

Drill core samples began to be submitted to the SGS laboratory in Lima, Peru as of 20 April 2021. The analyses were carried out using code FA313 - Fire Assay for gold; code ICP40B - ICP-AES Multi-acid digestion for 36 elements; and code AAS41B - Atomic Absorption, multi-acid digestion for Ag, Pb, Zn over upper detection limits. The upper detection limit on the multi-acid digestion assays for lead of 20% was reached in a few instances. SGS Laboratories in Lima has international certifications OHSAS 18001, ISO 14001 and ISO 9001 and is accredited by INACAL under the NTP-ISO / IEC 17025.

Logging and sampling procedures and the details of the QA/QC sampling program for the 2021 drilling program are provided in Section 11.

### **10.1 Diamond Drilling Procedures**

The drilling program began on 16 March 2021 with one drill rig, with an additional drill rig incorporated into the program on 1 April 2021 (Figure 10-2). Drilling took place in two shifts and ran 24 hours per day, seven days per week. Drilling was contracted to Ingeomin S.A.C. (Lima, Peru) with all core drilled in HQ3 (61.1 mm diameter). On completion of each hole, the casing was removed, the hole opening cemented closed, and the location covered with a cement marker (Figure 10-3).





Figure 10-2: Diamond drilling at platform number PLAT-017 and drill hole BDH-35 (source: Simon Mortimer, 2021).



Figure 10-3: Example of cement marker/hole cover with drill hole information placed at each of the drill hole collar locations (source: Kuya Silver, 2021).

**10.1.1 Drill Hole Setup**

The Kuya exploration team set up the drill platforms in advance according to the plan submitted within the environmental impact assessment. It was the responsibility of the drilling contractors with the support of the Kuya surveyor to locate the drill collar and align the rig according to the drill plan provided to them by the Kuya exploration team.

The Kuya surveyor assisted the drilling contractors using a LEICA TS02 Power 5 Series Total Station to locate the drill hole collar and orientate the hole. The location of the drill hole collar was surveyed again after the completion of the hole.

**10.1.2 Downhole Surveys and Core Orientation**

The drilling contractor Ingeomin was responsible for recording the downhole survey, using a DeviGyro™ multishot surveying tool manufactured by Devico (Figure 10-4), they took downhole deviation measurements approximately every five to twenty-five meters. Measurements were taken with runs down and back up the drill barrel with the average of both runs being used. The survey data extracted from the DeviGyro™ tool was imported directly into the drilling database.

The drilling contractors were also responsible for recording the core orientation, using the Devico core orientation tools they were able to align the top and bottom of the core within the core box (Figure 10-5).



Figure 10-4: Devico downhole DeviGyro™ multishot survey equipment (source: Simon Mortimer, 2021).





Figure 10-5: Orientated drill core measured using the Devico orientation tools, recorded by the drilling contractors, Ingeomin (source: Simon Mortimer, 2021).

## 10.2 Drill Core Assay Results

On 26 July 2021, Kuya released drill core assay results from the Phase 1 diamond drilling program (Table 10-2 and Table 10-3). The drilling program indicated that silver mineralization is present in the unmined extensions of known veins within the Bethania Mine, both along strike and at depth, as well as identifying new targets within the east-northeast trending vein system. A plan view map of drill hole traces and intersections of existing and newly discovered veins at Bethania is provided in Figure 10-1.

Kuya drilled three of the 36 holes (582 m) into the Hilltop Zone, which is a new target area to the east of the Bethania mine where Kuya has previous identified mineralized vein samples at surface (see Kuya news release dated 8 April 2021). This drilling is interpreted to have intersected the Mercedes Vein in BDH-36, and the Española 2 Vein and Daniela Vein at depth in BDH-01 (Table 10-3).

Table 10-2: Summary of drill core assay results, Phase 1 diamond drilling at Bethania Mine area (AgEq\*)

Hole ID	From (m)	To (m)	Interval (m)	Est. True Width (m)**	Ag (g/t)	Au (g/t)	Cu (%)	Pb (%)	Zn (%)	AgEq* (g/t)	AgEq* (g*m)
BDH-03	164.55	166.20	1.65	0.81	44.95	1.97	0.0	0.01	0.0	183.38	302.58
incl.	164.55	165.30	0.75	0.37	70.10	3.45	0.0	0.01	0.0	308.90	231.67
BDH-03	191.45	192.95	1.50	0.72	192.44	0.72	0.0	0.48	0.6	279.70	419.56
incl.	192.75	192.95	0.20	0.10	1325.00	2.51	0.2	3.10	3.0	1702.58	340.52
BDH-10	123.22	124.65	1.43	1.23	749.00	0.63	0.4	2.58	2.5	987.12	1411.58
BDH-13	51.90	52.80	0.90	0.59	84.76	0.74	0.0	0.62	3.6	279.64	251.68
BDH-13	182.14	185.10	2.96	1.09	98.10	0.23	0.0	0.43	0.9	157.51	466.24
incl.	184.17	185.10	0.93	0.34	171.00	0.35	0.0	0.58	0.8	239.65	222.87
BDH-15	33.95	37.55	3.60	2.95	35.12	0.15	0.0	0.80	0.7	90.67	326.42
incl.	33.95	34.15	0.20	0.16	338.00	1.54	0.1	8.17	7.6	928.53	185.71
BDH-15	56.55	57.70	1.15	0.83	203.02	0.14	0.1	2.59	5.2	472.29	543.14
incl.	56.80	57.30	0.50	0.36	394.00	0.16	0.3	4.53	9.8	889.11	444.55
BDH-15	64.35	65.40	1.05	0.87	257.62	0.18	0.4	1.81	1.6	414.93	435.68
incl.	64.55	65.00	0.45	0.37	580.00	0.32	0.9	3.88	3.2	908.34	408.75
BDH-16	27.90	29.15	1.25	0.69	267.24	0.14	0.1	3.68	1.8	444.49	555.61
incl.	27.90	28.10	0.20	0.11	1613.00	0.27	0.4	20.00	7.5	2464.45	492.89
BDH-17	42.90	45.50	2.60	1.60	751.88	0.31	0.2	5.24	1.9	994.71	2586.24
incl.	42.90	43.30	0.40	0.25	3994.00	0.86	0.9	20.00	8.5	4972.62	1989.05
BDH-17	58.50	60.40	1.90	unk.	99.86	0.20	0.0	1.07	0.7	170.17	323.33
incl.	59.00	59.45	0.45	unk.	315.00	0.26	0.1	2.39	1.5	453.59	204.11
BDH-18	57.75	58.50	0.75	0.67	385.67	0.46	0.4	4.15	3.6	699.21	524.40
BDH-19	101.50	102.15	0.65	0.39	397.00	0.21	0.1	10.87	3.2	820.67	533.43
BDH-20	97.05	97.90	0.85	0.75	523.61	0.60	0.5	5.39	2.4	839.89	713.90
incl.	97.05	97.50	0.45	0.40	927.00	1.01	0.8	10.05	4.3	1498.98	674.54
BDH-21	81.00	83.85	2.85	1.65	207.12	0.07	0.0	0.72	0.1	236.36	673.64
incl.	83.00	83.85	0.85	0.49	438.00	0.10	0.0	2.35	0.1	515.83	438.45
BDH-23	69.60	72.33	2.73	unk.	97.02	0.55	0.0	0.67	0.6	176.51	481.88
incl.	70.74	71.10	0.36	unk.	374.00	2.50	0.1	0.55	1.6	624.21	224.71
BDH-23	76.50	77.40	0.90	0.61	241.93	0.20	0.1	0.88	2.0	356.96	321.27
incl.	77.10	77.40	0.30	0.20	612.00	0.27	0.3	2.23	5.6	911.52	273.46
BDH-23	88.10	89.85	1.75	1.46	138.71	0.26	0.1	0.56	1.7	234.23	409.90
BDH-24	106.35	107.55	1.20	0.63	765.48	0.64	0.2	8.88	1.7	1127.21	1352.65

Hole ID	From (m)	To (m)	Interval (m)	Est. True Width (m)**	Ag (g/t)	Au (g/t)	Cu (%)	Pb (%)	Zn (%)	AgEq* (g/t)	AgEq* (g*m)
incl.	106.35	106.80	0.45	0.24	1818.00	0.86	0.5	20.00	3.3	2573.94	1158.27
BDH-25	38.00	40.90	2.90	2.10	4.51	1.10	0.1	0.00	0.0	86.66	251.31
BDH-25	60.85	62.40	1.55	1.17	155.91	0.63	0.2	2.32	2.0	349.77	542.15
incl.	61.30	61.90	0.60	0.45	359.00	1.10	0.4	5.35	4.1	763.99	458.40
BDH-27	126.50	130.15	3.65	2.34	179.63	0.18	0.1	1.11	0.4	248.04	905.33
incl.	129.20	130.15	0.95	0.61	640.63	0.31	0.4	2.37	1.0	803.16	763.00
BDH-28	118.52	120.85	2.33	1.12	253.17	1.12	0.1	1.57	0.9	412.08	960.14
incl.	119.40	120.85	1.45	0.70	373.00	1.41	0.1	2.10	1.1	578.06	838.19
BDH-28	123.80	125.15	1.35	0.81	109.61	0.54	0.0	0.66	1.0	201.71	272.30
incl.	124.95	125.15	0.20	0.12	710.00	3.20	0.1	4.36	6.6	1282.33	256.47
BDH-29	87.95	89.40	1.45	1.18	332.77	1.73	0.6	3.29	2.1	673.00	975.84
incl.	88.38	88.70	0.32	0.26	1209.00	6.33	1.8	9.51	5.0	2257.41	722.37
BDH-30	95.90	97.40	1.50	0.90	225.08	1.24	0.7	1.32	1.5	471.58	707.37
BDH-31	93.20	95.20	2.00	1.60	238.00	1.55	0.6	1.24	1.3	481.90	963.81
BDH-33	0.00	2.00	2.00	unk.	81.80	0.12	0.0	1.96	0.1	151.00	302.00
BDH-33	122.55	129.27	6.72	5.51	121.22	0.38	0.1	1.98	0.5	222.56	1495.61
incl.	128.25	128.70	0.45	0.37	696.00	0.76	0.0	20.00	0.7	1304.30	586.94
BDH-34	42.40	46.00	3.60	2.92	37.31	0.56	0.1	0.66	0.2	108.88	391.98
BDH-34	52.00	54.00	2.00	unk.	4.80	1.69	0.1	0.03	0.1	141.24	282.49

\*AgEq calculated using US\$26.20 Ag/oz; US\$1782.30 Au/oz; US\$9,368 Cu/tonne; US\$2,217.95 Pb/tonne; US\$2,879.17 Zn/tonne;

\*\*estimated true width based on visual estimates made from drill hole cross sections; unk = unknown

Table 10-3: Summary of dill core assay results, Phase 1 diamond drilling at the Hilltop Zone

Hole ID	From (m)	To (m)	Interval (m)**	Ag (g/t)	Au (g/t)	Cu (%)	Pb (%)	Zn (%)	AgEq* (g/t)	AgEq* (g*m)
BDH-01	50.70	52.30	1.60	11.2	0.12	0.09	0.16	0.06	36.00	57.60
incl.	52.05	52.30	0.25	56.3	0.64	0.52	0.81	0.15	183.29	45.82
BDH-01	75.30	76.45	1.15	13.7	0.00	0.01	0.76	0.05	36.52	41.99
incl.	76.25	76.45	0.20	76.3	0.02	0.03	4.30	0.25	203.20	40.64
BDH-36	54.20	57.70	3.50	62.3	0.01	0.01	0.01	0.02	64.93	227.25
incl.	57.15	57.70	0.55	251.0	0.01	0.02	0.04	0.05	256.54	141.10

\*AgEq calculated using US\$26.20 Ag/oz; US\$1782.30 Au/oz; US\$9,368 Cu/tonne; US\$2,217.95 Pb/tonne; US\$2,879.17 Zn/tonne;

\*\*true widths are not known, and drill core intervals are being treated as core lengths.

## 11 SAMPLE PREPARATION, ANALYSES AND SECURITY

To the extent that it is available, information regarding the sample preparation, analyses, and security for historical work performed on the Property is provided in Section 6. Information in this section applies to current work completed by Kuya on the Santa Elena mining concession.

It is the Authors' opinion that the Issuer followed acceptable standards and protocols in the collection, sample preparation, analysis and security of the information and data collected during their exploration work that is the subject of the Report. Furthermore, the sample preparation, security and analytical procedures followed are adequate to support the reliability of the data and information presented herein.

### 11.1 Certified Reference Material

For Kuya's QA/QC programs, the Certified Reference Material ("CRM") used in all of Kuya's 2021 exploration programs (i.e., surface sampling and drilling) is summarized in Table 11-1, Table 11-2, and Table 11-3. The three different CRMs used were supplied by Smee & Associates Consulting Ltd. North Vancouver, BC, Canada. These CRMs were chosen on the basis of their range of gold, silver, copper, lead, zinc, and iron concentrations, and because they were extracted from an epithermal deposit similar in nature to the deposit being drilled.

*Table 11-1: Summary of Certified Reference Material PLSUL29 used in the Kuya QA/QC program*

Element	Certified Mean	2 Std Dev (between lab)
FA Au	0.525 g/t	0.030 g/t
AR Ag	40.8 ppm	2.9 ppm
AR Cu	550 ppm	40 ppm
AR Pb	1.15%	0.06%
AR Zn	1.52%	0.06%
AR Fe	3.44%	0.24%

*Table 11-2: Summary of Certified Reference Material PLSUL30 used in the Kuya QA/QC program*

Element	Certified Mean	2 Std Dev (between lab)
FA Au	0.438 g/t	0.022 g/t
AR Ag	185 ppm	7.0 ppm
AR Cu	1861 ppm	71.0 ppm
AR Pb	4.17%	0.20%
AR Zn	6.63%	0.22%
AR Fe	4.80%	0.54%

Table 11-3: Summary of Certified Reference Material PLAUL31 used in the Kuya QA/QC program

Element	Certified Mean	2 Std Dev (between lab)
FA Au	0.164 g/t	0.012 g/t
AR Ag	93 ppm	4.0 ppm
AR Cu	0.095%	0.008%
AR Pb	2.02%	0.05%
AR Zn	3.28%	0.20%
AR Fe	2.47%	0.21%

Means and standard deviations were calculated from data supplied by six laboratories, each performing 10 analyses on randomly selected samples. Gold was analyzed using Fire Assay and ICP or AAS finish, and base metals were analyzed using an aqua regia digestion and ICP or AAS finish.

The participating laboratories were:

- ALS, Lima
- SGS, Lima
- Certimin, Lima
- Inspectorate, Lima
- Actlabs, Lima
- BV, Vancouver.

The final limits were calculated after first determining if all data was compatible within a spread normally expected for similar analytical methods done by reputable laboratories. Data from any one laboratory was removed from further calculations when the mean of all analyses from that laboratory failed a test of the global means of the other laboratories. The means and standard deviations were calculated using all remaining data. Any analysis that fell outside of the mean  $\pm 2$  standard deviations was removed from the ensuing data base.

It should be noted that the exploration program assays (i.e., surface sampling and drill core) were analyzed using 4-acid “Near Total” Digestion whereas the standards were certified using aqua regia digestion.

#### 11.1.1 Blank Material

The blank reference material was provided by Target Rocks of Lima, sourcing both fine- and coarse-grained reference material from certified sterile rocks. The fine-grained material was

used to monitor for contamination in the assaying procedures whereas the coarse-grained material was used to monitor for contamination in both the sample preparation and assaying procedures at the laboratory.

## **11.2 Surface Vein Sampling (2021)**

In February-March 2021, the Company completed surface sampling on several known and newly discovered veins at Bethania, releasing the results on 8 April 2021. Samples were collected as rock grab samples (rock chip samples) along the exposed veins and a few samples were collected from the host rocks (hanging wall/footwall) to the veins. Rock grab samples and associated QA/QC standards and blanks were submitted for preparation and analysis at SGS Laboratories Ltd., (“SGS”) in Callao, Lima, Peru.

Kuya is independent of SGS Laboratories. SGS has international certifications OHSAS 18001, ISO 14001, and ISO 9001 and management is certified by INDECOPI under the NTP ISO IEC 17025:2006.

### **11.2.1 Sample Preparation and Analysis**

The samples were dried, crushed, quartered, and pulverized, separating a 140 mesh, 250-gram sample for analysis. They were then treated using a 4-Acid “Near Total” Digestion with subsequent analysis by ICP-OES finish for a suite of 36 elements, including Ag, Pb, Zn, Cu and Mo, and analysis by atomic absorption (“AA”) fire assay for Au.

Subsequently, samples with Ag concentrations greater than 100 ppm (above the ICP Ag upper detection limit), Pb concentrations greater than 10,000 ppm (above the ICP Pb upper detection limit), Cu concentrations greater than 10,000 ppm (above the ICP Cu upper detection limit), Zn concentrations greater than 10,000 ppm (above the ICP Zn upper detection limit) were analyzed by flame atomic absorption.

### **11.2.2 Quality Assurance/Quality Control**

A Quality Assurance/Quality Control (“QA/QC”) program, consisting of the regular insertion of Certified Reference Material (“CRM”) standards and blanks into the sample stream by Kuya personnel, was implemented on site. In addition, SGS monitored the sample preparation and analytical process with their own internal QA/QC practices (pulp blanks, standards, pulp duplicates and sieve tests on sample rejects and pulps). About 10% of the total samples submitted to the laboratory were QA/QC samples (Table 11-4). QA/QC samples were inserted into the sample stream at a rate of two samples per group of 20 samples using one CRM standard and one blank (alternating between using fine- and coarse-grained certified blanks).



Table 11-4: Summary of the number of primary and QA/QC samples taken and submitted to the laboratory as part of the 2021 surface vein sampling program.

Kuya Sampling	QA/QC Control	Recommended Insertion Rate	No. Surface Samples	%
Primary Samples	-	-	120	-
Coarse blanks	Contamination	1%	2	1.7%
Fine Blanks	Contamination	1%	3	2.5%
Low Grade	Standards	2%	3	2.5%
Medium Grade	Standards	2%	2	1.7%
High Grade	Standards	2%	2	1.7%
	<b>Overall Insertion Rate:</b>	<b>10%</b>	<b>132</b>	<b>10.0%</b>

### 11.3 Diamond Drilling (2021)

Kuya's Phase 1 diamond drilling program began on 18 March 2021 and was completed by 25 May 2021, totalling 36 holes and 4,988.05 meters. A total of 3,738 core and QA/QC (blank, standard and duplicate) samples were submitted for preparation and analysis at SGS in Callao, Lima, Peru.

Kuya is independent of SGS Laboratories. SGS has international certifications OHSAS 18001, ISO 14001, and ISO 9001 and management is certified by INDECOPI under the NTP ISO IEC 17025:2006.

Of the total 3,738 samples submitted, 3,256 were primary drill core samples and 482 were standards, blanks, or check duplicates (Table 11-5). Core recovery averaged about 98%.

Table 11-5: Summary of the number of the primary and QA/QC samples taken and submitted to the laboratory as part of the Kuya 2021 Phase 1 diamond drilling campaign

Kuya Sampling	QA/QC Control	Recommended Insertion Rate	No. Drill Core Samples	%
Primary Samples	-	-	3,256	-
Twin Samples	Sampling Precision	2%	161	4.9%
Coarse blanks	Contamination	1%	78	2.4%
Fine Blanks	Contamination	1%	82	2.5%
Low Grade	Standards	2%	54	1.7%
Medium Grade	Standards	2%	54	1.7%
High Grade	Standards	2%	53	1.6%
	<b>Overall Insertion Rate:</b>	<b>10%</b>	<b>3,738</b>	<b>14.8%</b>



### ***11.3.1 Core logging and Sampling***

#### ***11.3.1.1 Core Collection***

As drill core is retrieved from the core barrel at the drill rig, it is placed into plastic core trays or core boxes (each tray holds four meters of core). The core trays are labelled with the drill hole ID, core tray number, and the from-to interval. Core intervals in the core trays are marked with numbered plastic blocks.

An average of 10 boxes of core were collected from the drill hole platform every morning by the contract geological services group BISA and delivered to the core logging room. The core and trays were cleaned, then set out on the core logging tables where the core was oriented (turned) in order to be in a consistent orientation.

#### ***11.3.1.2 Core Logging***

A quick log of the drill core was generated daily and sent to management and others on the technical team to review. As core arrived at the main logging facility to be logged, it is ensured that the core has been cleaned and properly oriented. The main contacts (lithological, alteration and mineralization) are marked out. The quick log is completed in a clear and summarized way, characterizing the lithology, alteration, and mineralization. For the mineralization log, vein impacts or failure to reach veins, should be noted as “From” and “To” and mineralization intensity noted along with the interval. This information is recorded in an E-mail as this information is not entered into the final database.

The core boxes were arranged on the logging tables in an ascending correlative way, the technician recorded and reported on any poorly recovered or missing intervals, broken or damaged boxes, incorrectly placed core etc. The core was logged by the contract geologist and geotechnician, and information entered into Micromine’s Geobank™ Mobile logging and assay handling software.

The Senior Geologist responsible for logging the hole, selected and marked the sampling intervals, considering the contacts between geologically significant units based on:

- Lithology: type of rock.
- Alteration: type of alteration and degree of significant alteration.
- Mineralization: characteristics and intensity of the type of mineralization.
- Structures: such as veinlets, veins, faults, dikes, etc.

Sample intervals were marked by the geologist using a minimum sample length of 0.20 m and a maximum sample length of 2.00 m unless unusual circumstances dictated otherwise. Samples with less than 30% recovery would be assigned a sample ticket with the sample type as “IS” (insufficient sample) and the senior Geologist would then decide if and how the technician should or should not sample this section.

The Senior Geologist responsible for logging, marked the core using yellow or red chalk or crayon (China marker) by drawing a line along the axis of the core, in such a way that it divides the core exactly into two parts with equal proportions of mineralization for the drawing of the cutting line (sections to be sampled).

The selection, location and insertion percentage of QA/QC samples were carried out in accordance with the Quality Assurance/Quality Control protocols (standards, blanks, duplicates, etc.) developed by Kuya to acceptable standards.

Sampling intervals were coded onto sample stubs and recorded into the computer logging system. On the sampling stubs was recorded: drill hole name; From-To interval, sample type, geologist name, sampler name, and date (dd/mm/yyyy).

Once the hole was logged in its entirety the Senior Geologist reviewed the database for that entire hole to make sure there were no obvious errors, and that the logging and sampling had been completed together with proper QA/QC. Once the core was oriented, marked and logged, it was taken to the core cutting area to be cut and sampled.

#### ***11.3.1.3 Sampling***

Core cutting was completed using a diamond core table saw being careful to re-orient the core back into its original position in the core tray after cutting (Figure 11-1). After each core section was cut and sampled, the diamond saw blade was cleaned using a pumice stone or other cleaning block.



Figure 11-1: The on-site core cutting operation, completed by the geological service providers, BISA. (source: Simon Mortimer, 2021).

One half of the cut core was collected as a laboratory sample and placed into a plastic sample bag, which is labelled on both sides, the other half is kept in the core tray. A sample tag was placed into the sample bag with the laboratory core sample and the same sample number tag attached to the core tray at the start of the core interval from which the sample was collected. The sample number was also written on the half of core that was saved in the core tray. The sample bag is closed with a security seal. The sampled bag is weighed, and the information recorded on the sampling card.

The Senior Geologist coordinated the laboratory shipment sheets of the batches of samples for preparation and analysis. The geologist in charge, and the sampler and his assistant, verified the correct order and identification of the samples being prepared for shipment.

### 11.3.2 Sample Storage and Security

After the core was logged and sampled on the Property, it was temporarily stored in a secure warehouse near the core logging facility (Figure 11-2). Core samples were placed in a safe and secure location prior to shipment to the laboratory. Core samples were shipped to SGS Lima by truck using a bonded courier service. By the end of the drilling program, all of the cores were shipped to Lima and is stored in a safe and secure warehouse. The core sample pulps and rejects from the laboratory were returned to Kuya and stored at the same warehouse.



Figure 11-2: The on-site secure sample storage facility with labelled nylon sacks containing the individual samples, ready and waiting shipment to the laboratory in Lima (source: Simon Mortimer, 2021).

### 11.3.3 Analytical - Sample Preparation and Analysis

At SGS, the core samples were dried, crushed, quartered, and pulverized, separating a 140 mesh, 250-gram sample for analysis. They were then treated using a 4-Acid “Near Total” Digestion with subsequent analysis by ICP-OES finish for a suite of 36 elements, including Ag, Pb, Zn, Cu and Mo, and the fire assay analysis for Au.

Subsequently, samples with Ag concentrations greater than 100 ppm (above the ICP Ag upper detection limit), Pb concentrations greater than 10,000 ppm (above the ICP Pb upper detection limit), Cu concentrations greater than 10,000 ppm (above the ICP Cu upper detection limit), Zn concentrations greater than 10,000 ppm (above the ICP Zn upper detection limit) were analyzed by flame atomic absorption.

### 11.3.4 Quality Assurance/Quality Control

A QA/QC program consisting of the regular insertion of Certified Reference Material standards (see Table 11-1, Table 11-2 and Table 11-3) and blanks and quarter core duplicates into the sample stream by Kuya Silver was in place as well as the industry standard internal QA/QC practices used by SGS.

About 15% of the total samples submitted to the laboratory were QA/QC samples. QA/QC samples were inserted into the sample stream at a rate of three samples per group of 20 samples using one CRM, one blank, and one core duplicate. All CRMs used in the diamond

drilling program are the same used in the surface vein sampling program (see Section 11.1.3) (see Table 11-1, Table 11-2 and Table 11-3).

During the Phase 1 2021 drilling program, 3,738 samples were analyzed, 3,256 of those were from drill core and 482 were QA/QC control samples, 160 blanks, 161 CRM standards, and 161 duplicates.

The analyses of the CRMs were plotted on a graph with the expected mean and  $\pm 1$ ,  $\pm 2$  and  $\pm 3$  times the expected standard deviation. The Figure 11-3, Figure 11-4 and Figure 11-5 show the variation of the analyses of the PLSUL29, PLSUL30, and PLSUL31 respectively, throughout the drill campaign.

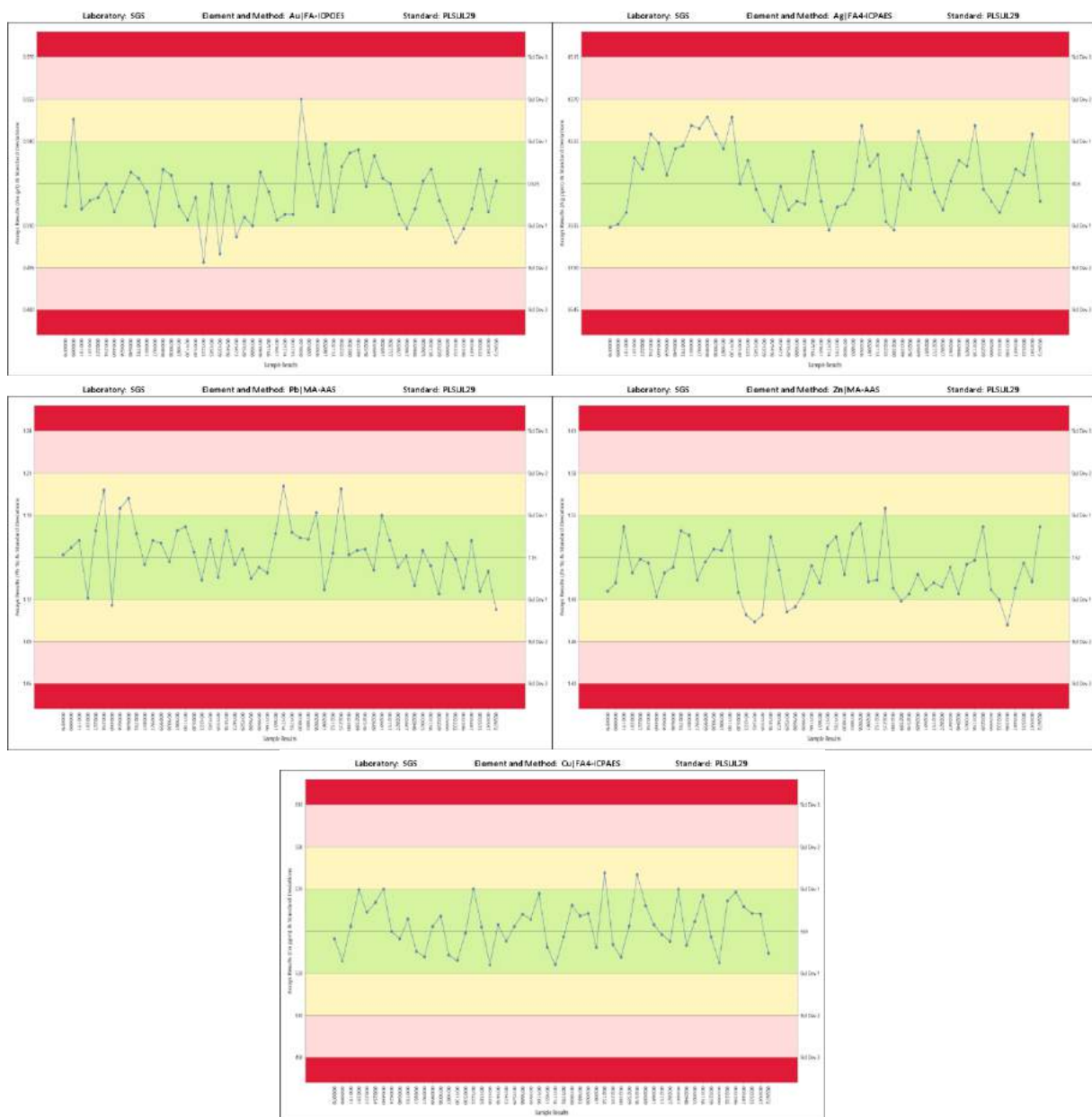

Figure 11-3: QC/QC analyses for Au, Ag, Pb, Zn and Cu of the CRM PLSUL29



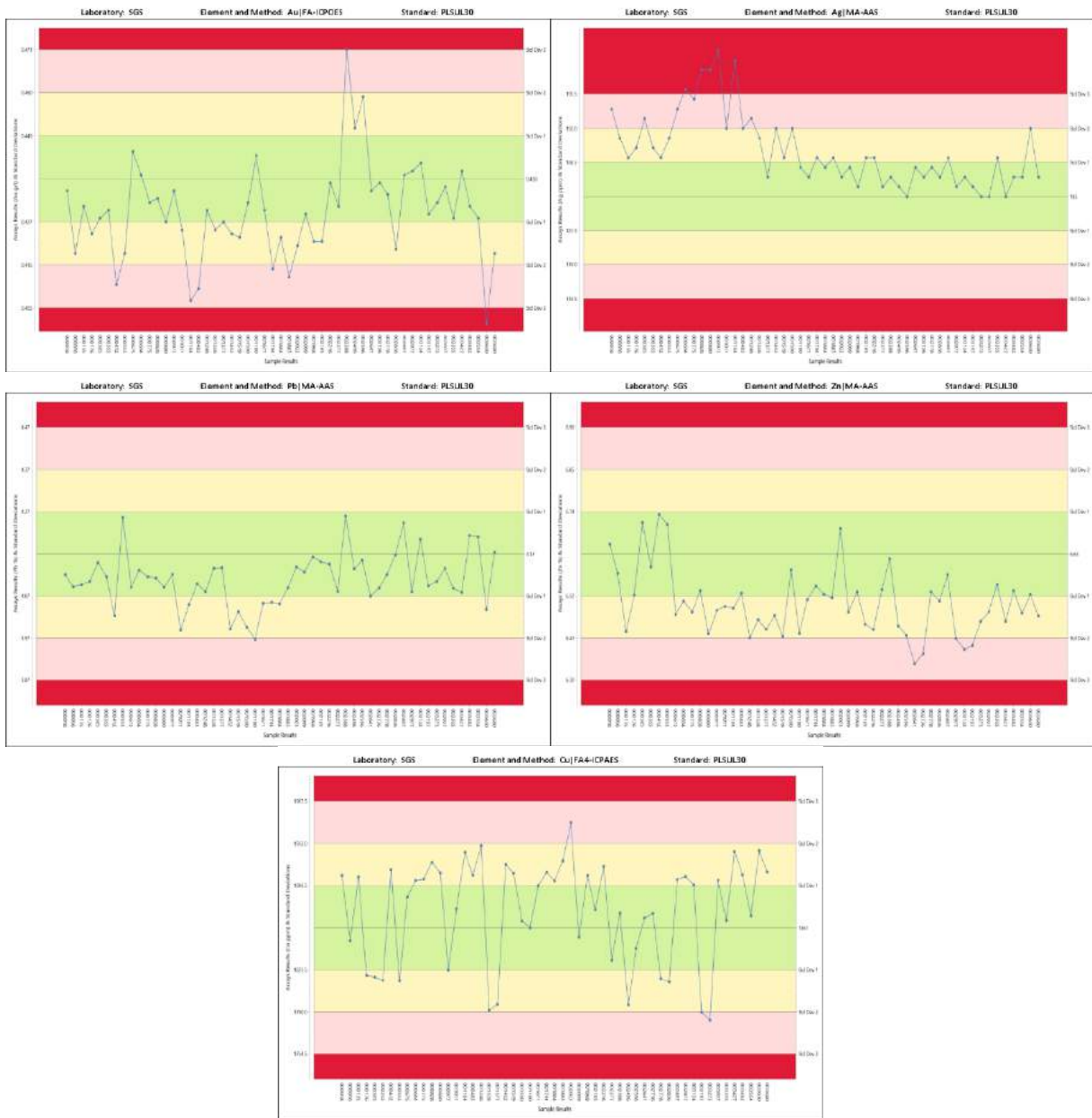

Figure 11-4: QA/QC analyses for Au, Ag, Pb, Zn and Cu of the CRM PLSUL30



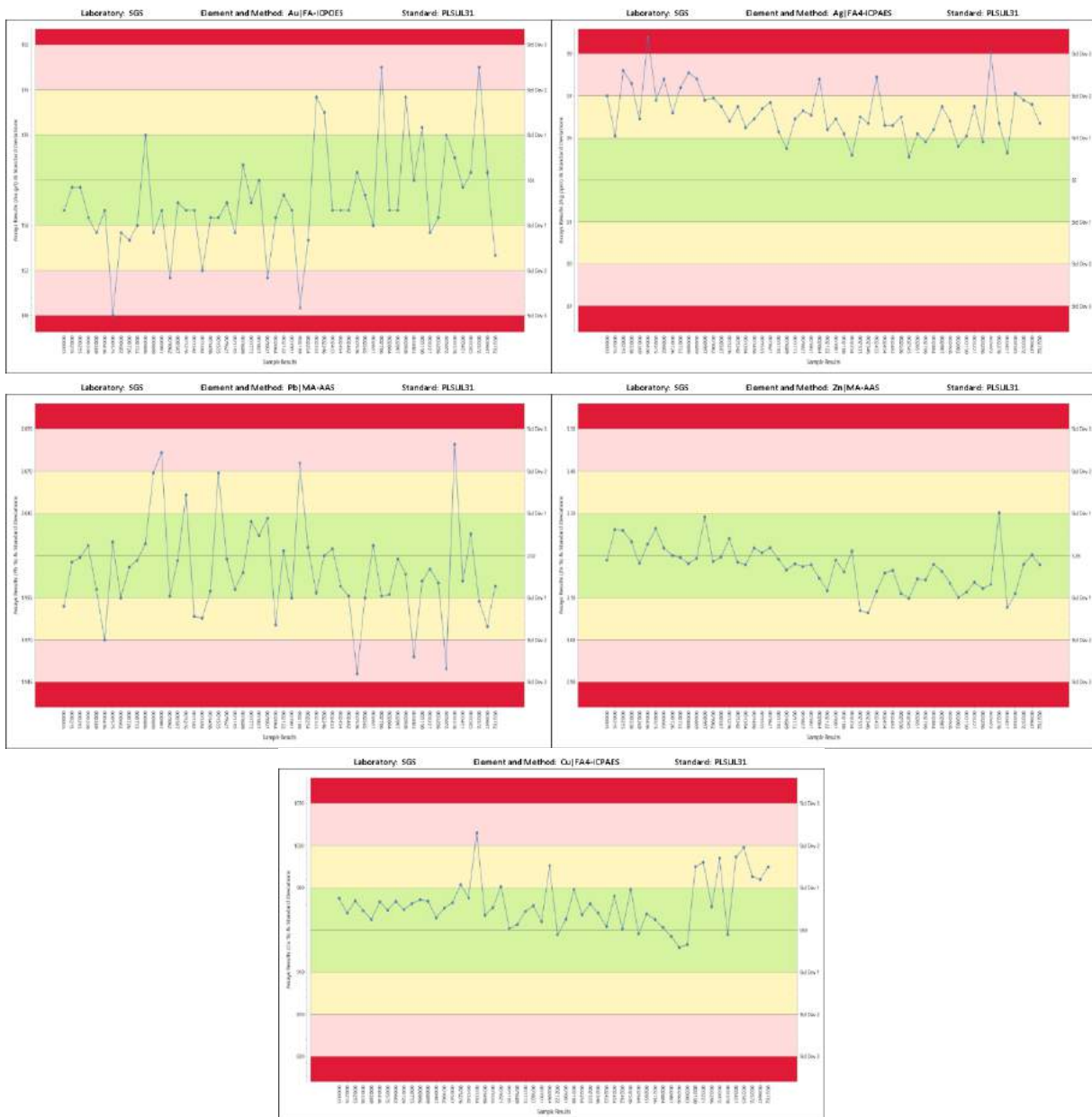

Figure 11-5: QA/QC analyses for Au, Ag, Pb, Zn and Cu of the CRM PLSUL30

The analyses of the low-grade CRM (PLSUL29) show a good correlation with the expected mean for all the reviewed elements. The high-grade CRM (PLSUL30) returns more variable results for gold and lead, but still within recognized standard limits; however, the copper and silver display a bias, returning a higher-than-expected assay value. The medium grade CRM (PLSUL31) still shows bias for silver and copper albeit slightly less. The variations from the expected values for the higher and medium grade materials are because the expected results and the standard deviations of the expected are based upon aqua-regia digestion while the samples in this campaign were analyzed using a four-acid digestion process.

The use of Blanks in the QA/QC program is to monitor possible contamination in the pulverizing process of sample laboratory. The materials used for blanks used were selected by Actlabs and certified by Target Rocks. The 160 blanks that were inserted into the sample

stream comprised 82 fine grained blank samples and 78 coarse blank samples. The expected result for the coarse blanks is five (5) times the detection limit and for the fine-grained blanks three (3) times the detection limit. The Figure 11-6 and Figure 11-7 details the results from the analyses of the coarse blanks and the fine-grained blanks, respectively.

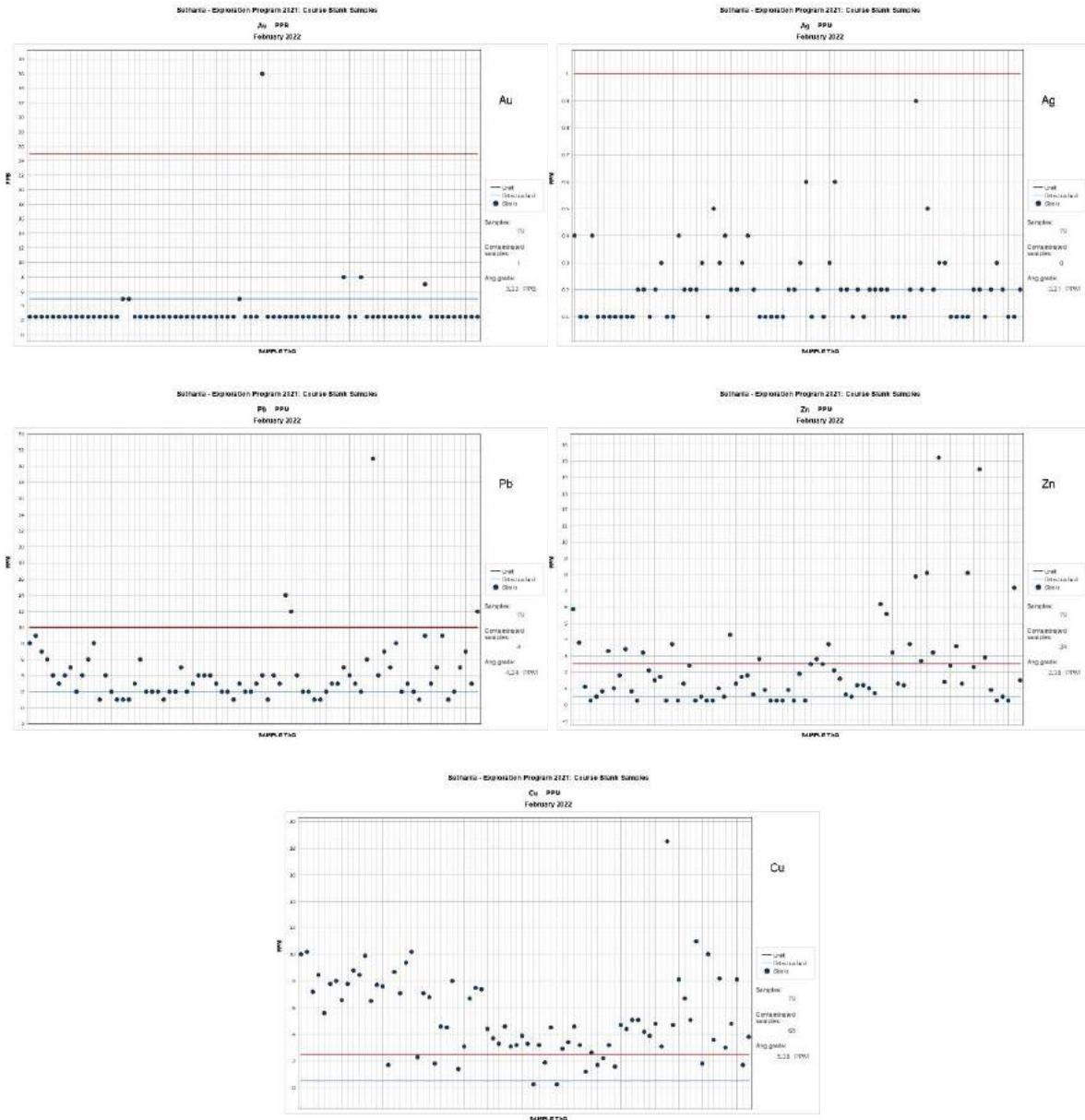

Figure 11-6: QA/QC analyses of the Course Blanks for Au, Ag, Pb, Zn y Cu

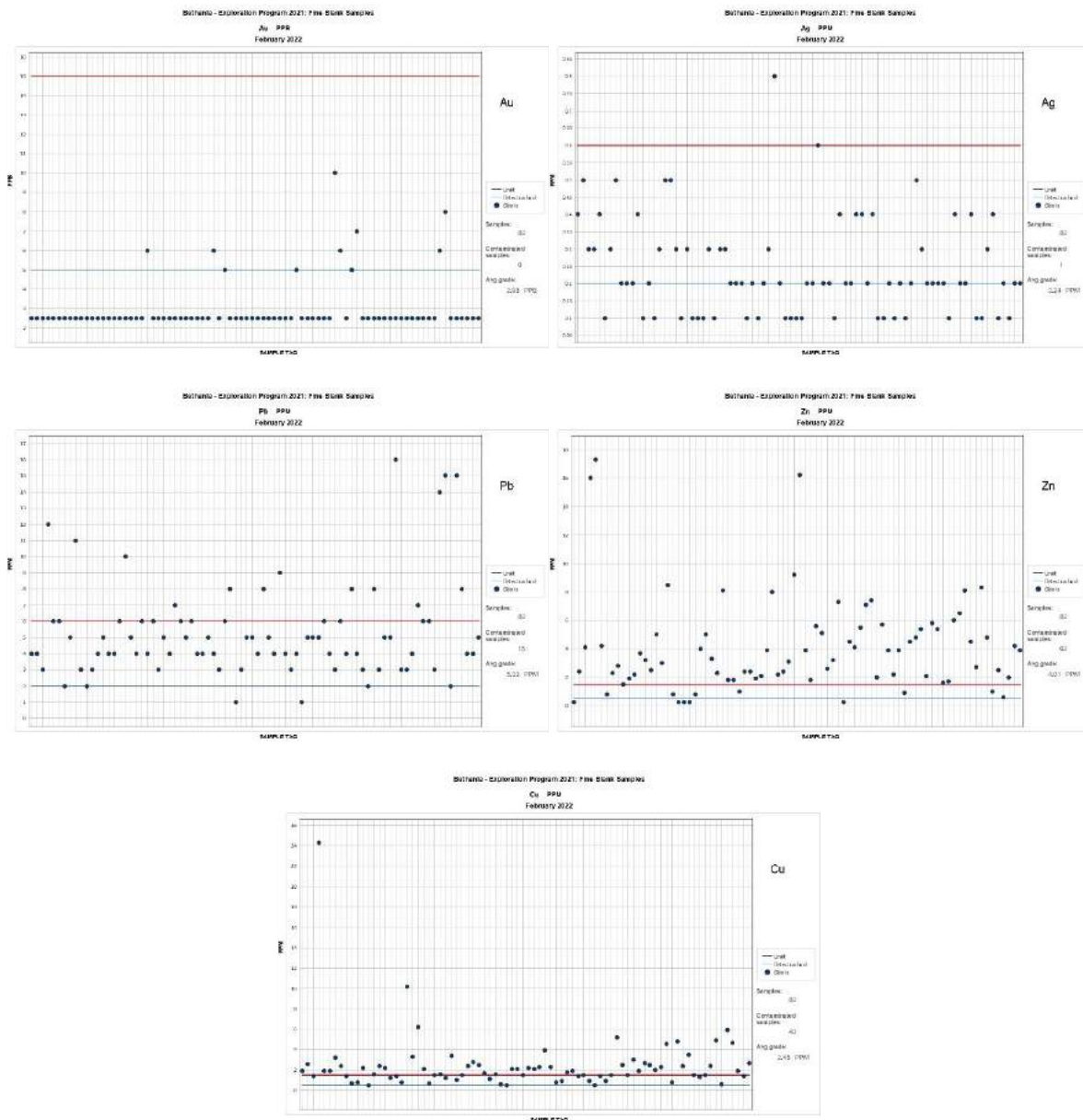

Figure 11-7: QA/QC analyses of the Course Blanks for Au, Ag, Pb, Zn y Cu

In both the fine-grained and large-grained blanks the results for Ag, Pb and Au are all below the established limit; however, the values returned for zinc and copper do not appear to correspond with the detection limits that have been applied in the upper limit calculation. This observation is being reviewed.

A total of 161 quarter-core field duplicates were analyzed, and the respective Max-Min graphs were prepared for the pair analyses of Au, Ag, Pb, Zn and Cu. The data was plotted against the line  $x=y$  for the lower limit and the curve  $y^2=m^2x^2+b^2$ , where  $m=1.35$  and  $b =20x$ , for the upper limit; a parameter commonly applied for core duplicates. Figure 11-8, Figure 11-9, Figure 11-10, Figure 11-11, Figure 11-12 show the duplicate analysis graphs for gold, silver, lead, zinc, and copper, respectively.

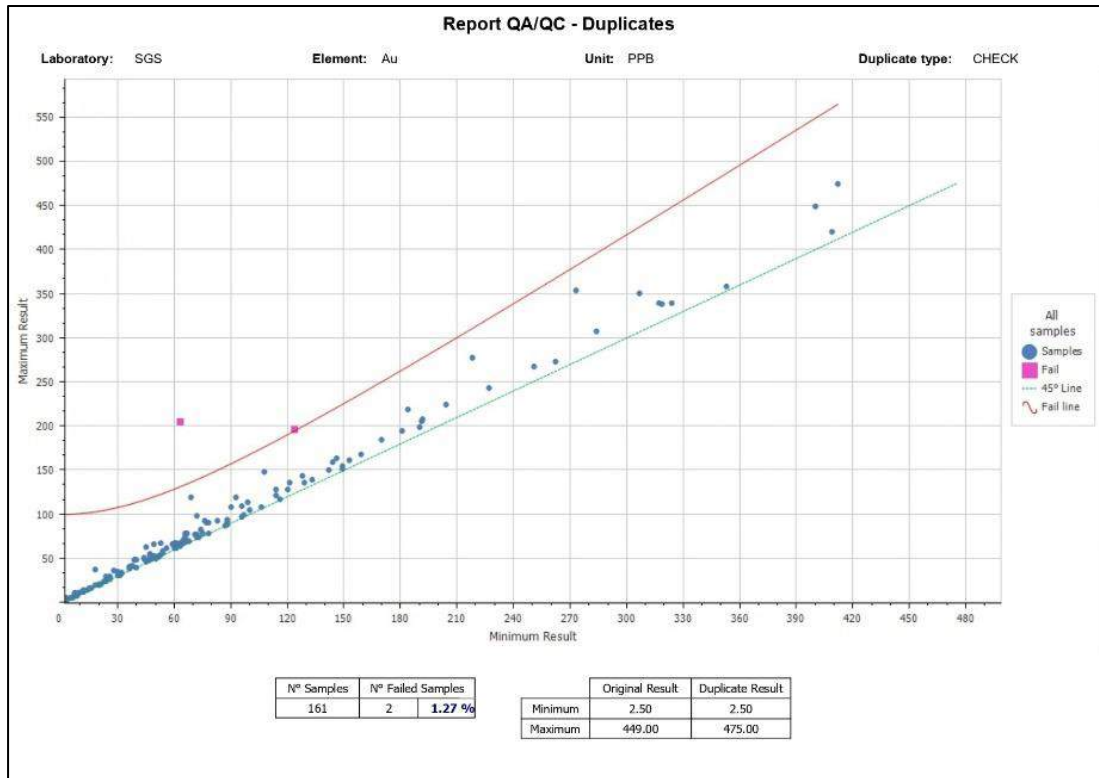

Figure 11-8: Duplicate Sample Analysis for Au

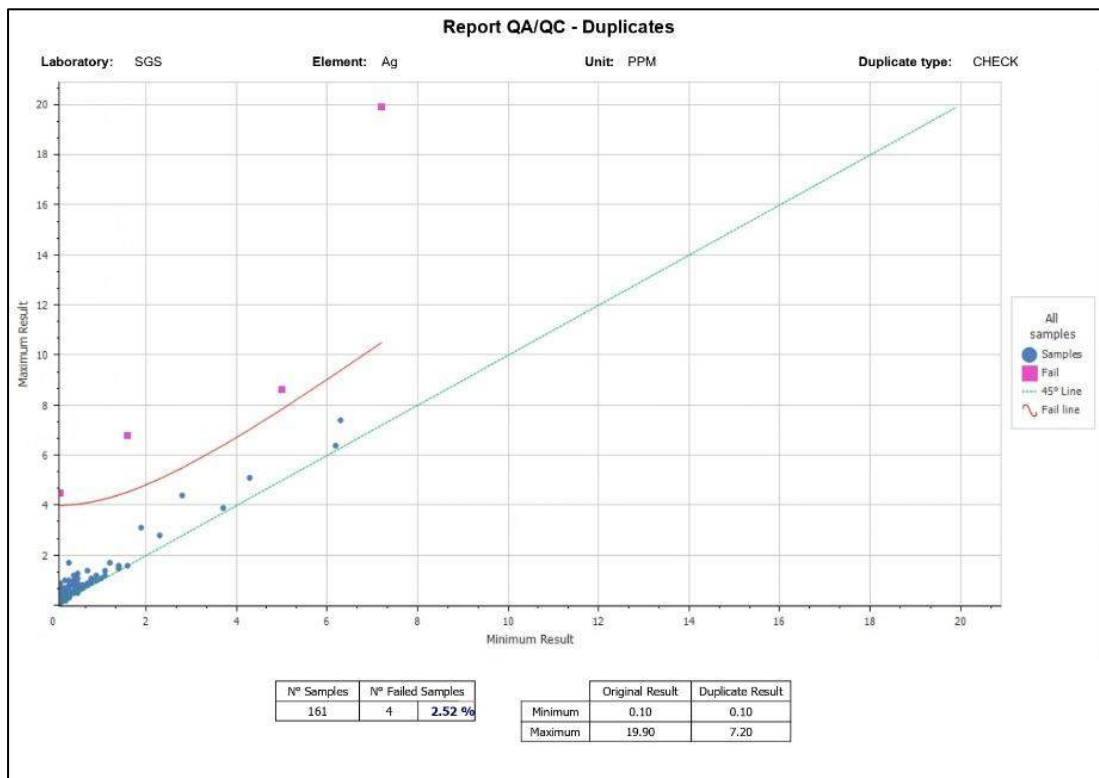

Figure 11-9: Duplicate Sample Analysis for Ag

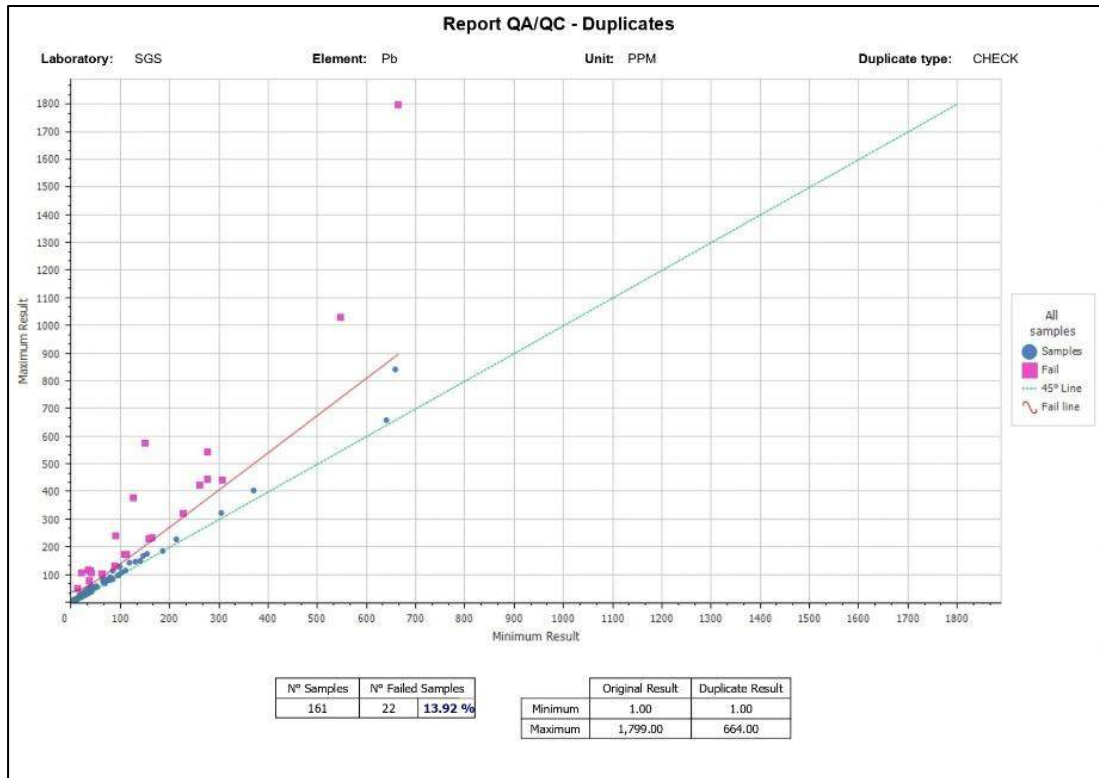

Figure 11-10: Duplicate Sample Analysis for Pb

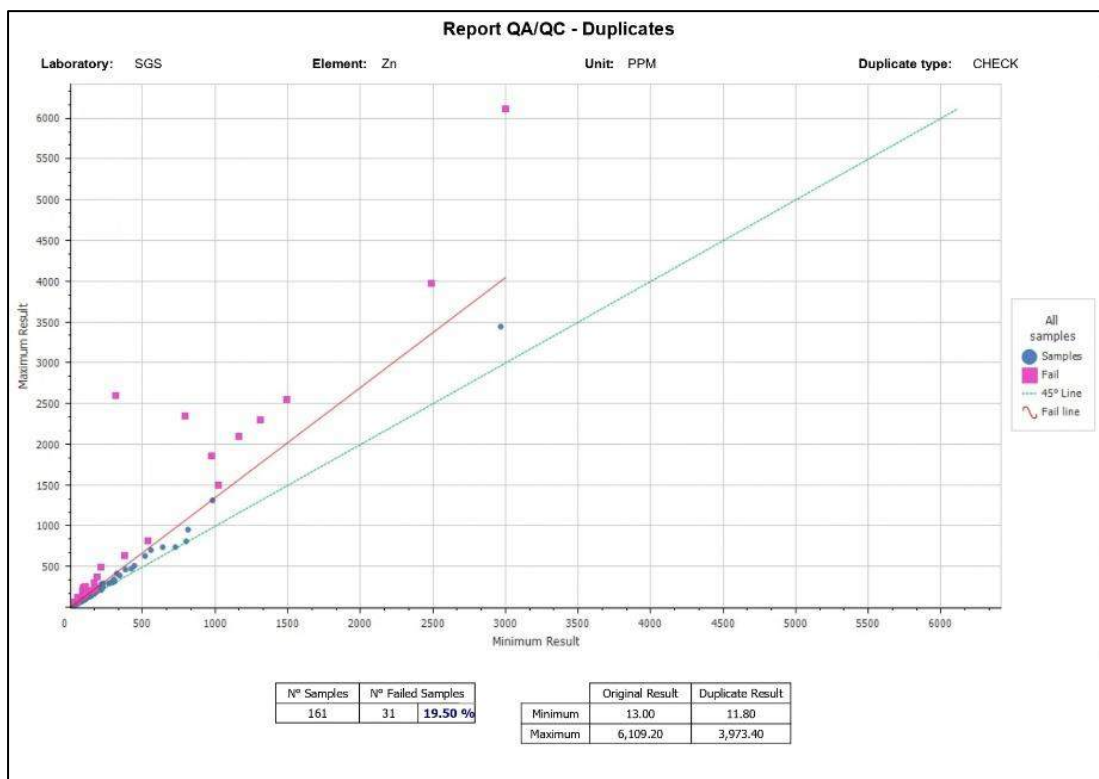

Figure 11-11: Duplicate Sample Analysis for Zn



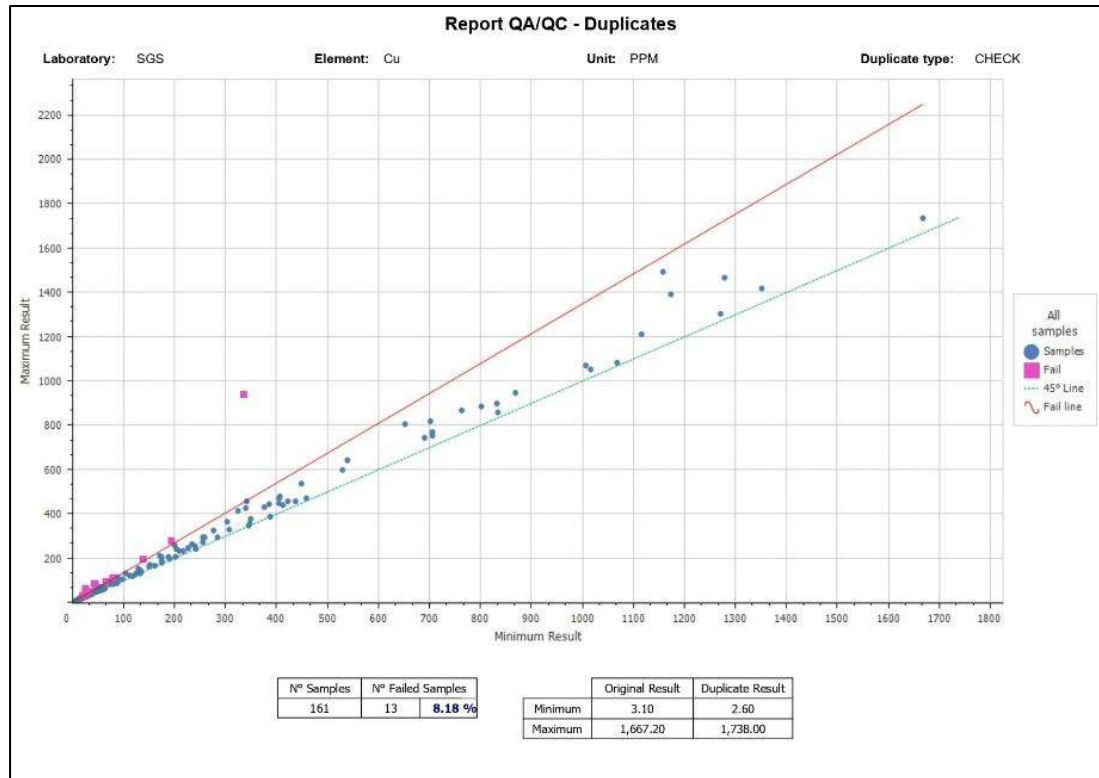

Figure 11-12: Duplicate Sample Analysis for Cu

In total, 13 analyses (8.18%) were identified as failing the duplicate criteria for copper, 2 analyses (1.27%) for gold, 4 analyses (2.52%) for silver, 31 (19.5%) for zinc and 22 (13.92%) for lead. An acceptable limit for the duplication of analyses is around 10%. Therefore, it is concluded that the sampling precision with respect to Au, Ag and Cu are acceptable. However, as it is only the lead and zinc duplicate analyses that have observed a decrease in precision it is more likely that this is an effect of the core splitting, as it is known that the lead and zinc mineralogy is less homogenous than the silver, gold, and copper.

### 11.3.5 Density Measurements

As part of the geological logging process, it was noted that the drilling did not cut through many examples of vein material, and once the assay data was returned it was evident that the mineralization is not only in vein material but also in mineralized wallrock, which would have a different density to the vein. A density sampling program was devised once the vein modelling was completed, and the mineralized drill intervals were known.

A total of fifty-nine (59) samples were taken from the different vein sets. Statistical analysis of the results of the density measurements showed two distinct populations, one for the denser vein material, and a second lighter material similar to that of un-altered volcanics, considered to be mineralized host rock. A histogram indicated an average specific gravity of 2.71 g/cm<sup>3</sup> for the mineralized wallrock and 3.1 g/cm<sup>3</sup> for the vein material (Figure 11-13).



The samples were taken by Atticus Consulting’s consulting geologists, selecting one sample per mineralized interval of a unified piece of half core between 10 cm and 15 cm in length. The density samples were sent to SGS laboratories in Callao to be measured in paraffin. The samples were returned to the Kuya after the laboratory analysis.

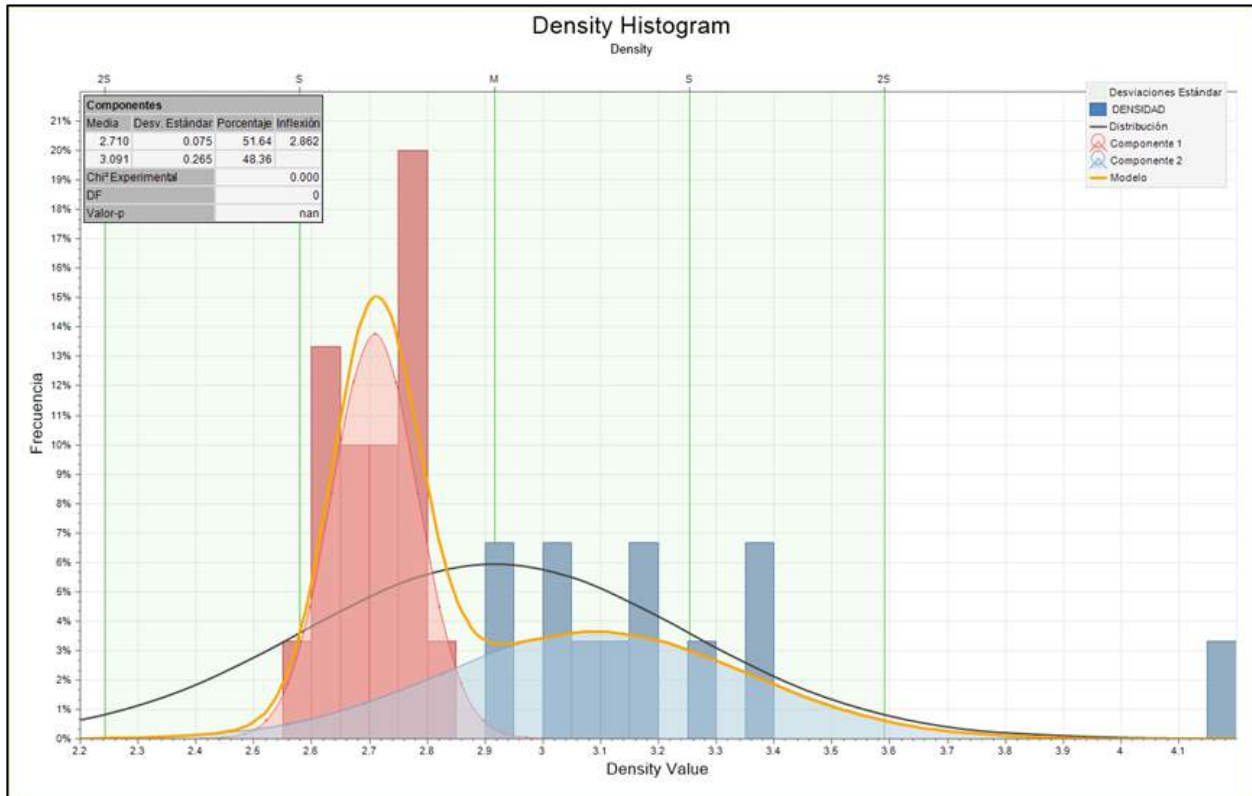

Figure 11-13: Statistical analysis of the 59 density measurements, showing two separate populations with average readings of 2.71 and 3.1 for the two types of mineralized material, vein, and host rock

## 12 DATA VERIFICATION

---

The Authors have reviewed the historical data and information regarding past exploration, development work, and historical mining on the Property as provided by Kuya. Kuya was entirely cooperative in supplying the Authors with all the information and data requested and there were no limitations or failures to conduct the verification.

Dr. Scott Jobin-Bevans (P.Geo., APGO #0813), visited the Bethania Silver Project for one day on 15 June 2019. The purpose of the personal inspection (site visit) was to observe mine and general Property conditions, surficial geology, underground geology, and mining procedures, proposed sites for the processing plant and related equipment, and sites for any exploration work including historical surface trenching and excavation (past mining), inclusive of associated quality assurance/quality control. During the site visit, a total of five rock samples were collected from five of the main veins, either from surface exposures or from underground workings, and analyzed.

Mr. Simon Mortimer (FAusIMM, FAIG), visited the Bethania Silver Project from the 24 to 27 May 2021 on behalf of Caracle Creek International Consulting Inc. Simon was accompanied by geologist Luis Huapaya, also from Atticus Consulting S.A.C., Lima, Peru. The purpose of the personal inspection was to observe the processes and protocols in place for the collection of geological data – the geological logging, the capture of data in digital format, the selection, taking, and registering of samples, the associated quality assurance/quality control, and the transport and storage of the samples; to visit the drip pads and observe the procedures in place for the extraction of the core and delivery to the logging shed; and to review the drill core, the surface geology and map some of the principal structures, contacts and outcropping veins.

Past mine production data as reported to the Ministry of Energy and Mines during the period 2013-2016 is evidence that the mine was worked to accepted standards, and although it should be recognised that geological data relating this last period of mine working lacks QA/QC support, mine mapping and sampling is noted to be of a high standard, and the authors are confident that this data can be used for guidance in the planning of future work programs and for the purposes of geological modelling and inclusion in mineral resource estimation.

Edgard Vilela (MAusIMM, #992615), visited the Bethania Silver Project for one day on 22 January 2022, the field visit was developed to verify the location of the existing components, possible infrastructures to be installed, existing mine entrances and the inclined shaft.

For the mining section, the information provided by Kuya Silver has been reviewed, which includes the available underground topography (2D and 3D), current Environmental Impact

Statement (DIA), resource model, location of surface mining infrastructure, access roads and projection of the new components to be built (tailings and plant).

Laurie Tahija, (Bsc Mineral Processing Engineering, MMSA-QP) understands that the laboratories ETUDES METALLURGIQUES ET D 'ENGINEERING EIRL (EMEDE) and ED&ED Ingeniería y Servicios SAC are no longer in operation. The QP did not visit the laboratories. The QP believes that tests were performed using standard quality assurance / quality control (QA / QC) procedures. The QP reviewed all available test work between 2001 and 2021 and well as past production to form an opinion regarding the mineral processing and metallurgical testing.

All the QP's are of the opinion that the data available is adequate for the purposes of the PEA report in their respective areas of responsibility.

## 13 MINERAL PROCESSING AND METALLURGICAL TESTING

Between 2001 and 2021, metallurgical tests work programs were completed for the Bethania project mineralized material. Minera Toro de Plata (previously S&L Andes Export SAC Company) hired external laboratories to carry out the preliminary metallurgical tests of the samples from the Santa Elena mine.

The objective of the preliminary metallurgical program was to develop the flotation conditions for the recovery of lead, zinc, and other commercial metals and to identify possible issues in the treatment of the samples. Considering as background that the mineral from Santa Elena mine is a polymetallic Cu-Pb-Ag-Zn with a great metallurgical response and processed in several Peruvian mining plants.

The test work programs were carried out in the following laboratories in Lima -Peru:

- 1 ETUDES METALLURGIQUES ET D 'ENGINEERING EIRL (EMEDE) in 2001-2011-2012.
- 2 ED&ED Ingeniería y Servicios SAC in 2013.
- 3 Universidad Nacional de Ingeniería (UNI) in 2014-2015.
- 4 Laboratorio Metalúrgico Chapi in 2021.

The QP understands that the laboratories ETUDES METALLURGIQUES ET D 'ENGINEERING EIRL (EMEDE) and ED&ED Ingeniería y Servicios SAC are no longer in operation. The QP did not visit the laboratories. The QP believes that tests were performed using standard quality assurance / quality control (QA / QC) procedures. The following sections refer to the work conducted by the laboratories with regards to the metallurgy of the mineral samples.

Between January 2013 and August 2016, campaigns were carried out at an industrial level. A summary of the processed mineral and the recoveries of the lead and zinc concentrates is shown in the following Table 13-1:

*Table 13-1: Summary of the production of the Santa Elena mine (2013 - 2016)*

Period	2013	2014	2015	2016
<b>Concentrator Plant</b>	Huari San Pedro	San Pedro	San Pedro Azulcocha	Azulcocha
<b>Production</b>				
Metric Tonnes	20,235	26,542	16,621	3,213
<b>Grades</b>				
Ag (oz/t)	11.67	11.50	14.11	8.18
Pb %	3.12	2.04	3.38	2.80
Zn %	1.57	1.96	2.59	1.29
<b>Lead Concentrate</b>				
Metric Tonnes	1,332	1,013	968	172
Pb %	44.12	47.46	54.45	45.34
Ag (oz/t)	155.75	247.16	196.71	119.08
Recovery Pb%	93.1%	88.9%	93.8%	86.5%

Period	2013	2014	2015	2016
<b>Zinc Concentrate</b>				
Metric Tonnes	352	663	627	39
Zn %	35.19	49.11	51.44	41.85
Ag (oz/t)	18.51	29.01	33.77	24.08
Recovery Zn%	39.0%	62.5%	74.9%	39.5%

### 13.1 Samples

The composite samples were delivered by S&L Andes Export SAC company to external laboratories for preparation, assays and development of comminution, grinding and flotation tests. S&L Andes Export SAC Company indicated that all samples came from the Santa Elena mine.

The head assays of the composite samples were conducted to determine lead, silver, zinc, copper, arsenic, and antimony. A summary of the results of the head assays are presented in Table 13-2.

*Table 13-2: Summary of the Composite Head Assay Results*

ID - Sample	% Pb	Ag oz/st	% Zn	% Cu	% As	% Sb
Composite - 2001	2.81	17.94	1.98			
Composite - 2011	10.99	31.42	4.07	0.54	0.21	
Composite - 2012	0.72	4.65	1.18	0.16	0.09	0.06
Composite - 2013	2.21	6.51	0.73	0.13	0.07	0.05
Composite - 2014	1.43	12.60	2.02	0.18		
Composite - 2015	5.20	13.08	2.79	0.22		
Composite - 2021	7.88	50.43	8.53	0.82	0.15	0.53

The QP was not involved in the collection of samples used for testing for the study. Since the metallurgical samples have similar distributions of grades for the material to be processed, it is believed that the samples are suitably representative for a PEA level study.

### 13.2 Mineragraphic Results

The deposit is a polymetallic hydrothermal deposit (Ag - Pb - Zn - Cu - Au). The studied samples consist of sedimentary and sub-volcanic rocks. Silver occurs as gray coppers (possible tetrahedrite). The native gold has been located within the pyrite.

In 2011, the S&L Andes Export SAC company hired an external laboratory to carry out a mineragraphic study of three polished sections. The Table 13-3 shows the mineragraphic results. The information was taken from the October 2011 laboratory report by Alberto Aranda Vercelli.

Table 13-3: Mineragraphic Results

Name	Formula	Distribution %
Chalcopyrite	CuFeS <sub>2</sub>	-
Pyrite	FeS <sub>2</sub>	10
Sphalerite	ZnS	2
Galena	PbS	5
Bornite	Cu <sub>5</sub> FeS <sub>4</sub>	-
Gray Coppers	Cu <sub>5</sub> Fe <sup>2+</sup> <sub>3</sub> Sb <sub>4</sub> S <sub>13</sub>	2
Gold	Au	-
Argentite	AgS <sub>2</sub>	-
Boulangerite	Pb <sub>5</sub> Sb <sub>4</sub> S <sub>11</sub>	-

### 13.3 Comminution test

In 2021, comminution test work was carried out to determine the grinding energy required to liberate lead, silver, and zinc minerals prior to flotation. Bond ball mill work index (BWi) test work was performed using a cut mesh of 100M Tyler. The results are presented in Table 13-4. Based on the sample result, the Santa Elena material can be ranked as medium hardness.

Table 13-4: Bond Ball Mill Work Index Result

ID	Sieve Size (µm)	Grams per Revolution (g/rev)	F <sub>80</sub> (µm)	P <sub>80</sub> (µm)	Bond Ball Mill Work Index (kWh/st)
Composite – 2021	150	1.67	1697	115	13.37

Bond abrasion test was also conducted to determine potential wear rates for the crushing and grinding equipment. The result is summarized in Table 13-5. The Bond abrasion index was 0.0996, the sample has low abrasiveness. Therefore, a low consumption of steel is expected in the crushing and grinding of Santa Elena mineralized material.

Table 13-5: Bond Abrasion Index Result

ID – Sample	Ai (g)
Composite – 2021	0.0996

### 13.4 Grinding Tests

Between 2014-2015 grinding tests were performed to determine the grinding curve of the polymetallic mineral. The samples were ground in a mill at 0, 15, 20, 25, and 30 minute intervals. The results are summarized in Table 13-6. The reports do not indicate whether the lab mill was a ball mill or a rod mill.



Table 13-6: Grinding Test Results 2014 and 2015

Composite – 2014		Composite – 2015	
Time (min)	% -200 m	Time (min)	% -200 m
0	30.19	0	25.50
15	62.62	15	55.51
20	73.21	20	67.12
25	82.63	25	77.78
30	91.22	30	87.73
55% -200m = 11' 49"		55% -200m = 11' 49"	
60% -200m = 13' 52"		60% -200m = 14' 48"	
65% -200m = 16' 04"			

To test the effects of grinding, flotation tests were completed (2014 -2015), and results of the bulk and selective flotation (cleaner) tests are provided in Table 13-12 and Table 13-13.

In 2015, a particle size distribution test was also completed on the sample which determined that 44.92% of the mineralized material sample is less than +1/2", a high percentage that can be separated before crushing/grinding.

In 2021, a grinding tests was performed at 10, 15, 20, and 25 minute intervals to establish the relationship between the grind sizes (P80) and grind times. These tests were completed in a rod mill (12" x 18").

Table 13-7: Grinding Test Results-2021

Composite – 2021	
Time (min)	P <sub>80</sub> (µm)
10	376
15	255
20	189
25	151

In this test, the grinding time was 21' 22" for a P80 of 180 µm. This grind was used to performed four flotation testwork and results are provided in Table 13-7.

### 13.5 Flotation Results

The circuit used for the testing is a conventional circuit and the reagents are typical of the industry for this type of mineral (polymetallic Cu-Pb-Ag-Zn).

#### 13.5.1 Flotation Test – 2001

For this test, four samples taken from the Santa Elena mine were homogenized. Galena (PbS) and sphalerite (ZnS) were identified at a macroscopic level, with gangue minerals pyrite

(FeS<sub>2</sub>), quartz and carbonate. The head assay for this composite was 2.81% Pb, 1.98% Zn, 19.78 oz/t Ag. Flotation test results are shown in Table 13-8.

*Table 13-8: Flotation Test Result – 2001, Santa Elena mine*

Product	Concentrate Grade		Recovery	
	Pb (%)	Ag (oz/t)	Pb (%)	Ag (%)
Concentrate	51.43	176.67	93.17	74.32
Tailings	0.41	7.06	6.83	25.68

### 13.5.2 Flotation Test – 2011

The objective of this study was to obtain Pb – Ag – Au and Zn – Ag concentrates. Galena (PbS) and sphalerite (ZnS) were identified at a macroscopic level, with gangue minerals as pyrite (FeS<sub>2</sub>), quartz (SiO<sub>2</sub>). The head grade for this composite was 1.50 g/t Au, 31.42 oz/st Ag, 0.21% As, 10.99% Pb, 4.07% Zn, 0.54% Cu. Flotation test results are shown in Table 13-9.

*Table 13-9: Flotation Test Result – 2011, Santa Elena mine*

Product	Concentrate Grade						Recovery		
	Au (g/t)	Ag (oz/st)	Pb (%)	Zn (%)	Cu (%)	As (%)	Ag (%)	Pb (%)	Zn (%)
Concentrate Pb -Ag	3.15	192.49	68.11	2.65	3.09	0.83	90.98	93.75	10.57
Concentrate Zn - Ag	0.80	20.44	4.64	55.77	-	-	3.02	2.00	70.52
Tailings	0.91	2.22	0.54	0.82	-	-	6.00	4.25	18.91

The study recommended industrial level treatment and it was cautioned that gold may be intimately associated with the pyrite.

### 13.5.3 Flotation Test – 2012

The objective of this study was to obtain Pb - Ag - Au and Zn - Ag concentrates and to control the content of arsenic (As) during flotation. Galena (PbS) and sphalerite (ZnS) were identified at a macroscopic level, with gangue minerals as pyrite (FeS<sub>2</sub>), quartz (SiO<sub>2</sub>). The head assay for this composite was 0.023 oz/st Au, 4.65 Oz/st Ag, 0.09% As, 0.72% Pb, 1.18% Zn, 0.16% Cu. Flotation test results are shown in Table 13-10.

*Table 13-10: Flotation Test Result – 2012, Santa Elena mine*

Product	Concentrate Grade					Recovery		
	Ag (oz/st)	Pb (%)	Zn (%)	Cu (%)	As (%)	Ag (%)	Pb (%)	Zn (%)
Concentrate Pb-Ag	68.51	19.26	3.21	1.63	0.55	72.86	71.37	14.24
Concentrate Zn-Ag	26.30	4.30	52.00	-	-	9.51	5.42	78.41
Tailings	0.90	0.34	0.09	-	-	17.67	23.21	7.35

The low grade of Pb concentrate (19.26%) was due to the presence of iron. The high arsenic content was controlled by using arsenic depressant during flotation.

#### 13.5.4 Flotation Test – 2013

Two metallurgical tests were carried out to obtain Pb and Zn concentrate. Identified sulphides included galena, sphalerite, pyrite, and to a lesser extent gray coppers and quartz-type gangue. The head assay of the sample was 223.11 g/t Ag, 0.49 g/t Au, 2.21% Pb, 0.73% Zn, 0.13% Cu, 0.05% Sb and 0.07% As. Specific gravity was 2.79 and natural pH of the sample was 5.55. Flotation tests results are shown in Table 13-11.

Table 13-11: Flotation tests results - 2013, Santa Elena mine

SELENA - 1 /Product	Cond.	Concentrate Grade					Recovery		
		Ag (g/t)	Pb (%)	Zn (%)	As (%)	Sb (%)	Ag (%)	Pb (%)	Zn (%)
Concentrate Pb	50% - 200m	4877.45	52.11	6.01	0.87	0.42	70.44	75.61	-
Concentrate Zn		580.65	6.23	47.11	0.29	0.19	2.84	-	61.74
SELENA - 2 /Product		Ag (g/t)	Pb (%)	Zn (%)	As (%)	Sb (%)	Ag (%)	Pb (%)	Zn (%)
Concentrate Pb	60% - 200m	4990.32	53.98	5.84	0.91	0.50	77.48	80.09	-
Concentrate Zn		480.25	4.82	48.67	0.33	0.21	2.04	-	60.76

It is observed that the SELENA-2 sample has better metallurgical response due to finer grinding and arsenic (As) and antimony (Sb) contents in the concentrates are moderate.

#### 13.5.5 Flotation Test – 2014

Prior to flotation tests, grinding test were performed to determine the optimum time for flotation grinding time. Also, four different flotation tests were carried out at different conditions. The head grade of the sample was 1.43% Pb, 13.89 oz/t Ag, 2.02% Zn and 0.18% Cu. Flotation tests results are shown in Table 13-12.

Table 13-12: Result of recoveries from flotation tests - 2014, Santa Elena mine

N° Test	Cond.	Concentrate Grade						Recovery			
		Ag (oz/t)	Pb (%)	Zn (%)	Cu (%)	As (%)	Sb (%)	Ag (%)	Pb (%)	Zn (%)	Cu (%)
1 - Concentrate Bulk	65% - 200m	293.08	57.27	4.04	3.22	0.71	2.72	93.29	91.81	37.43	82.37
1 - Concentrate Zn		12.67	1.26	60.28	0.24	0.25	0.19	4.15	3.87	60.07	7.59
2 - Concentrate Bulk	65% - 200m	297.20	61.14	3.58	2.96	0.74	2.35	92.77	94.64	16.48	78.68
2 - Concentrate Zn		15.59	0.40	64.47	0.19	0.06	0.08	4.13	1.69	80.18	6.57
3 - Concentrate Bulk	60% - 200m	320.00	60.70	3.93	2.95	0.54	1.80	88.77	92.94	13.14	71.09
3 - Concentrate Zn		22.00	0.87	61.32	0.97	0.01	0.10	7.59	3.34	83.48	18.16
4 - Concentrate Bulk	55% - 200m	418.13	49.86	8.41	5.26	0.50	2.27	92.54	94.35	18.31	79.54
4 - Concentrate Zn		25.30	0.51	63.69	0.20	0.01	0.01	5.93	2.04	77.82	6.42

Grinding between 60-65% -200m is recommended. Test N°3 shows the best metallurgical behaviour and the Pb grade in the concentrate is 60.70% with a recovery of 92.94% Pb.

### 13.5.6 Flotation Test – 2015

The test program included granulometric analysis, grinding tests and three flotation tests. The head grade of the sample was 4.02% Pb, 15.60 oz /t Ag, 3.98% Zn and 0.38% Cu. Grindability tests indicate that the mineral is of medium hardness.

Flotation tests results are shown in Table 13-13.

Table 13-13: Result of recoveries from flotation tests - 2015, Santa Elena mine

N° Test	Cond.	Concentrate Grade				Recovery			
		Ag (oz/t)	Pb (%)	Zn (%)	Cu (%)	Ag (%)	Pb (%)	Zn (%)	Cu (%)
1 - Concentrate Bulk	60% -200m	210.70	60.28	4.12	5.48	68.81	81.81	8.06	77.25
1 - Concentrate Zn		53.00	2.72	65.73	0.63	21.92	7.67	87.40	12.40
2 - Concentrate Bulk	60% -200m	261.00	66.68	3.87	3.95	64.82	77.36	7.88	49.45
2 - Concentrate Zn		92.00	5.43	60.44	2.87	29.57	12.99	88.31	43.40
3 - Concentrate Bulk	55% -200m	202.20	60.44	4.35	6.03	66.99	84.61	9.47	79.08
3 - Concentrate Zn		72.30	2.13	59.92	0.81	26.77	7.76	86.86	13.82

The table above shows a high-grade lead-silver concentrate with excellent recovery, as well as a high-grade zinc concentrate with excellent metallurgical recovery.

### 13.5.7 Flotation Test – 2021

Four batch flotation tests were performed. The head grade of the sample was 7.88% Pb, 1,729 g/t Ag, 8.53% Zn and 0.82% Cu. The average results of the flotation tests are shown in Table 13-14.

Table 13-14: Result of recoveries from flotation tests - 2021, Santa Elena mine

Product	Concentrate Grade						Global Recovery					
	Ag (g/t)	Pb (%)	Zn (%)	Cu (%)	Sb (%)	As (%)	Ag (%)	Pb (%)	Zn (%)	Cu (%)	Sb (%)	As (%)
Rougher Bulk	9120.00	39.03	22.41	4.44	2.69	0.48	75.80	67.00	37.90	72.20	72.30	55.84
Scv Bulk	5680.00	34.30	22.41	2.36	1.57	0.30	12.00	15.00	9.60	9.80	10.70	8.87
Rougher Zn	1250.00	6.79	44.08	0.80	0.45	0.13	6.20	6.90	44.20	7.70	7.20	8.90
Scv Zn	1221.00	9.09	15.55	1.00	0.51	0.21	1.50	2.20	3.80	2.30	2.00	3.50

The Mineral is amenable to flotation; however, high activation of zinc sulphides was evidenced during flotation of the bulk concentrate. The low zinc recovery is a consequence of the deficiencies that occurred in the flotation of the bulk concentrate. Chapi Metallurgical Laboratory did not use the correct reagents for the high head grade.

The study recommended monitoring of arsenic and antimony in the final concentrates. The following flowsheet was used for flotation testing carried out on the mineralized material samples.

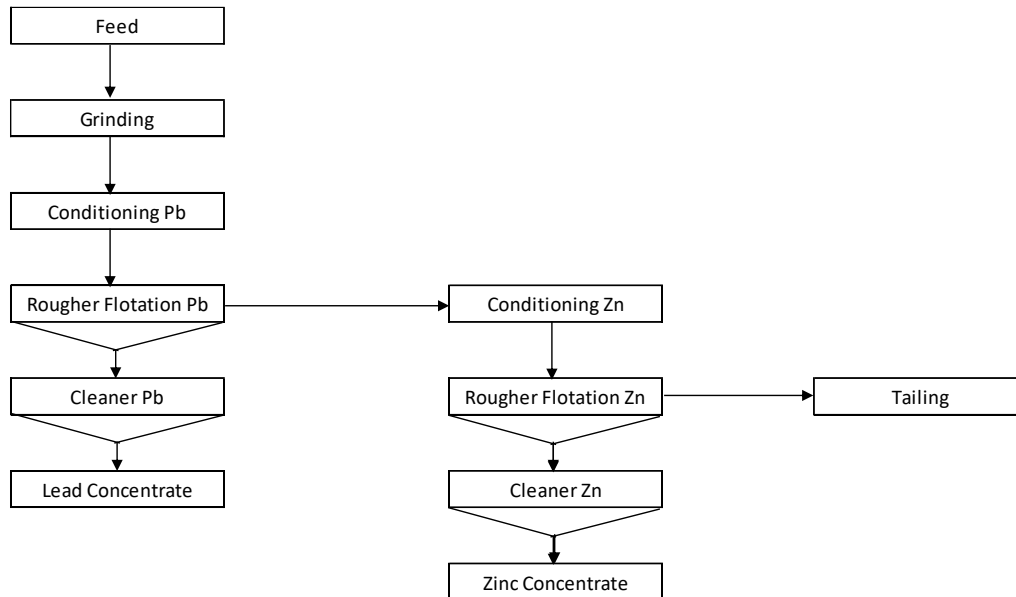

Figure 13-1: Flow Chart for Flotation Test

### 13.6 Concentrate Quality Results

Initial flotation tests reports indicate that arsenic depressant was used to control arsenic content in the concentrate. Arsenic levels of the concentrates range from 0.55% to 0.91% after using the reagent. The presence of arsenic in lead concentrates is due to the presences of copper gray (tetrahedrite, silver bearer).

Then, between 2013 and 2015, campaigns were carried out at industrial level to produce concentrates which were finally traded. There is no information available regarding the trading of these concentrates and whether they were subject to discounts for containing penalized elements.

## 14 MINERAL RESOURCE ESTIMATES

---

### 14.1 Introduction

Caracle Creek was retained by Kuya to prepare a NI 43-101 compliant mineral resource estimate (the “MRE”) supported by a technical report, for the Bethania Silver Project, Peru. The MRE incorporates all current diamond drilling for which the drill hole data could be confidently confirmed. The effective date of the Mineral Resource Estimate is 10 December 2021.

The MRE was prepared under the direction of Co-Author and QP Simon Mortimer, with assistance from Luis Huapaya and Daniel Basilio. The Co-Author developed the geological interpretation and the construction of the lithology model and the mineralised domain models, Luis Huapaya completed the work on the statistics, geo-statistics and the grade interpolation, and Daniel Basilio assisted in the compilation of data and reporting.

The deposit type being considered for silver and gold mineralization discovered to date on the Bethania Silver Project is that of a polymetallic (Ag-Pb-Zn-Cu-Au) hydrothermal deposit whose mineralogy, mineralization, textures, and associated alteration phases are consistent with the intermediate sulphidation epithermal (ISE) geological model for volcanic-hosted precious metal deposits (see Figure 8-1).

The MRE contained in the Report were developed in accordance with “CIM Definition Standards for Mineral Resources and Reserves” prepared by the CIM Standing Committee on Resource Definitions and adopted by the CIM council on 19 May 2014 (CIM, 2014).

### 14.2 Resource Database

The information used for the mineral resource estimate is derived from the Kuya 2021 drill campaign, and from underground channel sample data compiled as historical data by Kuya Silver prior to the release of the Technical Report in 2019.

#### 14.2.1 Drilling Database

Kuya Silver carried out a Phase 1 diamond drilling campaign from March 2021 to April 2021 completing 36 diamond drill holes, drilling a total of 4,988 m. All drilling and sampling data has been verified, validated, and imported into a Geobank™ cloud-based data management system, including data and meta-data on the collar, survey, geological logging tables (Lithological, Alteration, Structural, Mineralization), geotechnical (Recovery, Density), and assay sample data. Information from 33 of the 36 drill holes were used in the resource, a total of 4,405.65 m of drill core information including 3,121 samples, using analyses of Au, Ag, Pb, Cu and Zn in the resource calculation. There are no previous drilling campaigns completed on the Project.



#### ***14.2.2 Collar Location and Downhole Deviation***

All of the 36 drill hole collar locations were positioned using a handheld GPS and then later measured again using a Total station LEICA TS02 Power 5", with an accuracy of 2 millimetres. The downhole deviation of all the drill holes have been measured using Devico's multi-shot gyro survey instrument, DeviGyro™ taking readings approximately every 5 meters.

#### ***14.2.3 Historical Data***

In 2013 and 2014 the Bethania mine was operated by Andes Export SAC, and the during production a total of 608 grade control channel samples were taken from the 4640, 4670, 4690 and 4720 mine levels; 295 from the 12 de Mayo vein, 63 from the Victoria vein, 42 from the 12 de Mayo RHW vein, 135 from the Española vein, 20 from the Española RFW vein, 9 from the 12 de Mayo RFW vein, 2 from the Maria RHW vein, 6 from the Betsaida vein, 2 from the Yolanda vein, 2 from the Carolina II vein, and 3 from the Carolina vein.

The channel samples were analysed at external laboratories and were analysed for silver, lead, zinc, and copper, with some samples also being analysed for gold and others for iron. No QA/QC protocols were carried out within the grade control sampling procedures; however, it is recognised that the external laboratories used do run their own protocols to assure a control on the quality of the sample results.

The locations of the channel samples were captured from AutoCAD plans and located correctly in 3D space through a survey of the mine workings carried out in late 2020 by Cima Nevada using a Total Station. Due to safety reasons only 20% of the interior of the mine could be accessed and surveyed, the location of the rest of the mine workings and the channel samples were correctly positioned relative to the surveyed sections of the mine.

#### ***14.2.4 Assay Sample Summary***

The sample interval lengths are based on geological contacts and vary between 20 cm and 2 meters. The shorter sample lengths were taken across visible veins or visual limits of mineralization while the longer sample lengths, up to a maximum of 2 m were taken from drill core with longer lengths of homogenous mineralization. In total 145 samples were taken from 3,256 m of mineralized drill core. Figure 14-1 details the number of sample interval lengths that were taken during the 2021 drilling campaign.

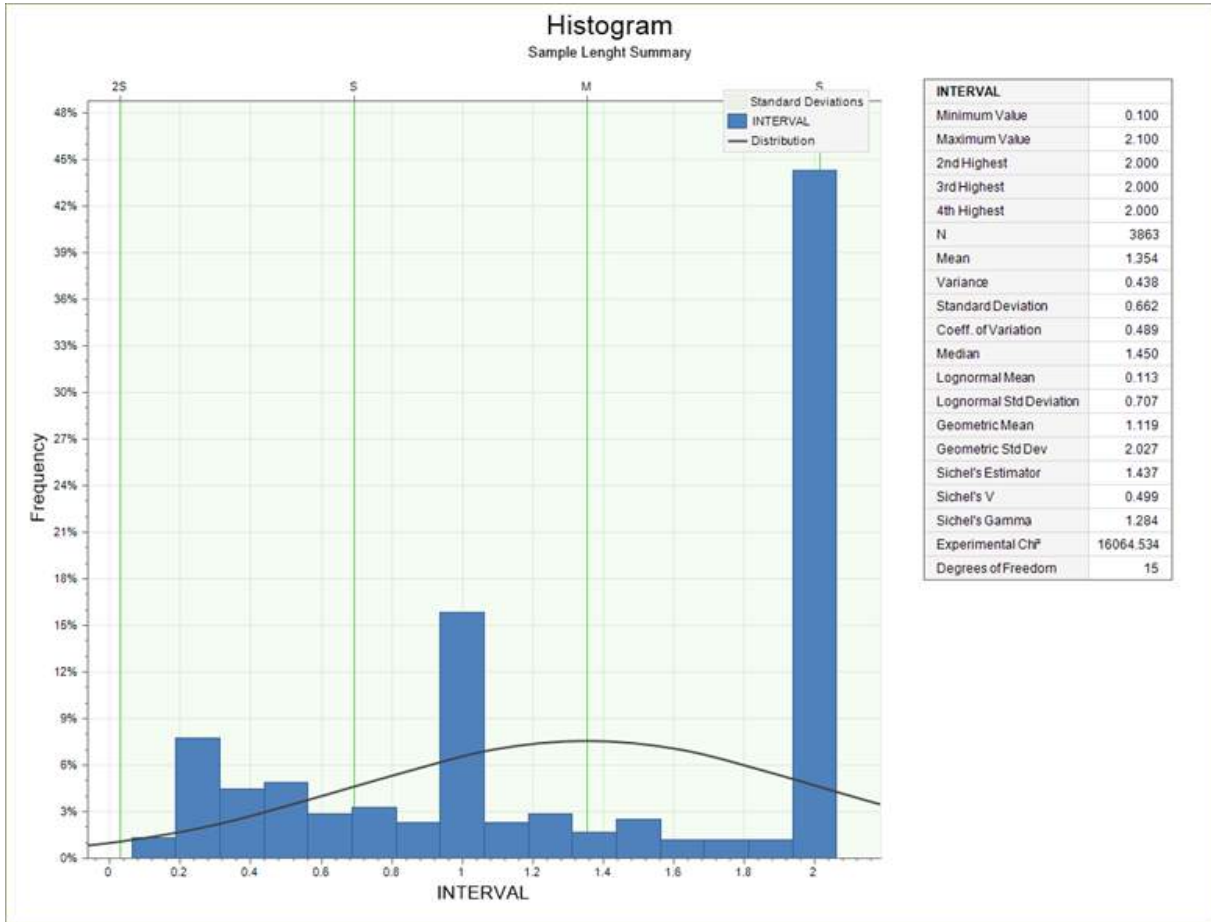

Figure 14-1: Summary of drill hole core sampled, Phase 1 drilling, Bethania Silver Project

### 14.3 Estimation Methodology

The resource model considers only the Mine Zone region of the Santa Elena concession. The Hilltop Zone has been mapped, drilled, and subsequently modelled, however there is insufficient data to be able to complete a suitable estimation on the Hilltop Zone veins. Figure 14-2 shows the resource model limits and the veins that have been modelled.

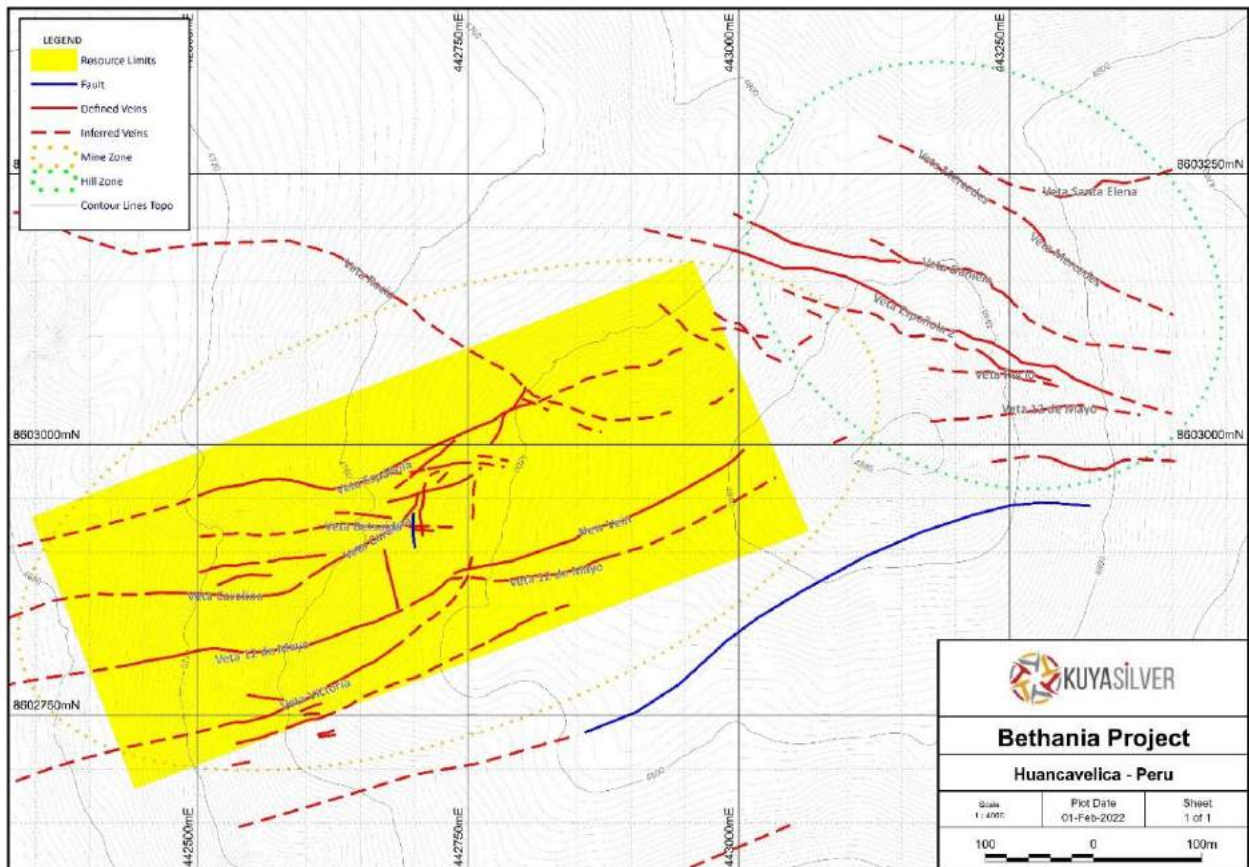

Figure 14-2: Plan map of the Santa Elena concession showing the extent of the current resource model (yellow rectangle)

The estimation of the resource can be broken down into the following stages:

- Validation of the information utilized in the resource and database compilation.
- Interpretation and 3D modeling of the mineralization, based on lithology, alteration, structure, and grade.
- Compositing of grade across the mineralized structures.
- Interpolation of grade within the defined mineralization boundaries.
- Evaluation of confidence in the estimation.
- Model validation.

The validation of the data and database compilation was completed using the GeobankTM data management software. The interpretation and 3D geological modeling was completed using the Leapfrog GeoTM software, statistical studies were performed using MicromineTM tools, the block model, subsequent estimation, and validation was carried out using MicromineTM 2021 software.

#### 14.4 Geological Interpretation and Modelling

The interpretation of the geology used structural, lithological and alteration data from surface geological mapping, from the existing mine level plans and from the drill hole logging. The

interpretation was continually adjusted as the three-dimensional geological models were built, as the location, orientation and dip of the individual veins and veins sets would be adjusted to fit all data. Continual revision in both section and plan in 25 m increments has led to the creation a very robust 3D interpretation of the mineralised structures (Figure 14-3).

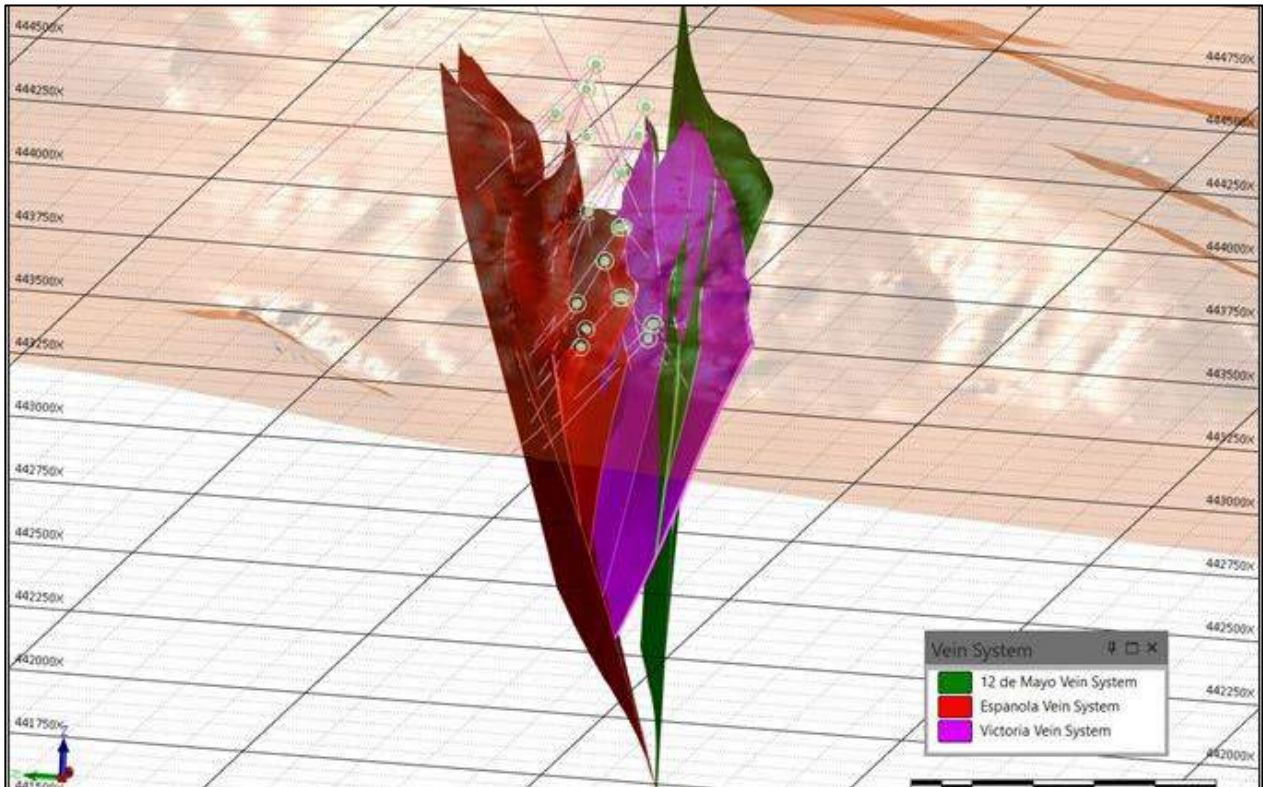

Figure 14-3: Isometric view of the Bethania vein model, showing the 3 principal vein systems

The geological modelling involved the creation of a lithology model, a structural model, an alteration model, and a mineralisation model. The lithology model was based primarily on the geological logging of the diamond drill holes with additional information extracted from surface mapping, however the intense argillic alteration seen at the surface within the Mine Zone obfuscated the original rock mineralogy making it difficult to determine the rock type. Where conflicting lithology types were noted between the geological mapping and the drill core, the data in the drill core was used in preference.

The area comprises volcanic sequences with a monzonitic intrusion at the centre of the Mine Zone. The monzonite appears to be heterogenous, with some regions exhibiting low grade non-economic copper mineralisation and a variable amounts of associated quartz veining. It is probable that there are various phases of intrusions, however further work is required to determine this. The region that was previously interpreted as stockwork within volcanics, is now recognised as porphyritic monzonite with associated quartz veining.

The geological logging included the defined recording of faults measuring of their orientations, which were mapped as surfaces with known dip and dip-direction. Only notable faults surfaces were modelled when they could be traced through several drill intercepts. The



three principal veins, Española, 12 de Mayo and Victoria, all have associated faults running along their base; however, it is only across the Victoria vein/fault that any displacement could be measured. The vertical fault running approximately east-west through the middle of the concession in the previous interpretations could not be recognised in the drill cores and has now been taken out of the model.

The alteration data recorded in the geological logging outlined regions of potassic alteration, an overprinting argillic alteration, more dominant and intense towards the surface sometimes destroying the original rock texture, and more distal to the monzonite intrusion a propylitic zone. The alteration zones although important for the rock quality designation it was found not to be in the was not to have any bearing on the mineralisation. Figure 14-4 is a cross section of the alteration assemblages across the centre of the mine zone.

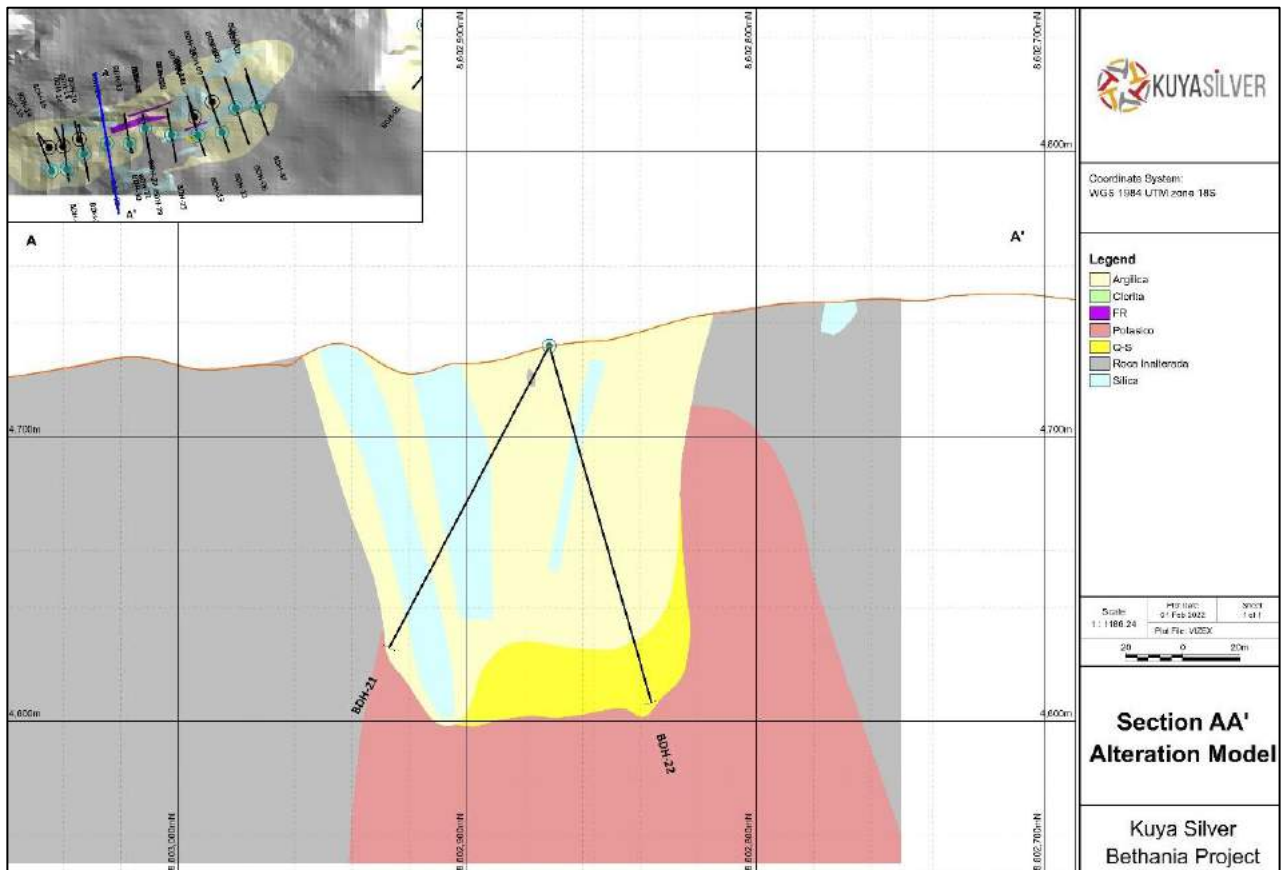

Figure 14-4: Example cross-section through the Bethania showing the alteration model

The mineralisation recorded in the geological logging of the diamond drill core focused on the mineral content of the vein material, but also mapping the mineral content of the porphyry intrusion(s) and pyrite content seen within the volcanics. The vein contains the massive sulphides of between 20% to 80% comprising galena, sphalerite, pyrite, and silver sulpho-salts with barite and carbonate as the principal gangue minerals.

A review of the assay results against the logged mineralisation found that not only the vein material carries high grade mineralisation, but drill core on either side of the vein and that

certain faults and fractures also carries silver-lead-zinc mineralization albeit not high grade. A review of the distribution of gold, silver, lead, copper and zinc assays alongside the logged lithology and mineralogy indicates that the veins open and close along strike but that the mineralisation continues as a narrow zone along the structures.

The mineralised material consists of vein, mineralised footwall and hanging wall and the associated mineralised structures. The definition of the mineralised intervals and the subsequent estimation domain model is based entirely on assay data.

The modelling of the mineralisation used the vein modeling tools within the Leapfrog GeoTM software, defining the footwall and hanging wall directly from the drill hole intervals considered as mineralised and interpolating between the drill contact points using a surface for footwall and a separate surface for the hanging wall, constrained by the drill and channel sample data. This methodology gives a more representative model of the vein thickness and enables the modeller to test multiple interpretations. No cut-off was used to define the limits extent of mineralisation in the drill core as the break between high grade and no grade is well marked.

## 14.5 Data Analysis and Estimation Domains

### 14.5.1 Exploratory Data Analysis (EDA)

The geological modelling of the estimation domains considered mineralisation from vein, mineralised structures, and mineralised footwall and hanging wall. The statistical analysis was completed on the sample data points that are contained within the mineralised domain wireframes, considering both channel sample data and drill holes samples. Table 14-1 shows the summary statistics for the mineralised structures modelled in the Bethania mine zone.

*Table 14-1: Summary of the basic statistics for all data points within the mineralised structures at Bethania*

Metal	Min	Max	N° Samples	Mean	Var	Stnd Dev.	Coef.Var	25 Prcntl	50 Prcntl	75 Prcntl
Au_GPT	0.016	6.33	145	0.50	0.57	0.75	1.51	0.12	0.24	0.55
Ag_OZT	0.006	180.40	724	17.05	381.47	19.53	1.15	3.15	10.93	23.81
Pb_PCT	0.002	39.50	724	4.62	32.60	5.71	1.23	0.69	2.85	6.24
Zn_PCT	0.007	19.90	724	2.84	10.24	3.20	1.13	0.56	1.70	3.90
Cu_PCT	0.000	6.68	724	0.25	0.21	0.46	1.86	0.01	0.10	0.33

The number of sample data point for gold is notably less than the other metals as no gold analysis was taken in the historic channel samples and the 145 samples are the data points from the recent drilling campaign.

The basic statistical evaluation shows the highly variable nature of the polymetallic grades within the mineralised structures, which is expected within this type of system where the vein



is known to open and close along strike, creating shoots of high-grade material alongside lower grade material. To further analyse the distribution of mineral throughout the mine zone, the statistical analysis was broken down into the individual mineralised structures and separated the channel and drillhole data samples. Table 14-2, Table 14-3 and Table 14-4 show the summary statistics for the individual mineralised structures of the Victoria vein set, the 12 de Mayo vein set, and the Española vein set, respectively.

*Table 14-2 : Summary statistics for the Victoria veins sets, grouped by individual mineralised structures (Domain)*

Metal	Domain	Min	Max	N° Samples	Mean	Var	Stnd Dev.	Coef.Var	25 Prcntl	50 Prcntl	75 Prcntl
Au_GPT	Victoria	0.12	6.33	15	1.03	2.35	1.53	1.48	0.25	0.44	1.16
Ag_OZT	Victoria	0.33	72.72	78	20.94	312.50	17.68	0.84	6.19	15.97	33.00
Cu_PCT	Victoria	0.00	2.14	78	0.39	0.21	0.46	1.16	0.04	0.25	0.65
Zn_PCT	Victoria	0.05	16.80	78	4.31	14.31	3.78	0.88	1.65	3.03	5.86
Pb_PCT	Victoria	0.06	28.10	78	5.58	32.37	5.69	1.02	0.65	4.07	8.38
Au_GPT	Yolanda_P	0.10	1.54	12	0.55	0.30	0.54	0.99	0.14	0.39	0.66
Ag_OZT	Yolanda_P	0.04	21.17	14	4.61	56.06	7.49	1.62	0.27	0.94	4.70
Cu_PCT	Yolanda_P	0.01	0.21	14	0.07	0.00	0.06	0.94	0.02	0.05	0.08
Zn_PCT	Yolanda_P	0.01	4.70	14	0.85	1.52	1.23	1.44	0.14	0.43	1.24
Pb_PCT	Yolanda_P	0.00	16.60	14	3.10	30.55	5.53	1.78	0.08	0.26	3.47

The difference in the number of samples in domains such as 12 de Mayo, 12 de Mayo RFW, 12 de Mayo RHW, Betsaida, Carolina, Carolina P, Espanola RFW, Espanola, Maria RHW1, Victoria and Yolanda are because the channel samples were not analyzed for gold. For these domains, the resource estimation only considers data obtained from the drilling campaign.

*Table 14-3: Summary statistics for the 12 de Mayo vein sets, grouped by individual mineralised structure (Domain)*

Metal	Domain	Min	Max	N° Samples	Mean	Var	Stnd Dev.	Coef.Var	25 Prcntl	50 Prcntl	75 Prcntl
Au_GPT	12Mayo_P	0.08	0.86	7	0.28	0.07	0.26	0.94	0.15	0.20	0.26
Ag_OZT	12Mayo_P	0.47	128.78	56	28.22	635.42	25.21	0.89	10.93	21.70	35.49
Cu_PCT	12Mayo_P	0.00	1.37	56	0.26	0.08	0.28	1.06	0.05	0.20	0.34
Zn_PCT	12Mayo_P	0.14	15.50	56	4.05	11.32	3.36	0.83	1.70	3.35	5.62
Pb_PCT	12Mayo_P	0.05	39.50	56	11.21	106.64	10.33	0.92	3.15	8.27	15.05
Au_GPT	12Mayo_P_	0.17	0.46	5	0.27	0.02	0.12	0.45	0.20	0.20	0.35
Ag_OZT	12Mayo_P_	0.16	124.50	251	14.26	180.31	13.43	0.94	5.48	10.70	19.89
Cu_PCT	12Mayo_P_	0.00	6.08	251	0.19	0.23	0.48	2.56	0.00	0.07	0.18
Zn_PCT	12Mayo_P_	0.07	11.90	251	2.21	3.72	1.93	0.87	0.76	1.59	3.16
Pb_PCT	12Mayo_P_	0.09	28.30	251	4.18	17.84	4.22	1.01	1.28	2.96	5.68
Au_GPT	12Mayo_RFW	0.13	2.50	7	0.66	0.77	0.88	1.32	0.16	0.23	0.74
Ag_OZT	12Mayo_RFW	0.03	93.17	16	23.24	737.73	27.16	1.17	2.17	12.38	30.36
Cu_PCT	12Mayo_RFW	0.00	1.25	16	0.35	0.15	0.39	1.10	0.06	0.19	0.51
Zn_PCT	12Mayo_RFW	0.02	14.30	16	3.10	14.41	3.8	1.22	0.15	1.76	4.18
Pb_PCT	12Mayo_RFW	0.00	23.50	16	5.86	46.68	6.83	1.17	0.47	3.38	8.32
Au_GPT	12Mayo_RFW1	0.07	0.07	2	0.07	0.00	0	0.01	0.07	0.07	0.07
Ag_OZT	12Mayo_RFW1	0.60	1.49	2	1.04	0.40	0.63	0.61	0.82	1.04	1.27
Cu_PCT	12Mayo_RFW1	0.01	0.02	2	0.01	0.00	0.01	0.67	0.01	0.01	0.02

Metal	Domain	Min	Max	N° Samples	Mean	Var	Std Dev.	Coef.Var	25 Prcntl	50 Prcntl	75 Prcntl
Zn_PCT	12Mayo_RFW1	0.06	0.08	2	0.07	0.00	0.01	0.18	0.06	0.07	0.07
Pb_PCT	12Mayo_RFW1	0.05	0.49	2	0.27	0.10	0.31	1.15	0.16	0.27	0.38
Au_GPT	12Mayo_RHW	0.06	0.27	7	0.16	0.01	0.08	0.51	0.10	0.17	0.23
Ag_OZT	12Mayo_RHW	0.08	98.87	49	22.35	349.76	18.7	0.84	10.61	17.68	30.87
Cu_PCT	12Mayo_RHW	0.01	0.88	49	0.32	0.05	0.22	0.69	0.15	0.28	0.45
Zn_PCT	12Mayo_RHW	0.07	5.95	49	1.67	1.98	1.41	0.84	0.58	1.35	2.15
Pb_PCT	12Mayo_RHW	0.02	25.30	49	7.17	30.77	5.55	0.77	2.90	6.20	10.50
Au_GPT	NV_P	0.24	0.98	4	0.50	0.11	0.33	0.66	0.29	0.40	0.61
Ag_OZT	NV_P	0.22	10.64	4	3.22	24.89	4.99	1.55	0.33	1.01	3.91
Cu_PCT	NV_P	0.07	0.77	4	0.25	0.12	0.34	1.35	0.08	0.09	0.26
Zn_PCT	NV_P	0.07	3.63	4	1.08	2.91	1.71	1.58	0.23	0.31	1.17

Table 14-4: Summary statistics for the Española vein sets, grouped by individual mineralised structure (Domain)

Metal	Domain	Min	Max	N° Samples	Mean	Var	Std Dev.	Coef. Var	25 Prcntl	50 Prcntl	75 Prcntl
Au_GPT	Betsaida_P	0.08	1.22	15	0.39	0.11	0.34	0.86	0.12	0.27	0.59
Ag_OZT	Betsaida_P	0.05	14.39	21	2.56	17.32	4.16	1.63	0.27	0.88	2.97
Cu_PCT	Betsaida_P	0.00	0.58	21	0.14	0.03	0.18	1.31	0.02	0.07	0.17
Zn_PCT	Betsaida_P	0.03	18.95	21	1.68	16.75	4.09	2.43	0.14	0.41	1.73
Pb_PCT	Betsaida_P	0.01	3.00	21	0.72	0.79	0.89	1.23	0.07	0.20	1.48
Au_GPT	Carolina II	0.07	3.45	9	0.83	1.22	1.1	1.33	0.13	0.33	1.30
Ag_OZT	Carolina II	0.15	49.30	11	7.74	212.65	14.58	1.88	0.97	1.79	7.14
Cu_PCT	Carolina II	0.02	0.63	11	0.13	0.03	0.18	1.40	0.03	0.03	0.15
Zn_PCT	Carolina II	0.01	14.30	11	1.96	17.52	4.19	2.13	0.24	0.53	1.12
Pb_PCT	Carolina II	0.01	5.17	11	1.07	2.32	1.52	1.43	0.11	0.69	1.23
Au_GPT	Carolina_P	0.02	0.72	10	0.23	0.05	0.22	0.97	0.08	0.16	0.31
Ag_OZT	Carolina_P	0.03	51.28	13	8.80	232.46	15.25	1.73	0.29	0.78	6.74
Cu_PCT	Carolina_P	0.01	0.75	13	0.14	0.04	0.21	1.49	0.04	0.05	0.16
Zn_PCT	Carolina_P	0.01	1.55	13	0.40	0.20	0.45	1.11	0.04	0.23	0.55
Pb_PCT	Carolina_P	0.00	24.20	13	4.38	57.81	7.6	1.74	0.02	0.35	5.75
Au_GPT	Carolina_RFW	0.05	0.15	4	0.09	0.00	0.04	0.46	0.07	0.09	0.11
Ag_OZT	Carolina_RFW	0.01	0.35	4	0.19	0.02	0.15	0.78	0.11	0.21	0.30
Cu_PCT	Carolina_RFW	0.00	0.00	4	0.00	0.00	0	0.22	0.00	0.00	0.00
Zn_PCT	Carolina_RFW	0.02	0.61	4	0.27	0.06	0.25	0.92	0.13	0.23	0.38
Pb_PCT	Carolina_RFW	0.00	0.13	4	0.09	0.00	0.06	0.66	0.08	0.12	0.13
Au_GPT	Espanola_P	0.02	3.20	30	0.62	0.55	0.74	1.20	0.15	0.28	0.84

Metal	Domain	Min	Max	N° Sampl es	Mean	Var	Std Dev.	Coef.Va r	25 Prcntl	50 Prcntl	75 Prcntl
Ag_OZ T	Espanola_P	0.02	104.80	165	17.1 6	432.01	20.78	1.21	1.45	9.43	24.54
Cu_PCT	Espanola_P	0.00	6.68	165	0.26	0.35	0.59	2.28	0.01	0.06	0.32
Zn_PCT	Espanola_P	0.04	19.90	165	3.41	14.72	3.84	1.13	0.43	2.14	4.74
Pb_PCT	Espanola_P	0.01	22.10	165	2.94	15.29	3.91	1.33	0.25	1.40	4.39
Au_GP T	Espanola_RF W	0.04	0.32	6	0.13	0.01	0.11	0.81	0.06	0.10	0.17
Ag_OZ T	Espanola_RF W	0.02	180.40	26	31.2 9	1404.7 9	37.48	1.20	6.82	25.2 7	37.55
Cu_PCT	Espanola_RF W	0.00	1.62	26	0.46	0.19	0.43	0.94	0.10	0.34	0.60
Zn_PCT	Espanola_RF W	0.04	15.30	26	4.90	22.11	4.7	0.96	0.72	3.48	7.65
Pb_PCT	Espanola_RF W	0.00	14.30	26	4.60	16.31	4.04	0.88	1.40	3.71	7.29
Au_GP T	Maria_P	0.02	1.54	7	0.29	0.31	0.55	1.90	0.05	0.07	0.15
Ag_OZ T	Maria_P	0.08	12.80	7	3.86	30.28	5.5	1.43	0.50	0.98	6.07
Cu_PCT	Maria_P	0.00	0.13	7	0.04	0.00	0.05	1.24	0.01	0.01	0.08
Zn_PCT	Maria_P	0.12	7.56	7	1.92	7.41	2.72	1.42	0.28	0.38	2.41
Pb_PCT	Maria_P	0.09	10.87	7	3.03	20.34	4.51	1.49	0.27	0.75	4.46
Au_GP T	Maria_RHW	0.19	0.27	2	0.23	0.00	0.06	0.24	0.21	0.23	0.25
Ag_OZ T	Maria_RHW	2.20	52.01	2	27.1 0	1240.5 5	35.22	1.30	14.65	27.1 0	39.56
Cu_PCT	Maria_RHW	0.03	0.44	2	0.24	0.08	0.29	1.22	0.13	0.24	0.34
Zn_PCT	Maria_RHW	0.56	7.54	2	4.05	24.36	4.94	1.22	2.30	4.05	5.79
Pb_PCT	Maria_RHW	1.55	21.00	2	11.2 7	189.19	13.75	1.22	6.41	11.2 7	16.14
Au_GP T	Maria_RHW 1	0.03	0.03	1	0.03				0.03	0.03	0.03
Ag_OZ T	Maria_RHW 1	1.24	8.97	3	5.67	15.88	3.98	0.70	4.02	6.79	7.88
Cu_PCT	Maria_RHW 1	0.04	0.82	3	0.37	0.16	0.4	1.09	0.14	0.25	0.54
Zn_PCT	Maria_RHW 1	0.14	6.63	3	2.93	11.15	3.34	1.14	1.08	2.03	4.33
Pb_PCT	Maria_RHW 1	0.02	1.95	3	0.80	1.04	1.02	1.28	0.22	0.42	1.19

Table 14-5 shows the summary statistics for the principal veins grouped by sample type, analyzing the difference between the channel samples and the drill hole samples. The variance increases considerably when considering the channel samples, indicating that many of the data points within each domain is required to accurately predict the grade distribution.

Table 14-5: Summary statistics of assay data, grouped by structure and by sample type. Only the three principal structures have been considered

Metal	Domain	Min	Max	N° Samples	Mean	Var	Std Dev.	Coef.Var	25 Prcntl	50 Prcntl	75 Prcntl
Au_GPT	12Mayo_P	0.08	0.86	7	0.28	0.07	0.26	0.94	0.15	0.20	0.26
Ag_OZT	12Mayo_P	0.47	128.78	56	28.22	635.42	25.21	0.89	10.93	21.70	35.49
Cu_PCT	12Mayo_P	0.00	1.37	56	0.26	0.08	0.28	1.06	0.05	0.20	0.34
Zn_PCT	12Mayo_P	0.14	15.50	56	4.05	11.32	3.36	0.83	1.70	3.35	5.62
Pb_PCT	12Mayo_P	0.05	39.50	56	11.21	106.64	10.33	0.92	3.15	8.27	15.05
Au_GPT	12Mayo_P_	0.17	0.46	5	0.27	0.02	0.12	0.45	0.20	0.20	0.35
Ag_OZT	12Mayo_P_	0.16	124.50	251	14.26	180.31	13.43	0.94	5.48	10.70	19.89
Cu_PCT	12Mayo_P_	0.00	6.08	251	0.19	0.23	0.48	2.56	0.00	0.07	0.18
Zn_PCT	12Mayo_P_	0.07	11.90	251	2.21	3.72	1.93	0.87	0.76	1.59	3.16
Pb_PCT	12Mayo_P_	0.09	28.30	251	4.18	17.84	4.22	1.01	1.28	2.96	5.68
Au_GPT	12Mayo_RFW	0.13	2.50	7	0.66	0.77	0.88	1.32	0.16	0.23	0.74
Ag_OZT	12Mayo_RFW	0.03	93.17	16	23.24	737.73	27.16	1.17	2.17	12.38	30.36
Cu_PCT	12Mayo_RFW	0.00	1.25	16	0.35	0.15	0.39	1.10	0.06	0.19	0.51
Zn_PCT	12Mayo_RFW	0.02	14.30	16	3.10	14.41	3.8	1.22	0.15	1.76	4.18
Pb_PCT	12Mayo_RFW	0.00	23.50	16	5.86	46.68	6.83	1.17	0.47	3.38	8.32
Au_GPT	12Mayo_RFW_1	0.07	0.07	2	0.07	0.00	0	0.01	0.07	0.07	0.07
Ag_OZT	12Mayo_RFW_1	0.60	1.49	2	1.04	0.40	0.63	0.61	0.82	1.04	1.27
Cu_PCT	12Mayo_RFW_1	0.01	0.02	2	0.01	0.00	0.01	0.67	0.01	0.01	0.02
Zn_PCT	12Mayo_RFW_1	0.06	0.08	2	0.07	0.00	0.01	0.18	0.06	0.07	0.07
Pb_PCT	12Mayo_RFW_1	0.05	0.49	2	0.27	0.10	0.31	1.15	0.16	0.27	0.38
Au_GPT	12Mayo_RHW	0.06	0.27	7	0.16	0.01	0.08	0.51	0.10	0.17	0.23
Ag_OZT	12Mayo_RHW	0.08	98.87	49	22.35	349.76	18.7	0.84	10.61	17.68	30.87
Cu_PCT	12Mayo_RHW	0.01	0.88	49	0.32	0.05	0.22	0.69	0.15	0.28	0.45
Zn_PCT	12Mayo_RHW	0.07	5.95	49	1.67	1.98	1.41	0.84	0.58	1.35	2.15
Pb_PCT	12Mayo_RHW	0.02	25.30	49	7.17	30.77	5.55	0.77	2.90	6.20	10.50
Au_GPT	NV_P	0.24	0.98	4	0.50	0.11	0.33	0.66	0.29	0.40	0.61
Ag_OZT	NV_P	0.22	10.64	4	3.22	24.89	4.99	1.55	0.33	1.01	3.91
Cu_PCT	NV_P	0.07	0.77	4	0.25	0.12	0.34	1.35	0.08	0.09	0.26
Zn_PCT	NV_P	0.07	3.63	4	1.08	2.91	1.71	1.58	0.23	0.31	1.17
Pb_PCT	NV_P	0.03	1.88	4	0.72	0.71	0.84	1.16	0.14	0.50	1.08

It is only with the use of the channel samples that variation in grade can be adequately modelled. In the domains that contained little or no channel samples the variance is lower, and the resulting estimation being based almost entirely from drill hole data would be smoothed and might capture the true variability within domain.

#### 14.5.2 Estimation Domains

The exploratory data analysis showed that the mineralisation contained within the modelled mineralised structures has a very sharp contact between high grade material and the zero-

grade material in the footwall and hanging wall. The individual mineralised structures have distinct orientations and exhibit differences in mineral content and average grade, therefore the wireframe solids for each mineralised structure have been considered as separate estimation domains. In total 16 estimation domains, each representing a different mineralised structure, have been modelled and subsequently estimated.

**14.5.3 Contact Analysis, Compositing and Capping**

Visual analysis of the grade distribution indicated a well-defined boundary between mineralised and non-mineralised material. The geological modelling of the estimation domains was based on the assay data grade contact, the following figures (Figure 14-5, Figure 14-6 and Figure 14-7,) shows the statistical analysis of silver lead and zinc the across the contact.

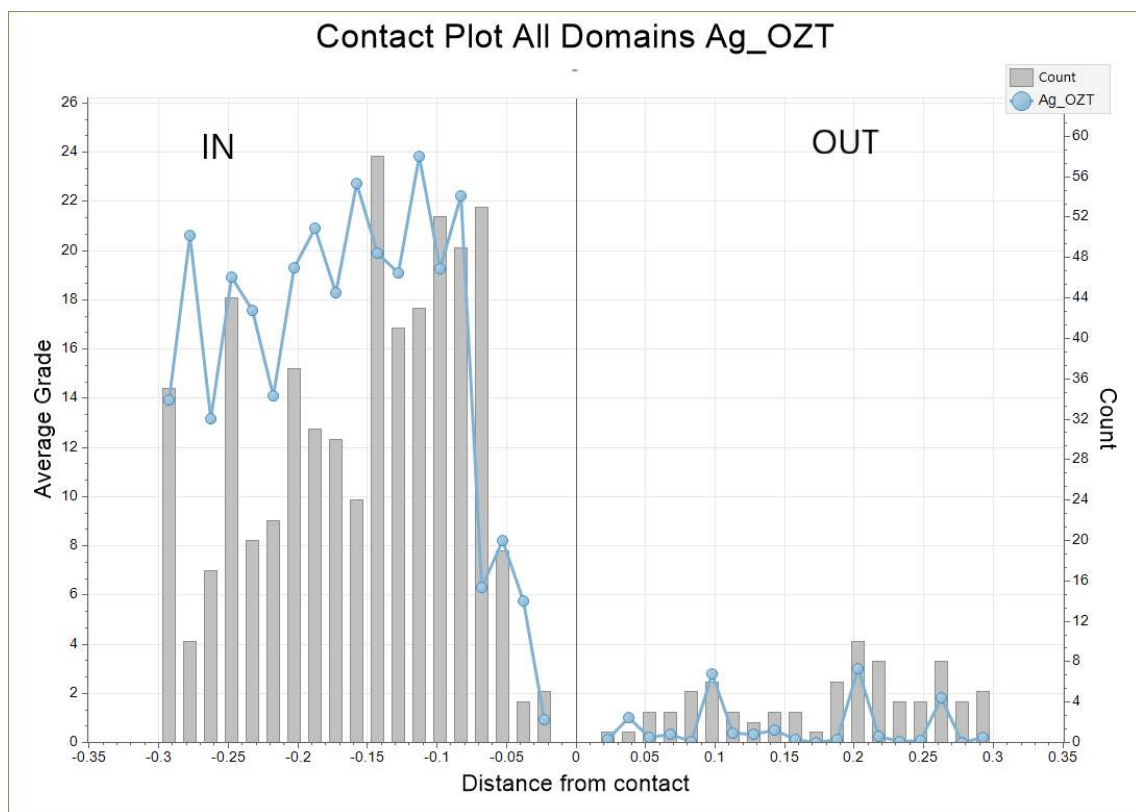

Figure 14-5: Contact analysis plot using data from all modelled veins, showing silver assay statistics (oz/t) for samples inside and outside of the mineralised domains

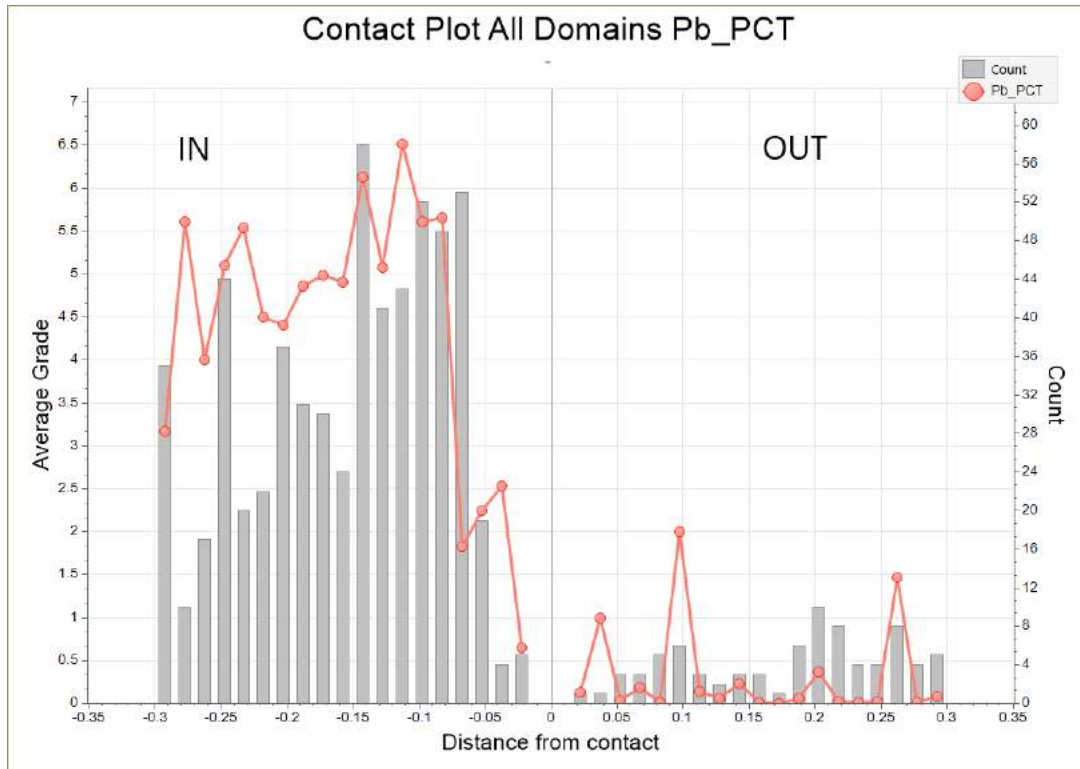

Figure 14-6: Contact analysis plot using data from all modelled veins, showing lead assay statistics (%) for samples inside and outside of the mineralised domains

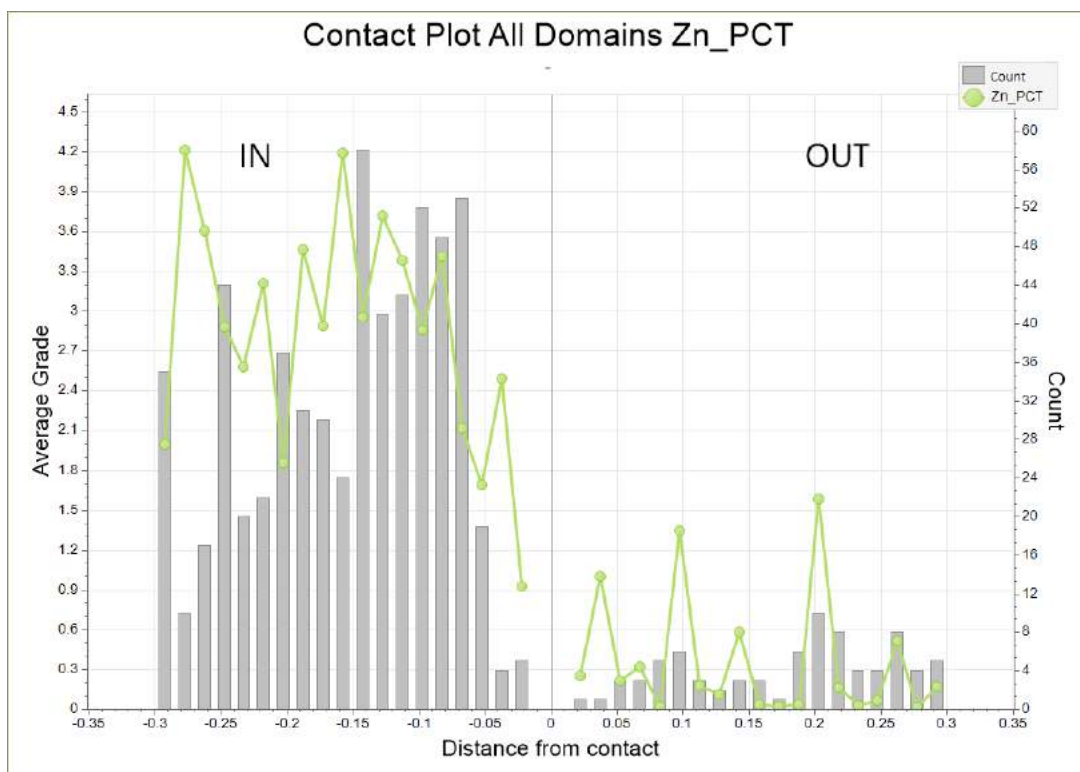

Figure 14-7: Contact analysis plot using data from all modelled veins, showing zinc assay statistics (%) for samples inside and outside of the mineralised domains

The core drilling data was composited based on the coding of the mineralized domains defined from the geological modelling, which included material from veins and mineralised



structures. As the width of the mineral domains are narrow, typically less than one-meter true width, the composite interval lengths were based on the widths of the mineralized domain, generating one composite value for each domain intersection. The definition of the mineralisation domain included, vein material, mineralised structure, and mineralised footwall and hanging wall, the single composite value of the narrow structure is a good representation of the material that would be extracted in a mining operation and would produce a more realistic model in the estimation.

The grade distribution analysis indicated that the modelled domains consider areas of very high and very low grade as the vein opens and closes along strike. The high grades recorded in both the drilling and the channel assay datasets were not considered to be anomalous as they were within the range of the higher-grade material extracted during past mining operation. It was not necessary to cap assay results and no over inflation of high grade occurred in the estimation.

#### 14.6 Specific Gravity

During the geological and geotechnical logging it was not possible to take density samples over the recognized vein material as the sections were typically not of a suitable rock quality to be used for density measurements. After the completion of the drilling campaign and the reporting of the assay data, the mineralised domains were identified and where possible half core samples were taken and sent for specific gravity analysis. As many samples as possible were taken within the mineralised zones, in total 59. The samples were taken from logged vein intervals, zones of mineralized structures and parts of the footwall and hanging wall that contained grade.

A statistical analysis of the results showed two distinct populations, one reflecting material from the mineralised footwall and hanging wall with samples averaging  $2.71 \text{ g/cm}^3$ , and the other reflecting vein material averaging 3.1. Statistical analysis is provided in Figure 14-8. Considering the mineralised domains contain both vein material and the mineralised structures (footwall and hanging wall) the average density of the mineralized domains of  $2.91 \text{ g/cm}^3$  density was used in the resource calculation.

No previous analysis of specific gravity analysis has been made available to the author; however, it is reported that the previous mining operations used a specific gravity value of  $3 \text{ g/cm}^3$  in their tonnage calculations.

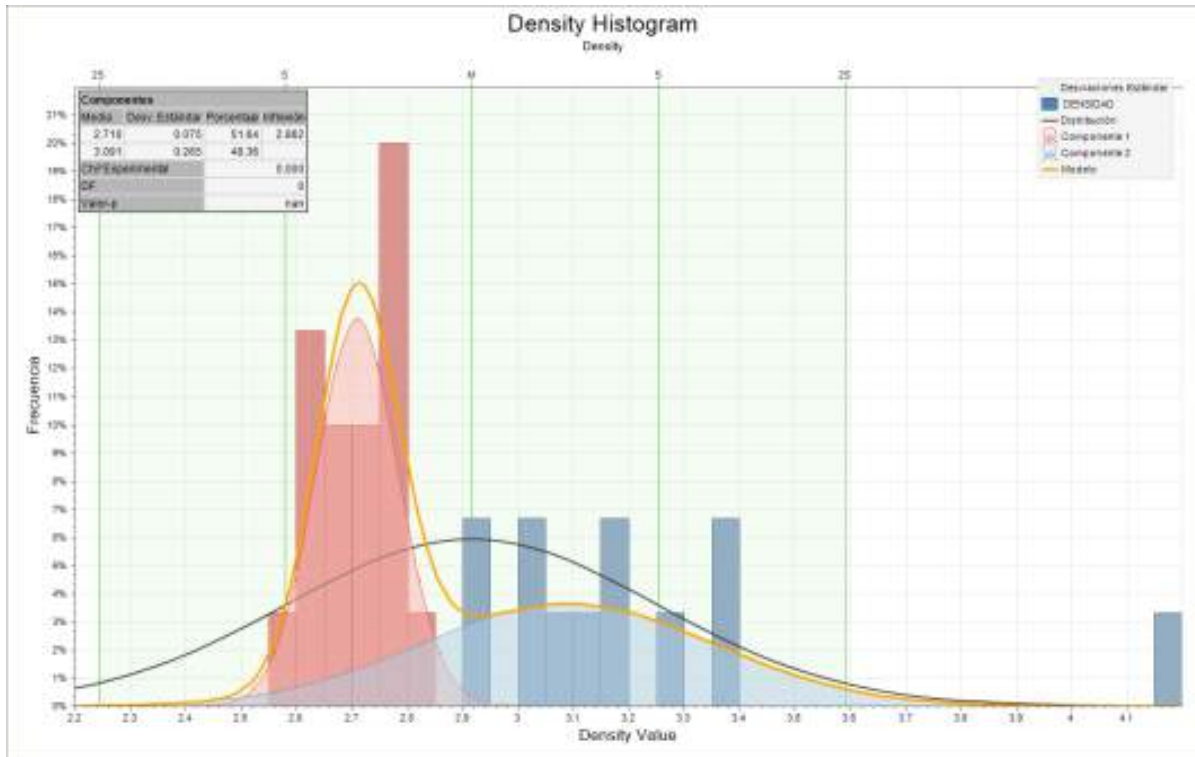

Figure 14-8: Histogram and statistical analysis of specific gravity samples

### 14.7 Block Modelling

To attain a model most representative of the geology and then to apply economic factors to the model, two block models were created; the first, being a sub-blocked model optimised for the geometry of the mineralised structures, then the second a re-block of the first model based on the minimum mining width.

The two block models were built in Micromine software, the dimensions of the first sub-blocked model are 6 m x 1 m x 4 m with sub-blocking of 12, 5 and 8 respectively generating minimum sub-blocks dimensions of 0.5 m x 0.2 m x 0.5 meters. The block model has an orientation of 345 azimuth and is restricted to mineralised domain, with a total of 2,375,659 blocks and sub-blocks.

The regularization of the sub-blocked model was carried out considering the dimensions of the minimum mining width with regular blocks of dimensions 1.0 m x 0.6 m x 1.0 m without sub-blocking, with the same 345 azimuth rotation.

Details of the block model definitions are provided in Table 14-6.

Table 14-6: Parameters of the definition of the block models

Original Block Model (orientation 345 azimuth)				
	Origin Min Centre	Block Size	Factor Sub-Block	Min Block Size
X Coordinate	442122	6.0 m	12	0.5 m
Y Coordinate	8602625	1.0 m	5	0.2 m
Z Coordinate	4298	4.0 m	8	0.5 m
Regularized Block Model (Orientation 345° azimuth)				
	Origin Min Centre	Block Size	Factor Sub-Block	Min Block Size
X Coordinate	442355	1.0 m	-	1.0 m
Y Coordinate	8602722	0.6 m	-	0.6 m
Z Coordinate	4300	1.0 m	-	1.0 m

### 14.8 Variography

Due to the limited amount of data within most of the individual domains, variogram analysis was performed only on the largest domains, those with the most data points from the drilling and channel samples (the Española vein, the 12 de Mayo Vein, and the Victoria vein).

Directional variograms for silver, lead and zinc were produced for each of these domains. The Variogram parameters are provided in Table 14-7.

Table 14-7: Variogram parameters for silver, lead, and zinc

Variogram Parameter for Silver

	Domain	Nugget	Structure				Bering	Plunge	Dip
			Sill	Major	Semi Major	Minor			
Ag_OZT	Espanola	40	278	50	30	20	245	0.3	-65
Ag_OZT	Victoria	33	275	60	50	20	64	0.3	-65
Ag_OZT	12 de Mayo	34	128	60	30	25	84	3	-85

Variogram Parameter for Lead

	Domain	Nugget	Structure				Bering	Plunge	Dip
			Sill	Major	Semi Major	Minor			
Pb_PCT	Espanola	1.09	11.21	72	60	55	245	0.3	-65
Pb_PCT	Victoria	4.65	39.2	120	45	35	64	0.3	-65
Pb_PCT	12 de Mayo	4	12.3	96	89	5	84	3	-85

Variogram Parameter for Zinc

	Domain	Nugget	Structure				Bering	Plunge	Dip
			Sill	Major	Semi Major	Minor			
Zn_PCT	Espanola	1.3	19.34	77	60	43	245	0.3	-65
Zn_PCT	Victoria	1.38	11.89	45	30	5	64	0.3	-65
Zn_PCT	12 de Mayo	0.3	3.44	83	65	7	84	3	-85

The definition of the minor axes was given by the modelled orientations of the mineralized structures, the variograms were modelled in order to determine the plunge orientation of the major axis, which in turn defines the intermediate, and to establish the ranges in the major and intermediate axes and the nugget effect. Only the mineralized domains of 12 de Mayo, Victoria and Española contained enough data points to establish competent variogram models for silver, lead, and zinc. The knowledge gained from the variogram models of the three principal mineralised structures was transferred across and applied to the estimation of the veins with few data points.

## 14.9 Estimation Strategy

### 14.9.1 Estimation Methodology

The estimation of silver, gold, lead, zinc, and copper was carried out using Inverse Distance Weighting (IDW). The estimation was carried out using several passes, applying the following generalized approach:

- The first estimation pass set at 70% of the search ellipse ranges.
- The second estimation pass set at 100% of the search ellipse ranges.
- The third estimation pass set at 200% of the search ellipse ranges.
- The fourth pass using a search ellipse of approximately 300% of the range.

Most of the blocks within each domain were estimated within the first two estimation passes and passes 3 and 4 were used to estimate blocks along the peripheries of the mineralized domains defining those within a lower confidence category.

### 14.9.2 Estimation Parameters

The search ellipse and estimation parameters, all using IDW3, are summarized in Table 14-8. Typically, three passes per domain were sufficient to estimate all the blocks, but due to the quantity and distance between samples in some domains, two passes were used with ranges of greater scope.

*Table 14-8: Summary of search ellipse and estimation parameters.*

Estimation Pass	Domain	Min # of Composites	Max # of Composites	Range		
				Major	Intermediate	Minor
Pass1	Española_P	3	10	60	40	10
Pass2	Española_P	2	7	120	80	20
Pass3	Española_P	2	4	180	120	30
Pass1	12Mayo_P	3	12	60	30	15
Pass2	12Mayo_P	2	10	120	60	30
Pass3	12Mayo_P	2	6	180	90	45
Pass1	12Mayo_P_	3	12	60	30	15
Pass2	12Mayo_P_	2	10	120	60	30
Pass3	12Mayo_P_	2	4	180	90	45

Estimation Pass	Domain	Min # of Composites	Max # of Composites	Range		
				Major	Intermediate	Minor
Pass1	Victoria	5	15	70	40	20
Pass2	Victoria	4	15	140	80	40
Pass3	Victoria	2	4	210	120	60
Pass1	12Mayo_RHW_	3	*	60	30	15
Pass2	12Mayo_RHW_	2	10	120	60	30
Pass3	12Mayo_RHW_	2	4	180	90	45
Pass1	Española_RFW	3	*	60	40	10
Pass2	Española_RFW	2	10	120	80	20
Pass3	Española_RFW	2	4	180	120	30
Pass1	Betsaida_P	3	*	60	40	15
Pass2	Betsaida_P	2	10	120	80	30
Pass3	Betsaida_P	2	4	180	120	45
Pass1	Carolina II	3	*	60	40	15
Pass2	Carolina II	2	5	120	80	30
Pass3	Carolina II	2	4	180	120	45
Pass1	Maria_P	3	*	70	40	20
Pass2	Maria_P	2	5	140	80	40
Pass3	Maria_P	2	4	210	120	60
Pass1	Maria_RHW1	3	*	70	40	20
Pass2	Maria_RHW1	2	2	140	80	40
Pass3	Maria_RHW1	2	4	210	120	60
Pass1	Maria_RHW	2	*	70	40	20
Pass2	Maria_RHW	2	*	140	80	40
Pass3	Maria_RHW	2	4	210	120	60
Pass1	Yolanda_P	3	*	42	28	10
Pass2	Yolanda_P	2	10	120	80	30
Pass3	Yolanda_P	2	4	180	120	45
Pass2	NV_P	3	*	120	80	20
Pass3	NV_P	2	4	180	120	30
Pass1	Carolina_P	3	*	60	40	15
Pass2	Carolina_P	2	4	120	80	30
Pass3	Carolina_P	2	4	180	120	45
Pass2	12Mayo_RHW	2	10	120	60	30
Pass3	12Mayo_RHW	2	4	180	90	45
Pass2	12Mayo_RFW1	2	10	120	60	30
Pass3	12Mayo_RFW1	2	4	180	90	45
Pass2	12Mayo_RFW_	2	10	120	60	30
Pass3	12Mayo_RFW_	2	4	180	90	45
Pass2	Carolina_RFW	2	10	120	60	30
Pass3	Carolina_RFW	2	4	180	90	45
Pass2	12Mayo_RFW	2	10	120	60	30
Pass3	12Mayo_RFW	2	4	180	90	45

\*no maximum number of composites was assigned to these estimation passes; they were set to use all the possible composites that would fall within the ranges used.

Most of the domains were estimated using three passes, the first assigning the blocks that are closer to the input data, the second assigning blocks that are further away and then the third assigning the peripheral blocks within the domain. The domains Española\_P, 12Mayo\_P, 12Mayo\_P\_, Victoria, 12Mayo\_RHW\_, Española\_RFW, Betsaida\_P, Carolina II, Maria\_P, Maria\_RHW1, Maria\_RHW, Yolanda\_P, and Carolina\_P were all estimated with three passes. The other domains, NV\_P, 12Mayo\_RHW, 12Mayo\_RFW1, 12Mayo\_RFW, 12Mayo\_RFW\_, and Carolina\_RFW were estimated on the second and third passes alone as the spacing between the input data points was greater than the range applied in the first pass.

The mineralized structures 12Mayo\_RFW, 12Mayo\_P and 12Mayo\_RHW are crosscut by the Victoria fault and have been displaced by the fault movement, creating two domains per structure. These domains have been modelled separately and are identified in the table as 12Mayo\_RFW & 12Mayo\_RFW\_, 12Mayo\_P & 12Mayo\_P\_, and 12Mayo\_RHW & 12Mayo\_RHW\_.

#### **14.10 Block Model Validation**

The block model estimation has been validated using the following techniques:

1. Visual inspection of the estimated block grades relative to the assay composites.
2. A comparison of the sample composite means with the estimated means from each of the block model domains.
3. A swath plot evaluation of the block model grade profiles in an east-west axis against a nearest neighbour estimation and the assay composites.

##### **14.10.1 Visual Validation**

A detailed visual inspection of the block model was performed both in long section and in plan to ensure that the results obtained in the interpolation are representative of the geology and known grade distribution. The estimated gold, silver, lead, zinc, and copper grades in the model are a valid representation of the sample data taken from the drill holes and channels. Figure 14-9, Figure 14-10 and Figure 14-11 are long sections of the principal mineralised structures, Española, 12 de Mayo and Victoria, respectively. Each figure shows the block model coloured by silver grade and the input data points, both channel samples and the drill hole impacts.

In the visual validation of the Española mineralized structure one can observe the grade variability demonstrated in the channel sample data extending down dip and connecting with the more widely spaced drill holes sample. Laterally towards the eastern edge of the structure the behaviour of the extrapolation is seen to lose range, the blocks in this region fall into a lower confidence category.



A visual validation of the 12 de Mayo vein demonstrates a good correlation between sample data points and the estimated, maintaining variability close to the channel data sample points with smoothing of the estimation towards a local mean further away from the data points.

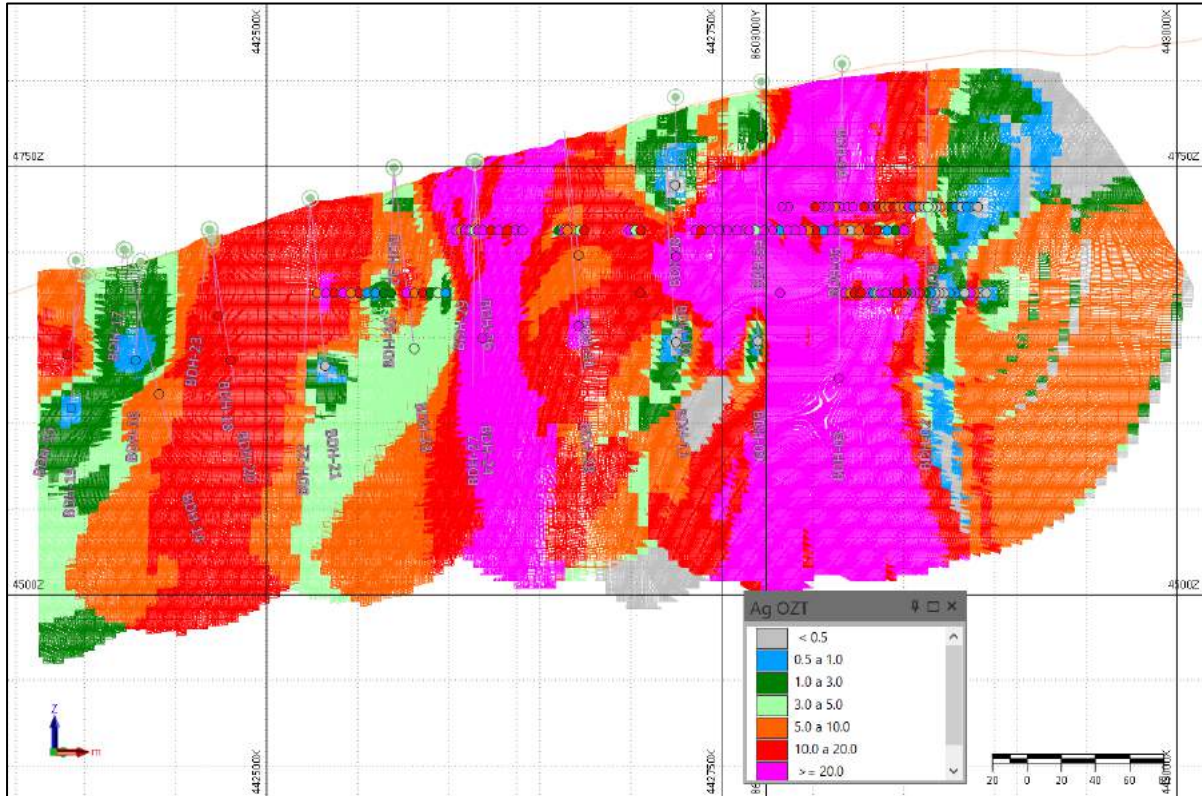

Figure 14-9: Long section of the Espanola Domain looking north

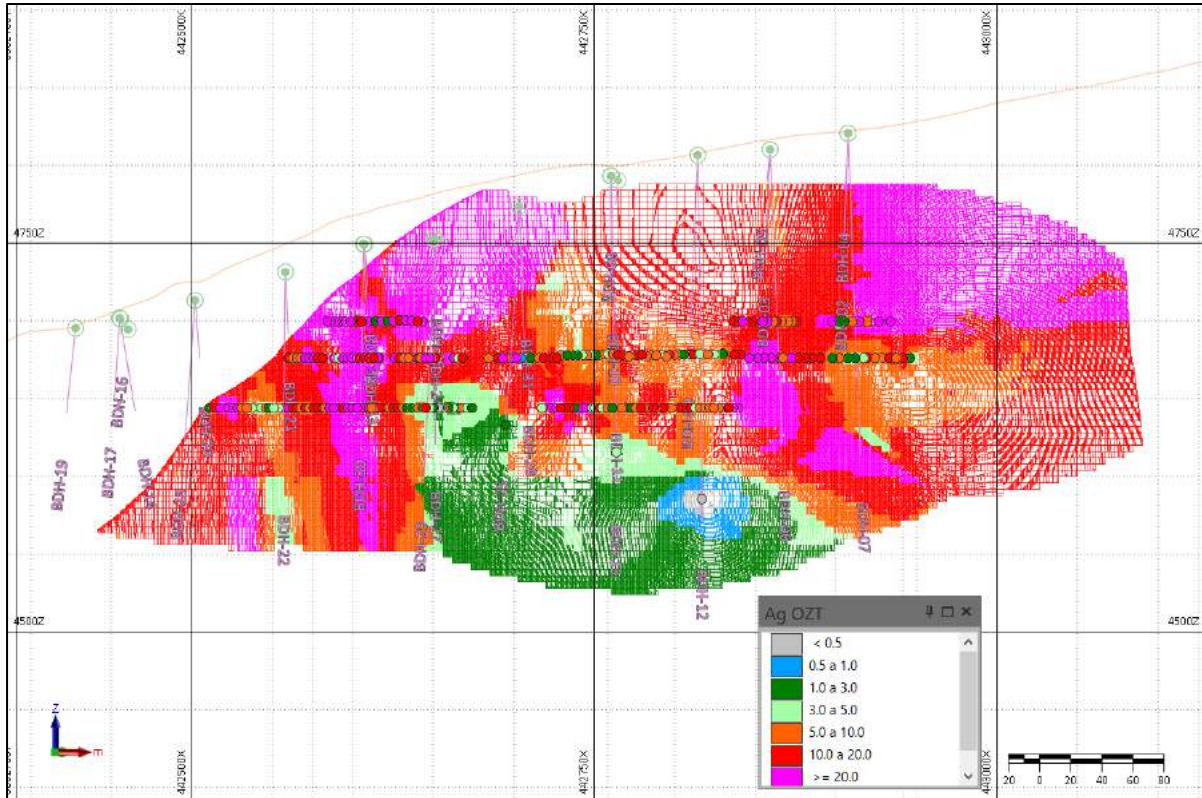

Figure 14-10: Long section of the 12 de Mayo Domain looking north

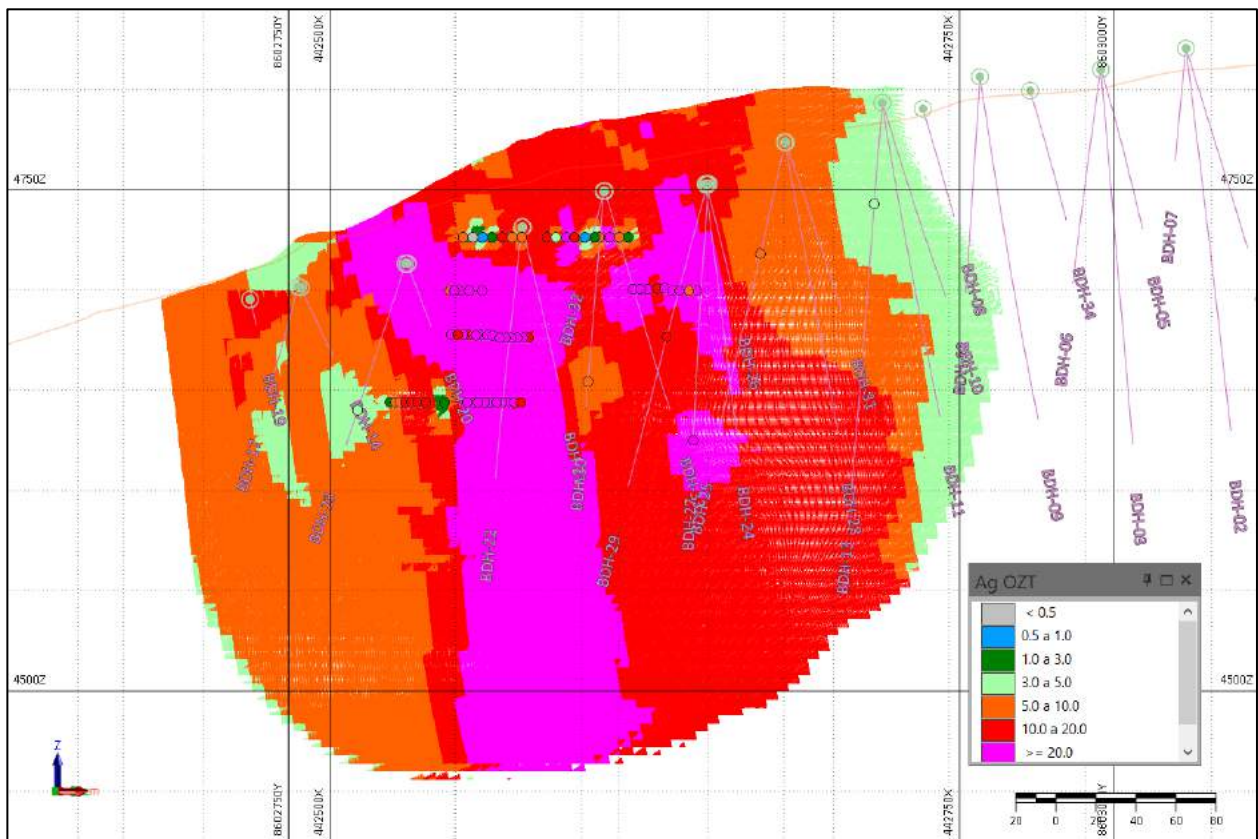

Figure 14-11: Long section of the Victoria Domain looking north

The down-dip extension in the center of the structure is estimated from the drill hole data points, it is possible that this region could contain higher grade material, but the drill hole density was not sufficient to capture the variability.

A visual validation of the block model estimate in the Victoria structure demonstrates how the estimation maintains a reasonable representation of the high-grade shoot within the structure, but however an increase in the input data density at depth is required to map the variability seen in the channel sample of the upper levels.

#### ***14.10.2 Comparison of Means***

A basic analysis of the comparison of the statistics between the estimated results and the input data shows that the estimation does not exhibit any bias and is representative of the samples used in the resource calculation (Table 14-9).

*Table 14-9: Comparison of the statistics between estimated results and input data*

	Mean	
	Estimation Results	Input Data
Au g/t	0.62	0.50
Ag ozt	13.03	17.05
Pb %	3.41	4.62
Zn %	2.46	2.84
Cu %	0.22	0.25

### **14.10.3 Statistical Validation of IDW Estimation Compared with Nearest Neighbour**

The block model was populated with a simple nearest neighbour (NN) estimation and a set of swath plots generated to show how the IDW estimation varies with respect to the NN, and the assay composite values.

The swath plots show graphically how the grade distribution varies from west to east, along strike of the vein sets, plotting the IDW estimated values against the NN estimated values and the assay composite values. Examples for the principal domains, Española, Victoria, and 12 de Mayo are provided in Figure 14-12. In general, there is a good correlation between the drillhole assay data, the nearest neighbor model, and the estimated block grades.

The swath plots for the Española domain demonstrate a good correlation between the IDW and NN estimates, and a good representation of the input data showing no bias, maintaining a local average, and reducing the extremely high and low values to a more local mean.



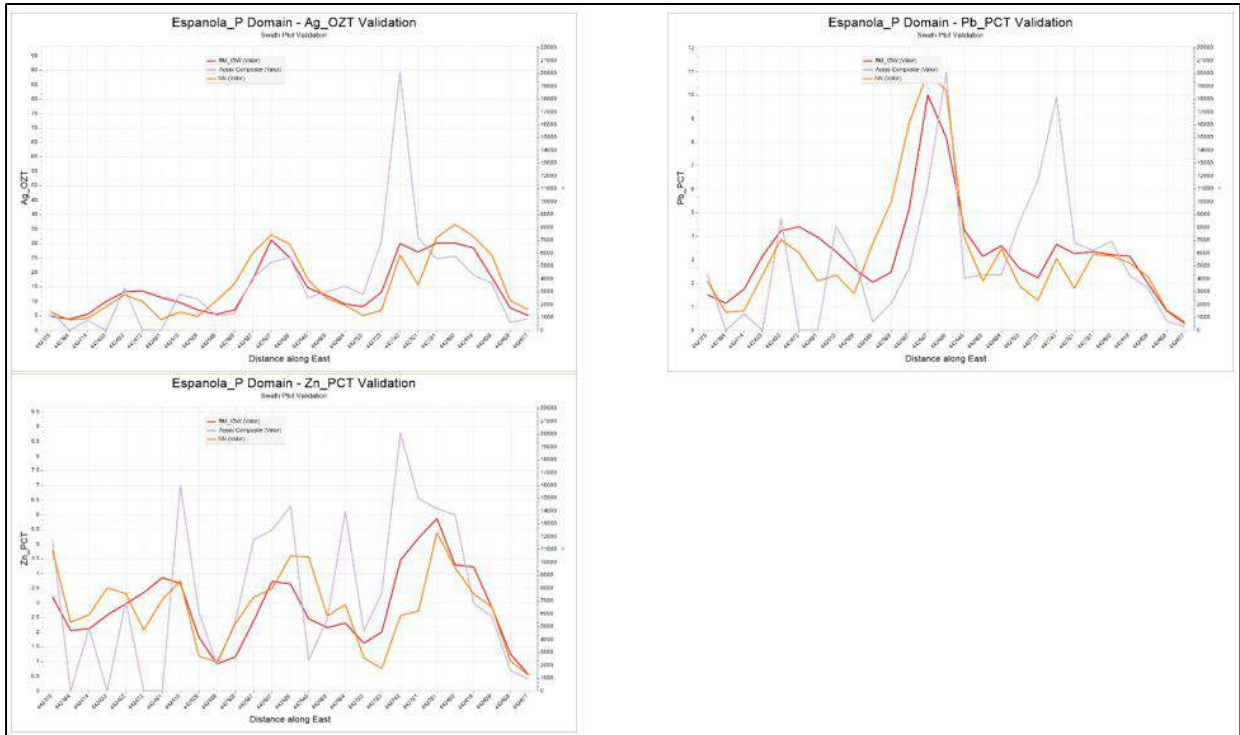

Figure 14-12: Swath Plot validations for the Espanola Domain showing Ag oz/t, Pb% and Zn% grades

The swath plots for the Victoria domain maintain a good correlation with the NN estimation across the entirety of the structure, but further towards the east both the NN and IDW estimates are seen to lose variability and tend towards a smoothed local mean, demonstrating that reduced number of input data points in this region.

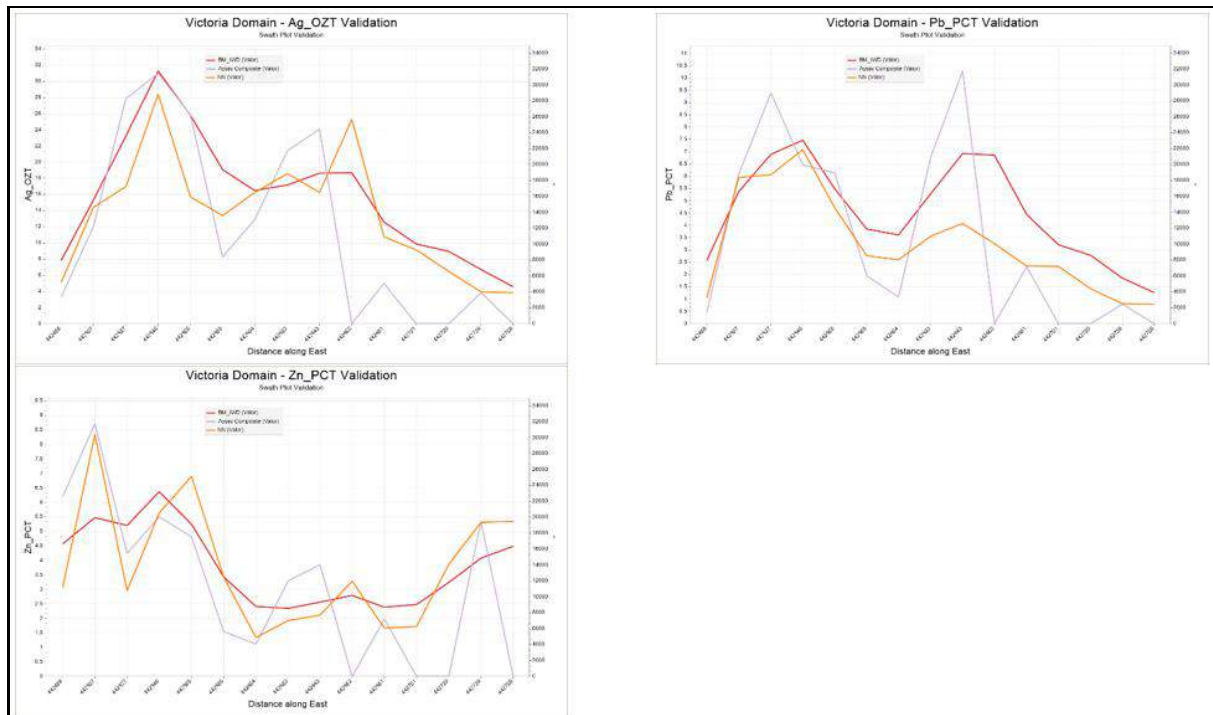

Figure 14-13: Swath Plot validations for the Victoria Domain showing Ag oz/t, Pb% and Zn% grades

The Swath plots for the validation for the 12 de Mayo domain demonstrate a good correlation with the NN and IDW estimates, with the local smoothing of the grade values from the composite input data. In the extreme east of the domain the IDW estimate begins to diverge from the NN estimate and the composite data, demonstrating that the estimate extrapolation is surpassing its range and reducing confidence in these blocks.

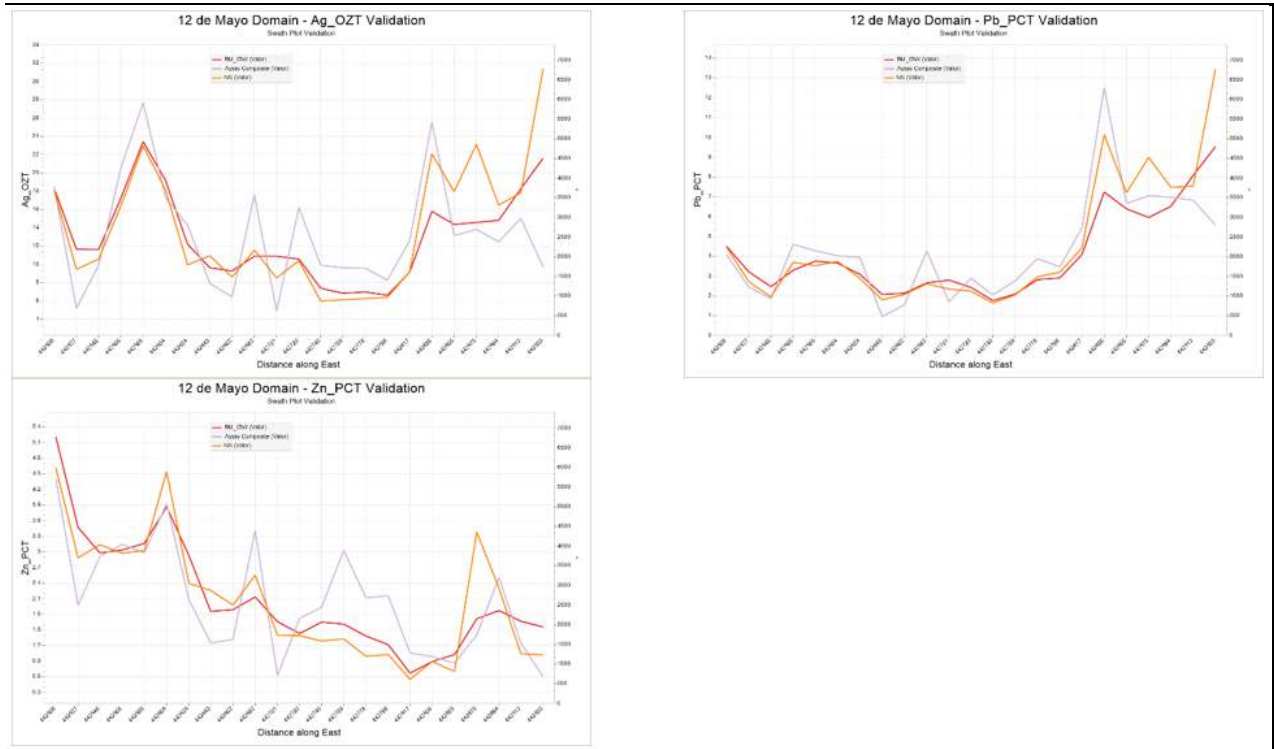

Figure 14-14: Swath Plot validations for the 12 de Mayo Domain showing Ag oz/t, Pb% and Zn% grades

### 14.11 Mineral Resource Classification

The classification of the resource is based upon the ranges observed in the variogram models and the number of the drill hole composites that went into estimating the blocks. The following table explains the definition used to define the different resource classifications.

Table 14-10: Resource classification parameters applied to the mineral resource estimation

	Distance		MnN <sup>o</sup>	MinN <sup>o</sup>
	X (along)	Z (down dip)		
Indicated	50	30	3	3
Inferred	90	70	2	2

After assigning of the classification of the blocks empirically using the parameters mentioned shown in Table 14-10, the model was reviewed and of the resulting classification adjusted based on the understanding of the geological interpretation, data density and production figures.



There mineral resource classification does not contain any blocks in the measured category as the exact location of the majority of the channel samples were not measured but were approximated, captured from maps, and translated to their final three-dimensional location.

Figure 14-15, Figure 14-16 and Figure 14-17 show the final classifications for the Española, Victoria and 12 de Mayo domains, respectively.

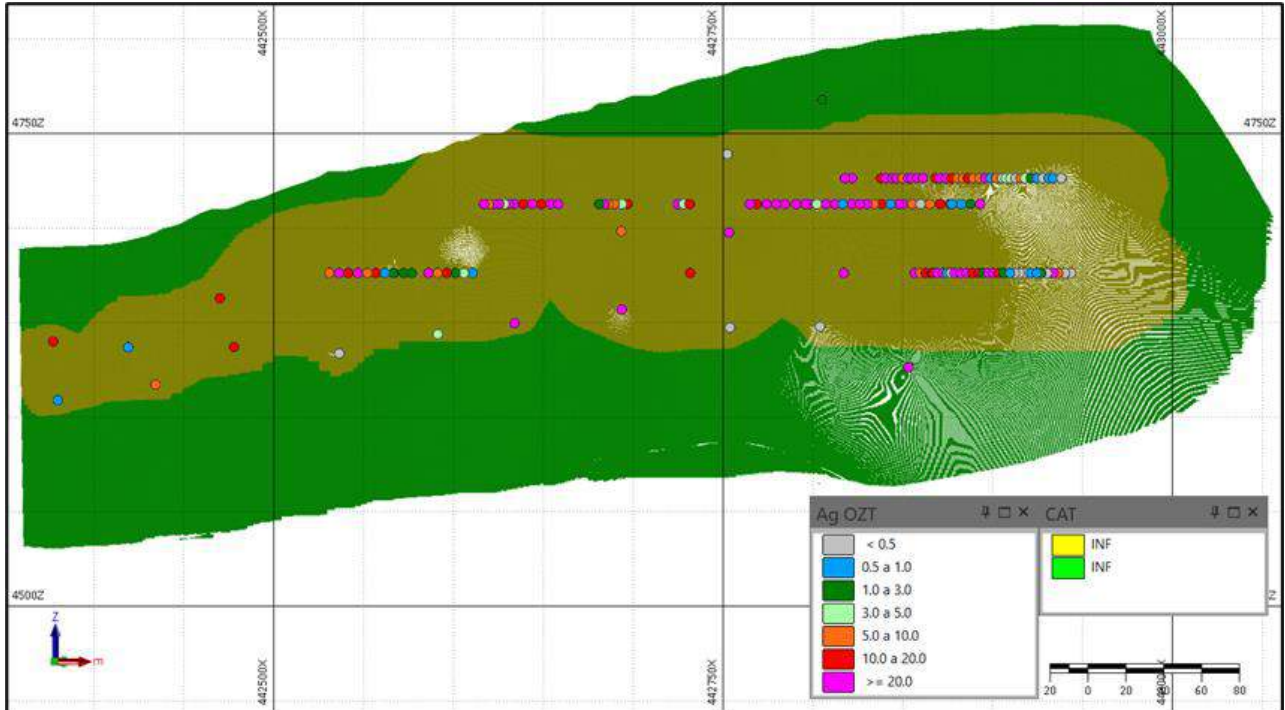

Figure 14-15: Final classification of the Española Domain

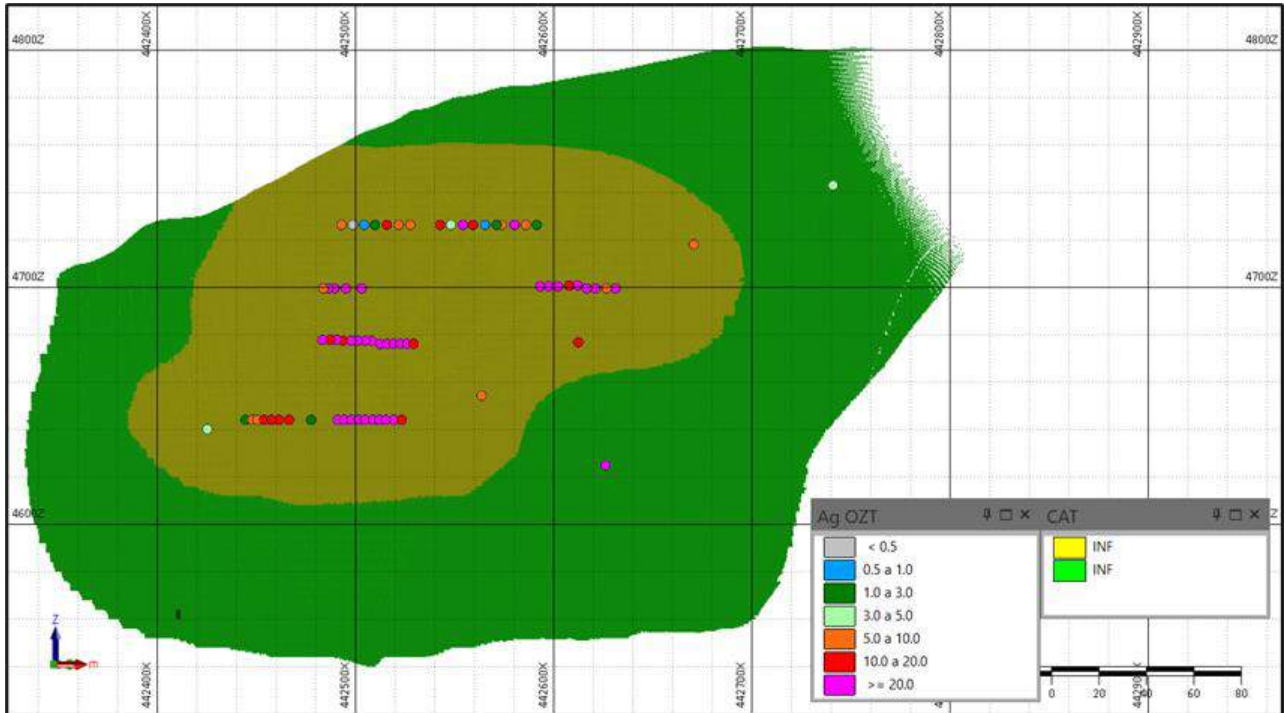

Figure 14-16: Final classification of the Victoria Domain

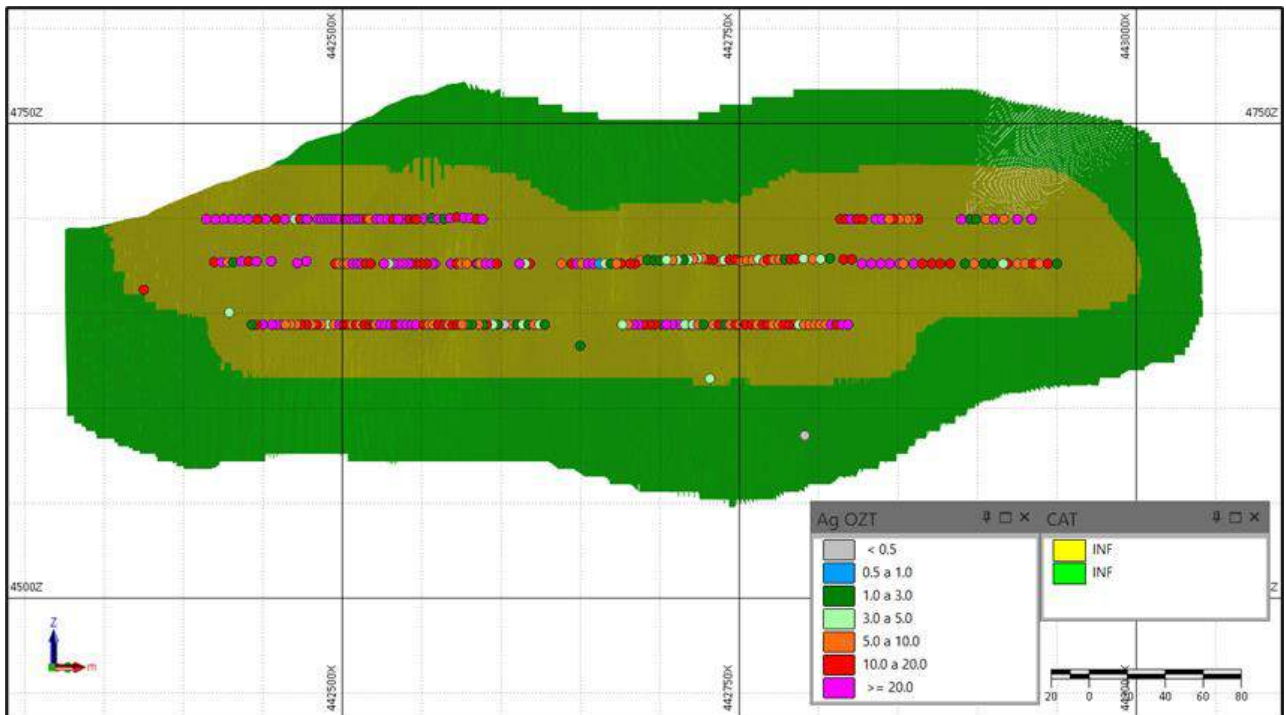

Figure 14-17: Final classification of the 12 de Mayo Domain

**14.12 Cut-off Grade**

In order to apply a cut-off to the resource estimation and to determine the amount of material that could be reasonably and economically extracted the sub-blocked model was regularised considering a minimum mining width of 0.6 m, the stope width of the historic mining operations. Table 14-11 shows how the variation in a change in cut-off grade effects the overall metal content, there a is slight and steady decrease in contained metal with an increase in cut-off grade, therefore the deposit is not sensitive to changes in variations in cut-off and hence metal prices. Figure 14-18 shows how the resource is sensitive to changes in cut-off; as the cut-off grade is increased the tonnes of the extractable material decreases but does not show any rapid decrease in contained metal value with respect to increasing in cut-off value.

*Table 14-11: Grade sensitivity analysis - tonnes and grade and contained metal for a range of AgEq cut-off values*

Cutoff Ag Eq (g/t)	Tonnage (t)	Average GradeAg Eq (g/t)	Ag Eq (oz)	% por metal Au	Metal Au (oz)	% por metal Ag	Metal Ag (oz)	% por metal Pb	Metal Pb (t)	% por metal Zn	Metal Zn(t)	% por metal Cu	Metal Cu (t)
90	1,162,159	375.8	14,040,673	5.3	10,315	65.1	9,142,109	14.4	26,005	12.0	16,173	3.1	1,381
100	1,104,443	390.5	13,864,734	5.2	9,954	65.3	9,050,635	14.4	25,705	12.0	15,906	3.1	1,358
110	1,058,191	402.9	13,708,686	5.1	9,665	65.4	8,967,740	14.4	25,426	12.0	15,677	3.1	1,338
120	1,012,933	415.8	13,541,457	5.0	9,279	65.6	8,882,327	14.5	25,150	11.9	15,422	3.1	1,320
130	970,671	428.5	13,371,499	4.9	9,008	65.7	8,787,472	14.5	24,839	11.9	15,177	3.1	1,302
140	931,955	440.7	13,203,467	4.8	8,753	65.9	8,695,055	14.5	24,523	11.8	14,918	3.0	1,285
150	891,336	454.1	13,014,482	4.7	8,404	66.0	8,591,084	14.5	24,150	11.8	14,682	3.0	1,266

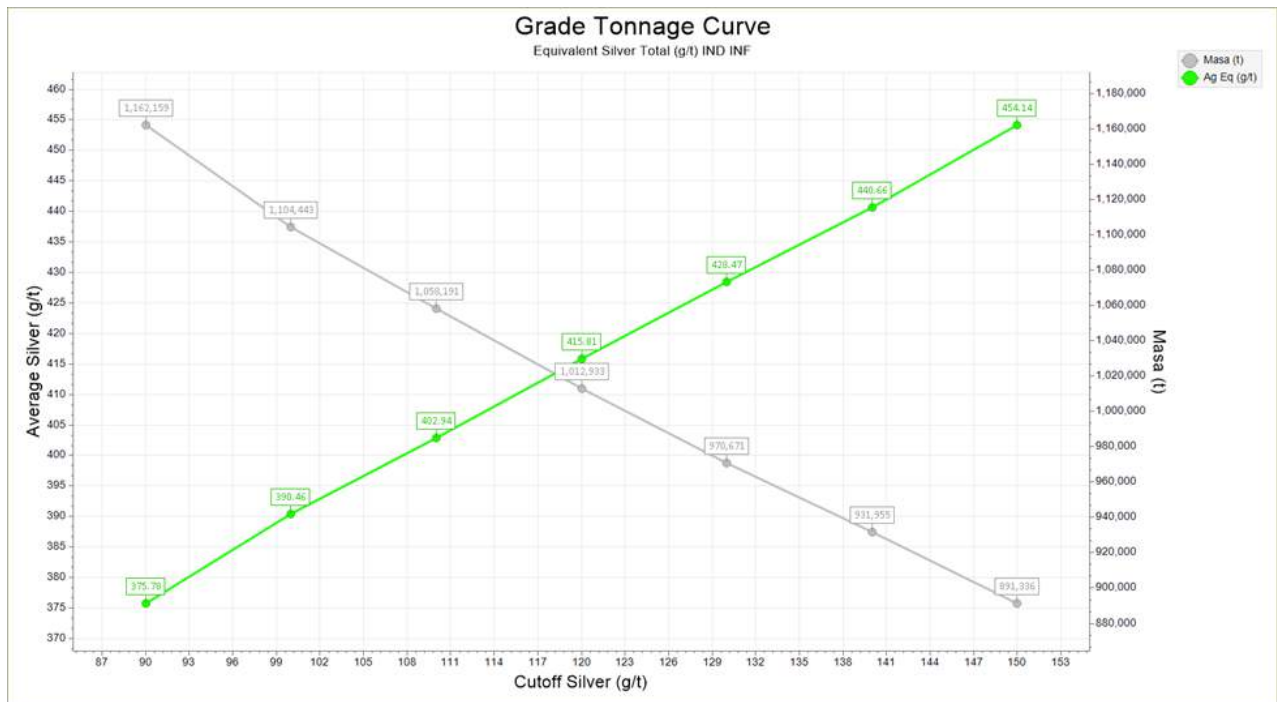

*Figure 14-18: Grade-Tonnage Curve for AgEq for the Bethania maiden Mineral Resource Estimate*

The regularised block was used in the final resource calculation and the resource statement, applying a cut-off value of 100 ppm silver equivalent (AgEq). The value of the 100 ppm AgEq was used as it approximates the break-even cut-off value calculated using the parameters in Table 14-18. Silver equivalent was used in preference to US Dollar value as the principal metal of value in the deposit is silver, representing between 70 and 74% of the total value.

### 14.13 Mineral Resource Statement

The maiden Mineral Resource Estimate consists of 18 different veins all located within the original mine area and includes data collected from the 2021 diamond drilling program as well as previously collected underground Channel samples. The resource estimate is solely focused on the main Bethania Mine area, with no mineral estimations from the newly identified and proximal Hilltop Zone. The maiden MRE Statement for the Bethania Silver Project is provided in Table 14-12.

Highlights of the maiden MRE include:

- Indicated resources of 5,858,521 oz silver equivalent\* at an average grade of 451 g/t Ag Eq contained in 404,000 tonnes.
- Inferred resources of 8,006,431 oz silver equivalent\* at an average grade of 356 g/t AgEq contained in 700,000 tonnes.
- Silver represents 74% of the gross metal value\* in the Indicated Resource and 70% of the gross metal value in the Inferred Resource.
- Approximately 63% of the Indicated silver equivalent ounces are located above the main historical production adit level (4670 Level).
- Identified three main mineralized structures that control the 18 veins included in the maiden MRE.
- Significant resources contained above the 4670 Level, including approximately 56% of the Indicated tonnes and 34% of the Inferred tonnes.
- Resource model extends to a maximum depth from surface of 230 m in the 12 de Mayo vein, 200 m in the Española vein and 180 m in the Victoria vein. All three vein systems appear to be similarly important in controlling silver mineralization and remain open along strike and at depth.

\*Silver equivalent (AgEq) is calculated using metal values for gold, silver, lead, and zinc and applying recovery factors. The calculation can be expressed with the following formula (F1):

$$\frac{(Au \text{ g/t})(Price \text{ Au } \$/oz)}{31.1} + (Ag \text{ oz/t})(Price \text{ Ag } \$/oz) + \frac{(Pb \%)(Price \text{ Pb } \$/t)}{100} + \frac{(Zn \%)(Price \text{ Zn } \$/t)}{100} + \frac{(Cu \%)(Price \text{ Cu } \$/t)}{100} \quad (31.1) = Ag \text{ g/t Eq}$$

$$\frac{(Au \text{ g/t})(1849.78 \$/oz)}{31.1} + (Ag \text{ oz/t})(25.44 \$/oz) + \frac{(Pb \%)(1981.79 \$/t)}{100} + \frac{(Zn \%)(2658.62 \$/t)}{100} + \frac{(Cu \%)(7971 \$/t)}{100} \quad (31.1) = Ag \text{ g/t Eq}$$

Table 14-12: Maiden Mineral Resource Estimate Statement, Bethania Silver Project, Peru

Category	Tonnage	GRADE						CONTAINED METAL	
		Ag	Pb	Zn	Au	Cu	AgEq	Ag	AgEq
		(g/t)	(%)	(%)	(g/t)	(%)	(g/t)	(oz)	(oz)
Indicated	404,000	332	2.63	1.95	0.26	0.16	451	4,317,540	5,858,521
Inferred	700,000	249	2.51	1.58	0.24	0.12	356	5,600,256	8,006,431

Eighteen veins were modelled in the MRE, which have been grouped into three vein systems based on the current understanding of the major structures controlling mineralization (Table 14-13). The vein systems appear to have strong structural controls along the broadly northeast-southwest trend of the Santa Elena concession, with various veins locally branching off the main structures. The vein groupings are as follows:

- Española Vein system includes Española, Española Footwall Branch (RFW), Carolina, Carolina II, Betsaida, Maria, Maria Footwall Branch (RFW), and Maria Footwall Branch 1 (RFW1), as well as Carolina Footwall Branch (RFW), which is identified as a structure but contains no resources.
- 12 de Mayo Vein system includes: 12 de Mayo, 12 de Mayo South, 12 de Mayo Footwall Branch (RFW), 12 de Mayo Footwall Branch 1 (RFW1), 12 de Mayo Hanging wall Branch (RHW), 12 de Mayo South Footwall Branch (RFW), 12 de Mayo South Hanging wall Branch (RHW), and New Vein, as well as New Vein Footwall Branch (RFW) which is identified as a structure but contains no resources.
- Victoria Vein system includes Victoria and Yolanda veins.

Table 14-13: Mineral Resources by interpreted vein system

Española Vein System			
Category	Tonnage	GRADE	CONTAINED METAL
		AgEq (g/t)	AgEq (oz)
Indicated	202,000	483	3,138,264
Inferred	273,000	369	3,237,942
12 de Mayo Vein System			
Category	Tonnage	GRADE	CONTAINED METAL
		AgEq (g/t)	AgEq (oz)
Indicated	107,000	366	1,254,019
Inferred	216,000	344	2,392,283
Victoria Vein System			
Category	Tonnage	GRADE	CONTAINED METAL
		AgEq (g/t)	AgEq (oz)
Indicated	96,000	477	1,466,238
Inferred	211,000	350	2,376,206

By analyzing the maiden MRE by elevation (Table 14-14 ; Figure 14-19, Figure 14-20 and Figure 14-21), approximately 56% of the Indicated tonnes and approximately 63% of the Indicated



AgEq ounces are located above the 4670 Level. Approximately 66% of the Inferred tonnes and 65% of the Inferred AgEq ounces are located below the 4670 Level. The 4670 Level was the main production adit level prior to the mine suspending operations in 2016, with minimal development and production occurring below that level. A significant portion of the maiden MRE is in the upper levels of the mine (above 4670 Level) while the mineral resources remain open at depth.

The maiden MRE figures consider material that has been extracted during production and material in the upper levels that cannot be extracted due to safety reasons.

Table 14-14: Mineral Resources above/below the 4670 Level

Resources Above 4670 Mine Level			
Category	Tonnage	GRADE	CONTAINED METAL
		AgEq (g/t)	AgEq (oz)
Indicated	227,000	503	3,678,457
Inferred	240,000	366	2,826,367
Resources Below 4670 Mine Level			
Category	Tonnage	GRADE	CONTAINED METAL
		AgEq (g/t)	AgEq (oz)
Indicated	177,000	384	2,180,064
Inferred	460,000	350	5,180,064

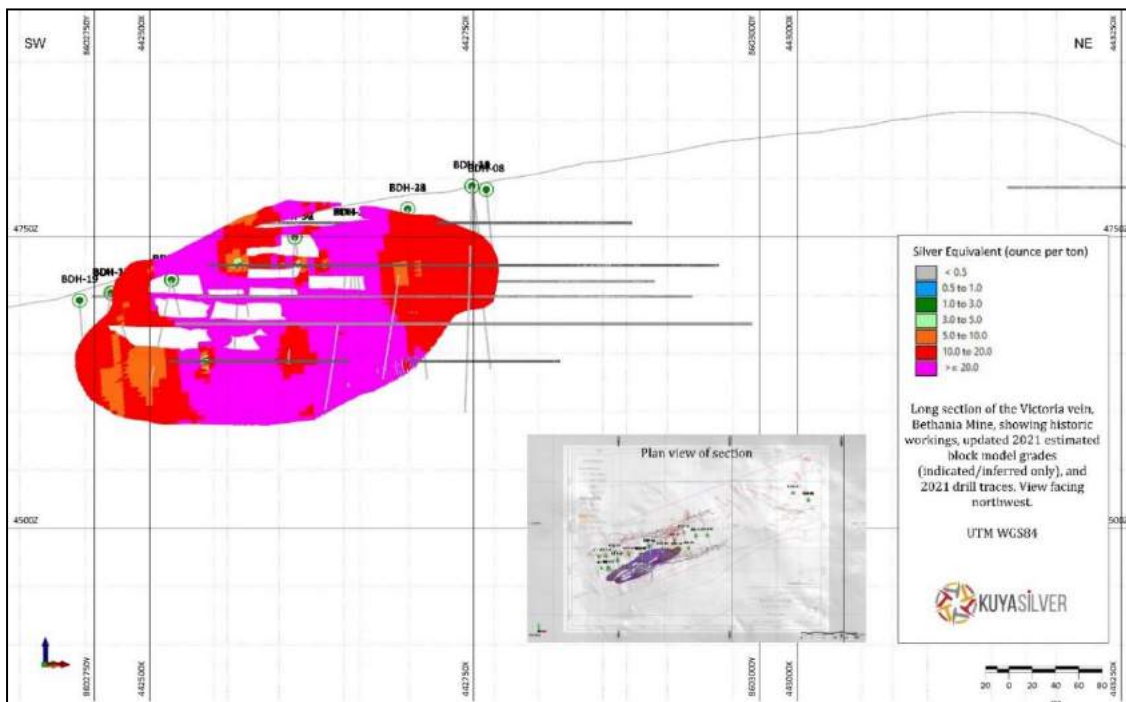

Figure 14-19: Victoria Vein long-section showing historical workings, updated 2021 estimated block model grades (Indicated/Inferred only), and 2021 drill hole traces



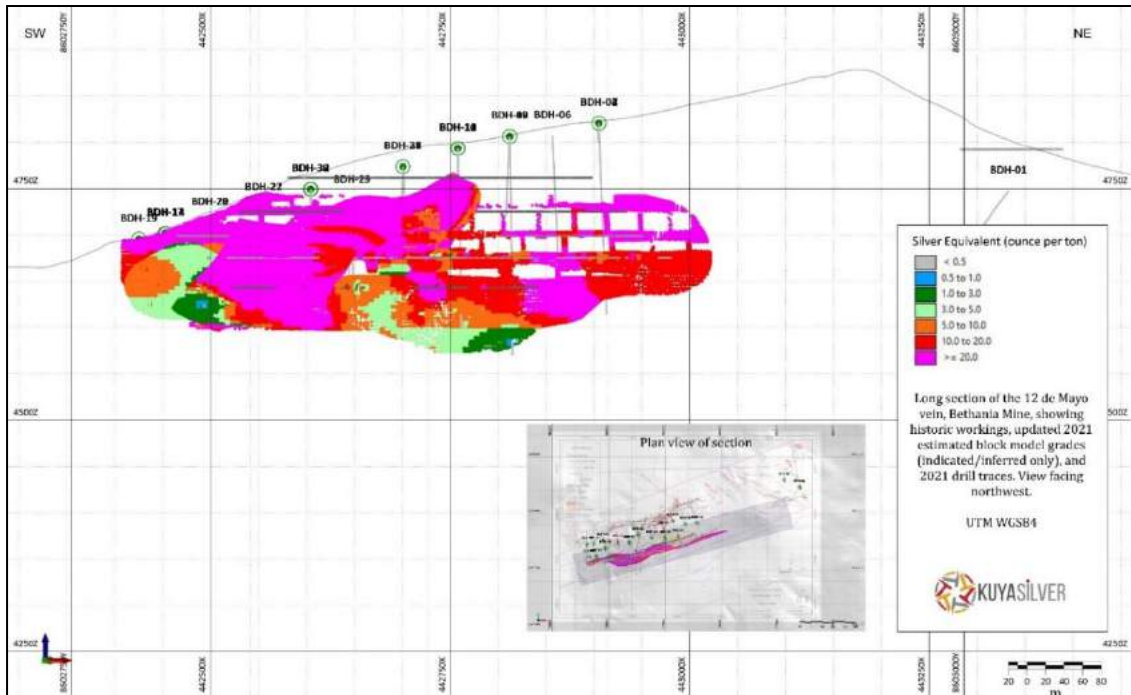

Figure 14-20: 12 de Mayo Vein long-section showing historical workings, updated 2021 estimated block model grades (Indicated/Inferred only), and 2021 drill hole traces

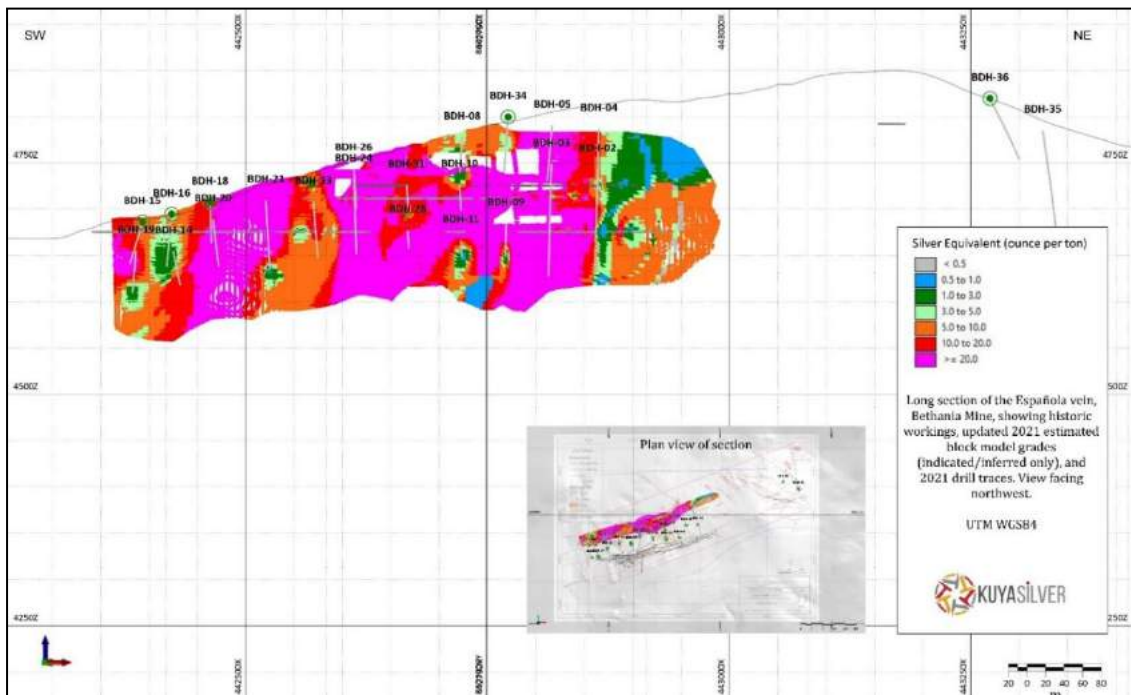

Figure 14-21: Española Vein long-section showing historical workings, updated 2021 estimated block model grades (Indicated/Inferred only), and 2021 drill hole traces

## 15 MINERAL RESERVE ESTIMATES

---

There are no Mineral Reserves declared in this Technical Report.

## 16 MINING METHODS

---

### 16.1 Summary

For the definition of the mining method with which the exploitation of the Santa Elena mine will be carried out, a qualitative and quantitative analysis (trade off) was developed between several mining methods that could be applied. To develop both analyses, a process map was generated consisting of:

- Qualitative analysis.
  - Evaluation using the UBC methodology.
  - Geomechanical evaluation.
  - Operational Evaluation (operational criteria of the selected method).
- Quantitative analysis (Gross margin: Income - costs).

#### **Qualitative analysis:**

The qualitative analysis was developed with the available geological information analysed using the UBC methodology (University British Columbia analysis method), where geometric information, type of deposit, geotechnical conditions of the mineral and geotechnical conditions of the stopes are entered. The results of the applicable mining methods are referential to the base parameters analysed. The Conventional Cut and Fill, Square Set and Shrinkage Stopping mining methods resulted in the best valuation for the deposit. The importance of the application of the UBC methodology is the identification of the alternatives with the best value for application in the specific deposit.

As a second analysis process, the geomechanical evaluation was developed, for which the modified stope stability graphic method (Potvin, 1988) was used to analyse the maximum dimensions of the stopes. In the case of the Santa Elena mine, the stopes are in the range of thicknesses from 1 to 3m and heights in a range of 2.1 to 3m, the maximum attainable length would be limited by the operation of the excavations. The operational part considers 2 sides per mining block and each side a length of 25 meters. It is worth mentioning that the available information does not allow determining or ruling out the possible presence of faulting parallel to the mineralized structure. Therefore, the use of wooden props within the area of exploitation is recommended, in order to control possible unstable blocks, primarily on the walls.

Under these considerations, the recommended exploitation methods for the rock mass conditions are Conventional Cut and Fill and Shrinkage Stopping.

From the qualitative analyses developed, it is concluded that the Conventional Cut and Fill and Shrinkage Stoping mining methods are the most suitable technical and operational alternatives for the exploitation of the Santa Elena mine.

**Quantitative analysis:**

In the qualitative analysis stage, Conventional Cut and Fill (OCF) and Shrinkage Stoping were identified as the best alternative mining methods for the exploitation of the deposit, with this input economic stopes were generated for both mining methods. The purpose of this process was to identify the option that presents the highest gross margin (Revenue - operating cost) for the project.

From the analyses carried out, it is concluded that the mining method suitable for the characteristics of the Santa Elena mine, both for the qualitative and quantitative analysis, is the Conventional Cut and Fill.

The project will develop the *circado* variant. This method comprises selective drilling, blasting and mucking of narrow veins as stage one in a two-part advance cycle, followed by drilling and blasting of the wall rock to the mining width (usually not less than 1 m) required for the next advance along the vein, which in the historical Mina Santa Elena “flat-back” stopes provided the stope fill and the platform required for repeat of the mining cycle.

**16.2 Geotechnical Considerations**

Mining Plus (MP) considers that the geotechnical parameters applied in this stage of the study are representative for the average conditions of the rock mass and appropriate for the level of study. They are obtained from the geotechnical domains and rock mass classification values prepared by Atticus Geoscience and presented in the report of 10/28/2021 - "Definition of Geomechanical Domains of Santa Elena Mine".

**16.2.1 Rock Mass Characterization – Q System**

The Q (rock mass quality index) system according to Barton and Grimstad (1993) was used to assess the rock mass quality of the mineralization and host rock and to give an estimate of development/stope stability and support requirements. The Q system quantitatively describes three aspects of the rock mass based on six geotechnical parameters, to arrive at a Q value (Table 16-1).

According to Barton et al., (1974) the values of Q can vary from 0.001 (very poor rock conditions) to 1000 (excellent rock conditions). The Atticus Geoscience Report, October 2021 provided a detailed evaluation of Q values based on available records.

$$Q = \left(\frac{RQD}{J_n}\right) * \left(\frac{J_r}{J_a}\right) * \left(\frac{J_w}{SRF}\right)$$

Table 16-1: Selective Mining Unit Dimensions by Zone and Mining Method

Area/Zone	Method	Length (m)	Height (m)	Width (m)
12 Mayo	OCF	5	2.1	0.6
Española	OCF	5	2.1	0.6
Victoria	OCF	5	2.1	0.6

Table 16-2: Rock Mass Rating Parameters

Main Geotechnical Parameter	Measured Parameter	Note
Rock block size	RQD	RQD as described by Deere (1967)
	Jn	Joint set number count
Joint shear strength	Jr	Joint roughness factor
	Ja	Joint alteration factor
Confining stress	JwS	Joint water reduction factor
	RF	Stress reduction factor

### 16.2.2 Rock Mass Characterization Using Rock Mass Rating

The following six parameters are used to classify the rock mass using the (RMR) classification system:

- Uniaxial compressive strength of rock material.
- RQD.
- Discontinuity spacing.
- Condition of discontinuities.
- Groundwater conditions.
- Orientation of discontinuities.

Each of the six parameters was assigned a value corresponding to rock characteristics, which were derived from field studies and laboratory tests. The sum of the six parameters is the "RMR value", which is between 0 and 100.

#### 16.2.2.1 Stope Sizing

Based on a review of available geotechnical information, rock mass conditions appear to be generally favorable. An evaluation of the stopes was carried out using the modified stability number ( $N'$ ) proposed by Potvin (1988) and initially based on  $Q'$ , where:

$$N' = Q' \times A \times B \times C$$

Where:

- Q' is the modified Q of the tunnelling quality index (previously Barton et al., 1974).
- A is the rock stress factor.
- B is the joint orientation factor.
- C is the gravity adjustment factor.

The value of N' can be used to calculate the maximum stable surface area of the walls and roof of the stopes, also known as the hydraulic radius.

### 16.2.2.2 Defined Geotechnical Parameters

A high-level review of the Santa Elena mine geotechnical information was carried out for the purposes of the PEA 2022, the results of which are provided in Table 16-2.

Table 16-3: Geomechanical Parameters for the UBC Methodology

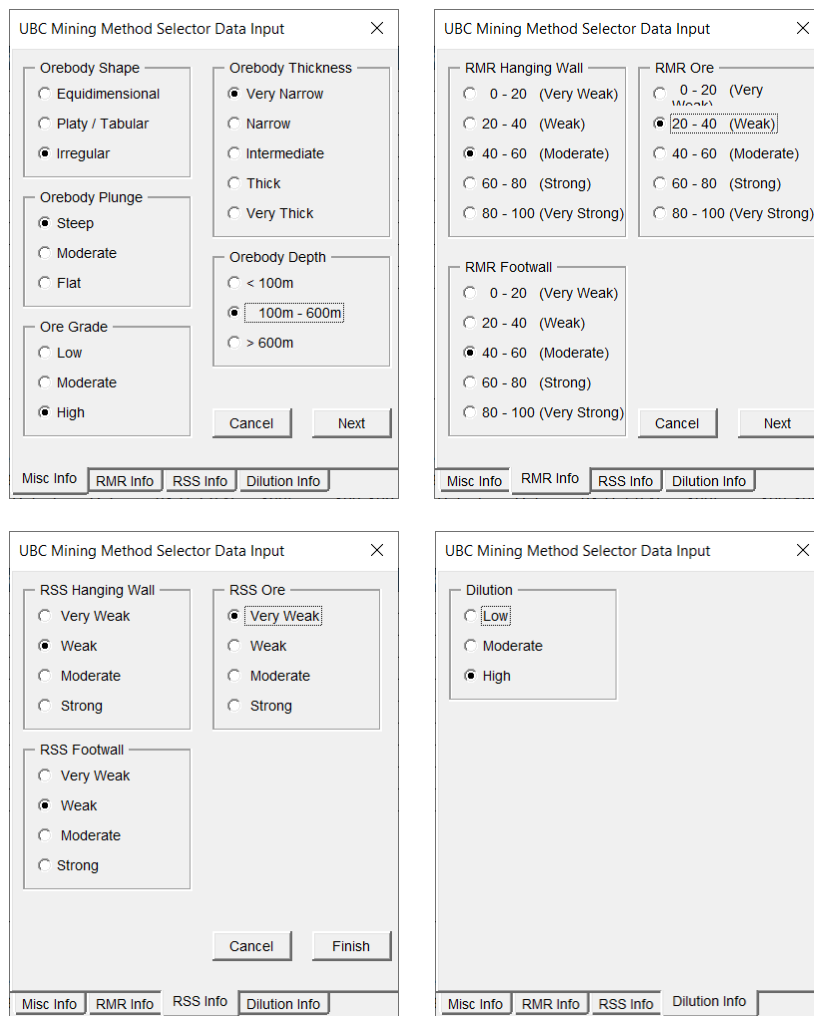

The figure displays four sequential screenshots of the 'UBC Mining Method Selector Data Input' dialog box, showing the selection of geomechanical parameters:

- Screenshot 1:** Orebody Shape (Irregular), Orebody Thickness (Very Narrow), Orebody Plunge (Steep), Orebody Depth (100m - 600m), Ore Grade (High).
- Screenshot 2:** RMR Hanging Wall (40 - 60 (Moderate)), RMR Ore (20 - 40 (Weak)), RMR Footwall (40 - 60 (Moderate)).
- Screenshot 3:** RSS Hanging Wall (Weak), RSS Ore (Very Weak), RSS Footwall (Weak).
- Screenshot 4:** Dilution (High).

These parameters were defined based on a geotechnical study conducted by Atticus Geoscience, which established rock mass characteristics to support the definition of preferred mining methods and design parameters (Atticus Geoscience, 2021).



Localized fault zone impacts could lead to lower RMR values in certain areas, which would need to be managed on a case-by-case basis and should be investigated and detailed in future studies.

Waste rock with a density of 2.7 g/m<sup>3</sup> was considered.

The proposed minimum and maximum stable length along strike for the walls are summarized in Table 16-4.

*Table 16-4: Maximum stable length along strike distance (Walls)*

Structure	Domain	HR	Height (m)	Length (m)
12 de Mayo	Mineral	1.75	2.1	25
Española		1.75	2.1	25
Victoria		1.75	2.1	25

### 16.3 Mining Method Selection

The UBC methodology was used to select the most suitable mining method for the Santa Elena mine, considering the shape of mineralization, review of geotechnical information (RMR and characteristics of the footwall and hanging wall), distribution of grades and the general characteristics of the mine (for example, width, dip and depth).

#### 16.3.1 UBC Mining Method Selection System – Qualitative Analysis

The UBC Method is a modification of Nicholas's (1981) approach. According to Nicholas, each extraction method is classified according to the parameters of geometric distribution, grade of mineralization, location (distance to surface) and the geomechanical characteristics of the hanging wall and footwall.

*Table 16-5: Geomechanical Parameters for the UBC Methodology*

ITEM	Parameters for Kuya Silver
Shape	Irregular
Plunge	Steep
Depth	10 – 600 m.
Thickness	Very Narrow
Grade	High
RMR HW	Moderate / Weak
RMR MM	Weak
RMR FW	Moderate / Weak
RSS HW	Very Weak / Weak
RSS MM	Very Weak

ITEM	Parameters for Kuya Silver
RSS FW	Very Weak / Weak

The steps in the selection process considered the following:

- Description of the geometry of the mineralized material.
- Geomechanical characteristics of the mineralization, hanging wall and foot wall.

The mining methods likely to be applicable at Santa Elena through the UBC assessment were:

- Sublevel stopping
- Cut-and-fill
- SquareSet
- Open Pit
- Top Slicing
- Sublevel Caving
- Shrinkage stopping
- Block Caving
- Room and Pillar
- Longwall.

A classification of the UBC methodology is established for possible methods of underground mining. In Table 16-6 shows the mining methods with a probability of being applied and the methods that are discarded.

Table 16-6: UBC Comparative Table by Underground Mining Method

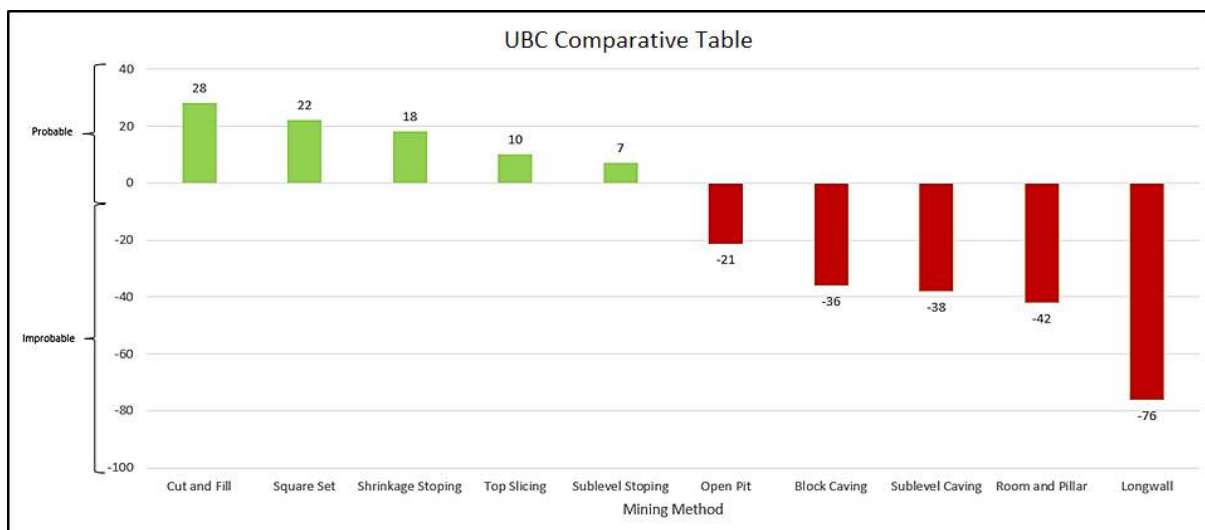

From the analysis developed by the UBC methodology, the results of the applicable mining methods are referential to the base parameters analysed. The Conventional Cut and Fill, Square Set and Shrinkage mining methods offer the best value for the deposit. The

importance of the application of the UBC methodology is the identification of the alternatives with the best value for the application in the specific deposit.

As a result, Mining Plus selected the Cut and Fill and Shrinkage methods for the PEA 2022. Schematics of the mining methods are shown in Figure 16-1 and Figure 16-2.

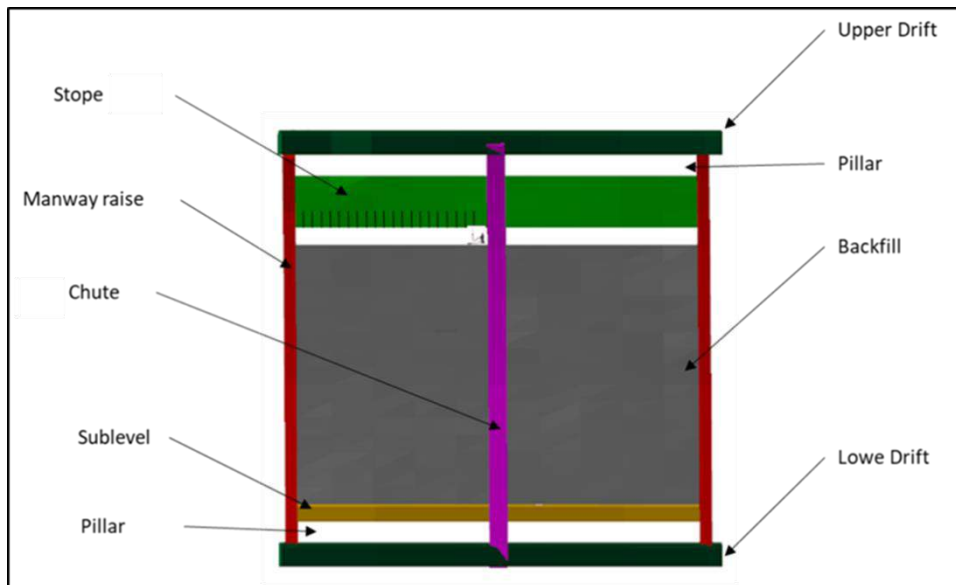

Figure 16-1: Cut and Fill Conventional – Schematic. Own elaboration.

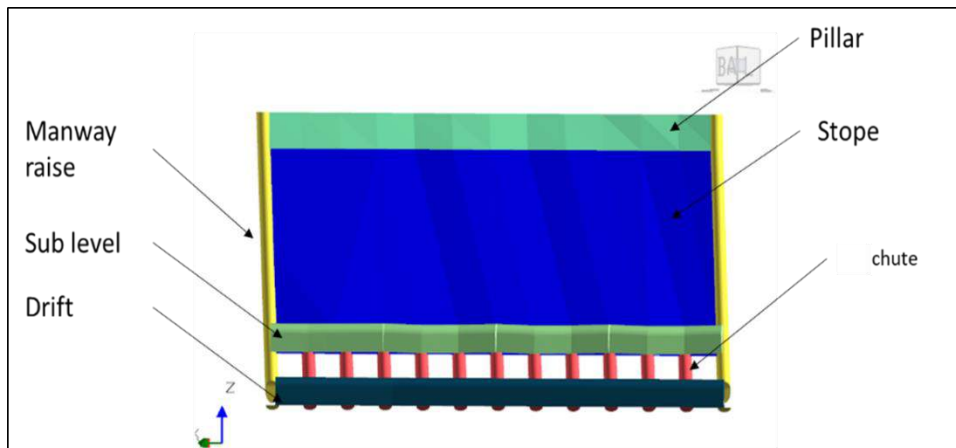

Figure 16-2: Shrinkage – Schematic. Own elaboration.

### 16.3.2 Trade Off Mining Method – Quantitative Analysis

According to the results obtained in qualitative analysis, the applicable methods for the deposit are Conventional Cut and Fill (OCF) and Shrinkage Stopping. In this study, a quantitative analysis was carried out for the selection of the preferred mining method for the mineral deposit, for which an economic comparison (gross margin) was carried out for each mining method. This analysis was carried out by area (12 mayo, Española y Victoria) and veins. The method with better margins defined the preferred mining method for the Santa Elena mine.

The Conventional Cut and Fill method is the one that obtains the best economic results compared to Shrinkage stopping, achieving a 54% higher economic margin.

Mining Plus determined based on the qualitative and quantitative evaluation that the mining method applicable to the Santa Elena mine is the conventional Cut and Fill method.

### 16.4 Mining Recovery and Dilution

A mining recovery of 95% was assumed for the Conventional Cut and Fill method and the operational dilution (% variable dilution) was applied, where a minimum width of 0.6 m is established, and the dilution value is variable depending on the width of the vein. The circado variant will allow the dilution to be controlled given its applicability in narrow veins and stability control in the stopes.

The total dilution is made up of internal dilution (dilution generated at the design width of the stopes) and operational dilution that is generated by the effects of the mining process. Table 16-7 and Table 16-8 show the mining recovery for the extraction method and the operational dilution parameters applied as a function of the design mining width.

*Table 16-7: Projected Zone Recovery by Mining Method*

Zone	Mining Method	Mining Recovery (%)
12 de Mayo	OCF	95
Española	OCF	
Victoria	OCF	

Table 16-8: Projected Dilution by Mining width

Layout Width			% Unplanned Dilution
0.60	to	1.00	16.4%
1.00	to	1.20	12.1%
1.20	to	1.50	10.1%
1.50	to	2.00	8.0%
2.00	to	3.00	5.9%
3.00	to	4.00	4.2%
4.00	to	5.00	3.3%
5.00	to	5.10	3.3%

## 16.5 Selection of Throughput Rate

A conceptual evaluation was developed to estimate the optimal production rate by applying the Taylor rule, for which the stopes generated above the cut off of 98.95 \$/t will be used, which are operationally viable for exploitation. Taylor's rule is based on the following equation:

- $\text{Tonnes}_{\text{day}} = 0.014 \times \text{re}_{\text{exp}}^{0.75}$

Where:

- $\text{Tonnes}_{\text{day}}$ : daily production capacity
- $\text{re}_{\text{exp}}$ : economic mineral

Based on Taylor's rule analysis, the 350 t/d rate was considered to be a sustainable and adequate production rate for the proposed operation.

This gave a variable extraction rate for the different zones of the Santa Elena mine, as presented in Table 16-9 for a production rate of 350 t/d.

Table 16-9: Conceptual Daily Production Scale Defined by Area/Zone

Zone	Method of	NSR Cutoff $\geq$ \$98.95	Production Scale Range			
	Mined		Tonnes	min	Max	Average
				(t/d)	(t/d)	(t/d)
12 de Mayo	OCF	253,102	126	190	158	
Española	OCF	368,169	167	251	209	
Victoria	OCF	235,807	120	180	150	
<b>Total</b>		<b>857,078</b>	<b>315</b>	<b>473</b>	<b>394</b>	

According to the Table 16-9, production rates were zone oriented which were then used in the consolidated mine plan as shown in Table 16-10.

*Table 16-10: Daily Production Scale defined by Zone*

Zone	Mining Method	Tonnes per Day (TPD)
12 de Mayo	OCF	100
Española	OCF	153
Victoria	OCF	97

The mineralized material will be obtained from the stopes and development, maintaining an average and continuous production rate of 350 t/d.

## 16.6 Cut-off

Considering the production rate of 350 t/d and mining by conventional Cut and Fill, the cut off is estimated, which considers the costs of mining, Mine G&A, preparation, sustaining CAPEX, plant OPEX and Total G&A. In Table 16-11 the estimated Break Even Cut Off is presented.

*Table 16-11: Cut Off by activity*

Item	Activity	\$/t
1	Drilling	9.38
2	Backfill	4.11
3	Blasting	6.08
4	Haulage	4.86
5	Ground Support	6.3
6	Chute Road	7.58
7	Auxiliary services	4.92
	Pumping	2.06
	Ventilation	2.86
8	Maintenance	1.16
9	Energy	1.8
<b>Exploitation Cost</b>		<b>46.19</b>
10	G&A Mine	2.41
11	Preparation	5.54
<b>Mine OPEX</b>		<b>54.14</b>
12	Sustaining Capex	3.06
<b>Plant OPEX</b>		<b>25.26</b>
<b>Total G&amp;A</b>		<b>16.49</b>
<b>BREAK EVENT Cut Off</b>		<b>98.95</b>

Mining Plus used information attained from similar projects in the region and from a benchmark database to support the cut off determination summarized in Table 16-12.

*Table 16-12: Projected Mining Cost by Activity*



Activity	\$/t
Exploitation Cost	46.19
G&A Mine	2.41
Preparation	5.54
<b>Mine OPEX</b>	<b>54.14</b>
Sustaining CAPEX	3.06
Plant OPEX	25.26
Total G&A	16.49
<b>Break Even Cut Off</b>	<b>98.95</b>

## 16.7 Subset of the Mineral Resource Estimate Within the 2022 PEA Mine Plan

In Table 16-13 the economically extractable Subset of the Mineral Resource Estimate is presented, which is above the cut off of 98.95 \$/t and considers recovery and dilution effects on stopes.

Table 16-13: Subset of the Mineral Resource Estimate Within the 2021 PEA Mine Plan – Cutoff > 98.95 USD/t

Category	Tonnes (t)	Ag (g/t)	Pb (%)	Zn(%)	Cu(%)	Au (g/t)	NSR (\$/t)
Indicated	310,710	9.34	2.24	1.70	0.14	0.23	243
Inferred	546,368	7.57	2.37	1.46	0.11	0.19	203
<b>Total</b>	<b>857,078</b>	<b>8.21</b>	<b>2.32</b>	<b>1.54</b>	<b>0.12</b>	<b>0.20</b>	<b>218</b>

## 16.8 Design Assumptions and Design Criteria

### 16.8.1 Selective Mining Unit

Table 16-20 shows the values of the minimum mining unit (SMU) defined for each area of the mine, the mining width is variable and is adapted to the width of the mineralized structure.

Table 16-14: SMU Dimensions by Proposed Mining Method

Zone	Length (m)	Height (m)	Mining Method
12 de Mayo	5	2.1	OCF
Española	5	2.1	OCF
Victoria	5	2.1	OCF

In Table 16-15 the sections for the development and other infrastructure to be carried out as part of the mine infrastructure are presented.

Table 16-15: Mining sections for preparation and development

Type	Section	
	Width (m)	Height (m)
Chute	2.2	2.4
Raise Room	2.1	2.1
Manway raise	1.2	1.2
Service raise	2.2	2.4
Crosscut to Drift	3.0	3.0
Crosscut to raise	2.1	2.1
Drift	3.0	3.0
Inclined Shaft	1.8	2.1
Sublevel	1.2	2.1

**16.8.2 Production Levels**

The NSR of US\$98.95/t was assumed for the optimization of the SMU. For the areas or zones to be mined by the conventional Cut and Fill mining method, 50m mining blocks are generated. for the stopes below Level 670. For the blocks generated above Level 670, 30m mining blocks have been generated. Each mining block is made up of chimneys at the ends, a pass/escape way in the central part, a sub-level in the first cut of the block and a base drive that runs along the mineralized structure. The mining is ascending, and the filling will be carried out by means of excavations (filling with waste from the hanging wall).

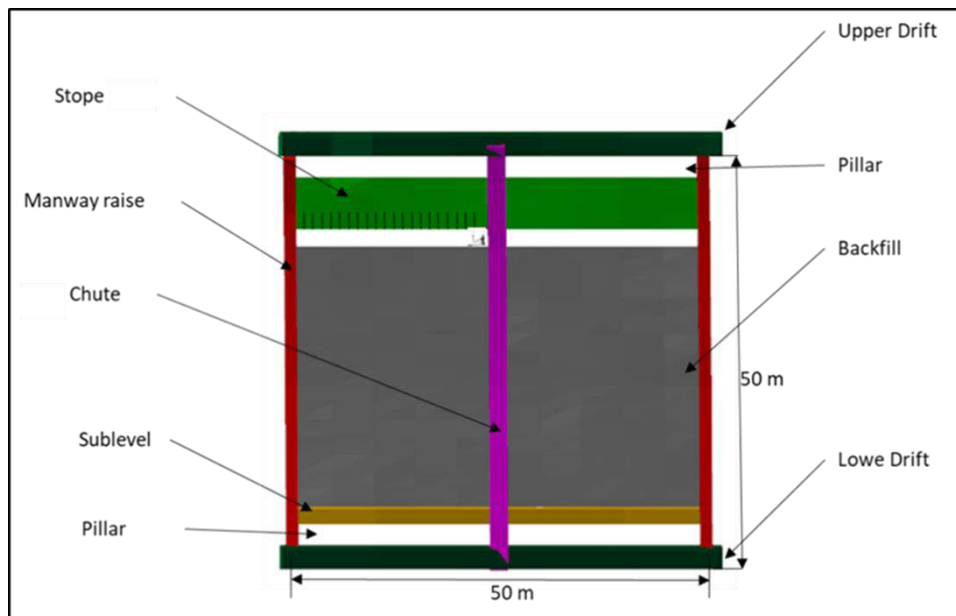

Figure 16-3: 50X50m OCF panel. Own elaboration.

**16.8.3 Access**

It is proposed to access the mine through the old infrastructure developed at levels 670, 690, 700 and 740 and the inclined shaft (level 630), which are in the process of being rehabilitated.

For the upper levels, personnel and equipment will enter through the rehabilitated mine entrances and for the area below level 670, a service chimney is projected, and the stope will be completed. The infrastructure will allow access for personnel, equipment, and services.

In Figure 16-4 the scheme of the proposed mine design is presented and in Figure 16-5 shows the access points of the mine, both for the upper and lower zone.

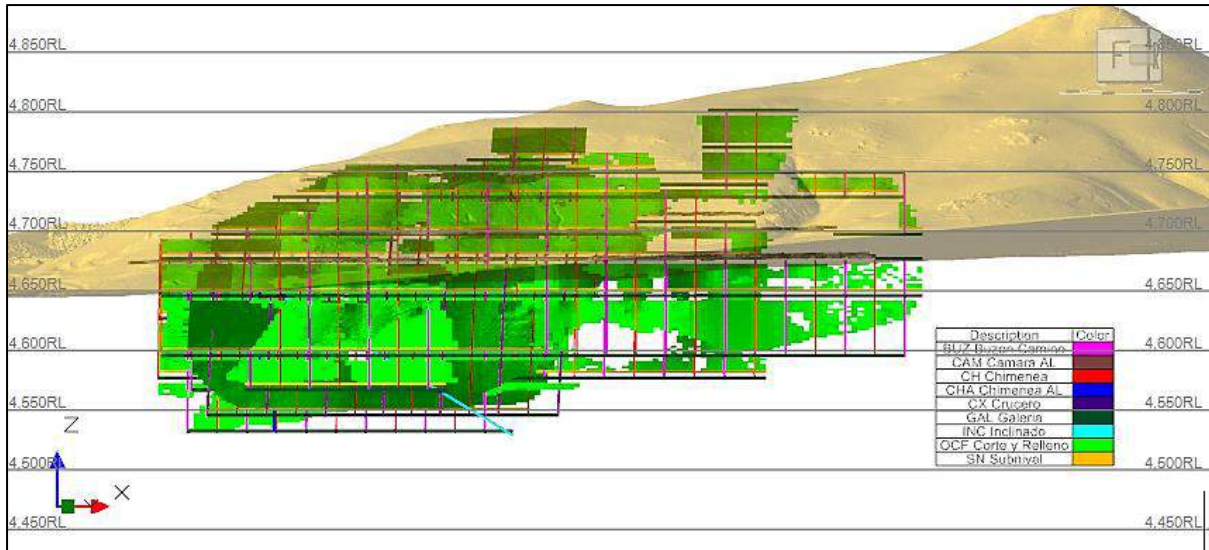

Figure 16-4: Mining Design – OCF, Isometric view. Own elaboration.

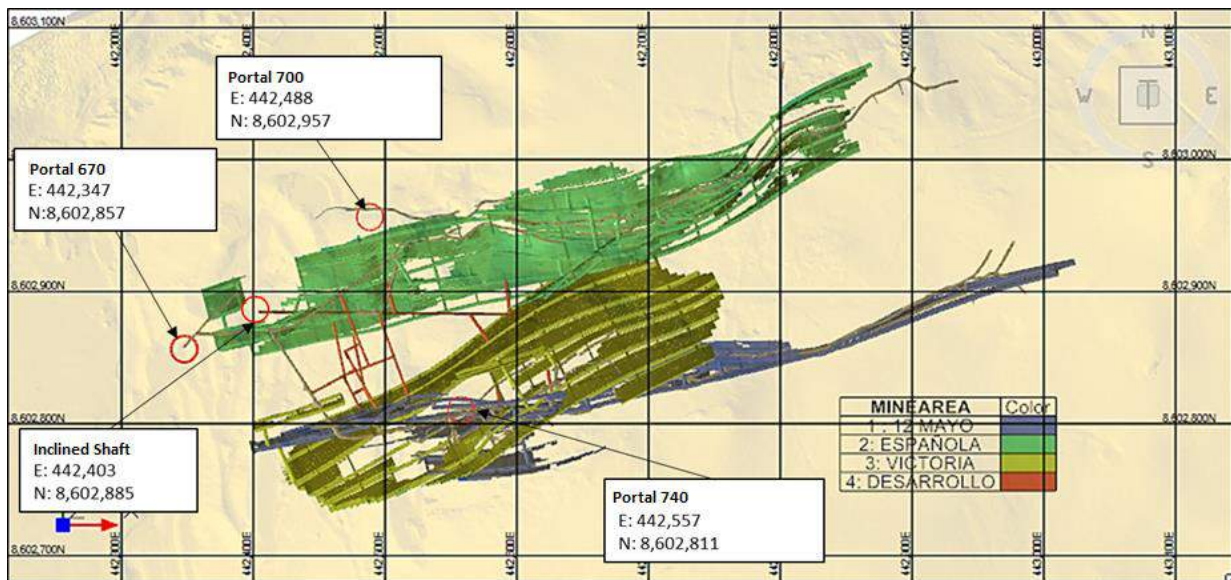

Figure 16-5: Mining Access – OCF, plan view. Own elaboration.

The mine plan assumes the following:

- At the beginning of month 7 during the pre-production stage, the level 670, 690 and the inclined shaft has been restored. In the following months before the end of year 0, the completion of 700 and 740 is projected.

- At the main levels of mineralized material extraction, there will be locomotive lines for mineralized material hauling.
- The construction of the service chimney will be carried out in year 1 and its deepening will be aligned with the execution of the infrastructure of the lower zone of level 670. It is considered that the deepening of the inclined shaft will be an activity in parallel to the deepening of the chimney of services.
- The mine plan was developed in specialized Deswik mining software. Deswik.CAD, Deswik.IS and Deswik.Sched mine planning packages were used. These packages allow the development of a mining plan following the design standards, and the logical sequencing for the selected mining method based on the constraints.

## 16.9 Backfill

The stopes will be backfilled in two ways:

- Waste fill from the development.
- Waste fill from the slashing of the footwall of the stopes.

*Table 16-16: Annual Fill Requirements*

Fill	unit	Preproduction	1	2	3	4	5	6	7	Total
Volume to fill (Stopes + Sublevels)	m <sup>3</sup>	5,267	21,627	29,282	27,952	28,615	28,738	33,428	21,615	196,524
Waste Volume	m <sup>3</sup>	3,666	20,375	26,209	27,173	19,642	26,026	31,226	21,615	175,932

As presented in Table 16-16, the volume to be filled (free volume due to the mining of stopes and sublevels) is greater than the waste generated from the year of pre-production until the end of the mine, this allows defining that no waste will be sent to the surface and the waste generated by the development work will be used to fill in the mined stopes.

## 16.10 Ventilation

### 16.10.1 Introduction

To estimate the required air capacity, simulations were developed in the Ventsim Design version 5.4 software for which mine infrastructure parameters were used, the dimensions and shapes of the cross sections of the internal ducts, their length, the roughness of the walls, the altitude (meters above sea level) of the mine location and the operating curves of the main fans.

### 16.10.2 Legislation

The requirements and estimates of the air flow required for the Santa Elena mine are based on Supreme Decree No. 024-2016-EM and its Amendment DS No. 023-2017-EM Occupational Health and Safety Regulations:

- Comprehensive evaluation of Ventilation, Subchapter VIII, Article 252.
- Ventilation, Subchapter VIII, Article 246.
- Personnel, Subchapter VIII, Article 247.
- Air speed in work, Subchapter VIII, Article 248.

### 16.10.3 Air Requirement Calculation

When equipment with a diesel engine is not used in the operation: The total flow rate for the operation must be calculated according to the formula detailed below and then compared with the flow rate due to the consumption of explosives. After obtaining each of the values, the one with the highest value is determined as the Total Air Requirement.

The air demand inside the mine must be calculated according to literal d) of article 252 of the regulation, considering the following formula:

$$Q_{To} = Q_{T1} + Q_{Fu}$$

Where:

$Q_{To}$  = Total flow for operation

$Q_{T1}$  = The sum of flow required by:

- a) Number of workers ( $Q_{Tr}$ )
- b) Wood consumption ( $Q_{Ma}$ )
- c) Temperature in wor tasks ( $Q_{Te}$ )

$Q_{Fu}$  = 15% de  $Q_{T1}$

### 16.10.4 Performed activities

For the elaboration of the ventilation system, the 3D survey of the existing works and the mine design that was developed for the LOM were considered. Mining plus, did not carry out field measurements of the connections from the mine to the surface, for later stages it will be necessary to confirm the location of these points so that the model of the ventilation system can represent the current situation of the mine and the future projections of the LOM plan.

In Figure 16-6 ,an isometric view of the mine in Ventsim is shown, where it is identified by type of work (drift, sublevel, inclined shaft, mineralized material chute, raise room, manway raise, service raise, crosscut, old topography).



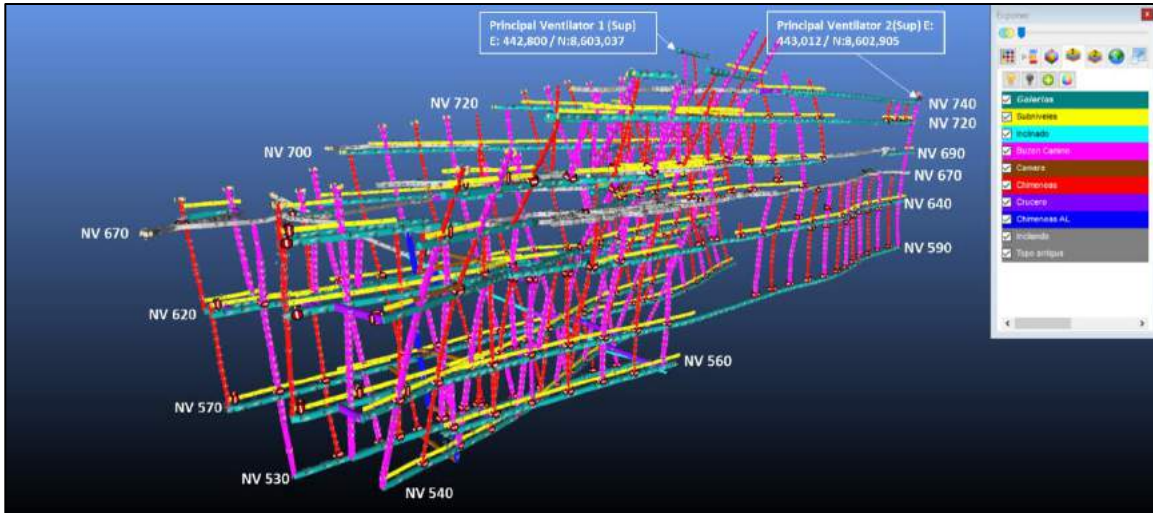

Figure 16-6: Isometric View of mine in Ventsim. Own elaboration.

**16.10.5 Air Requirement Calculation**

Kuya Silver is a conventional mine, in which only pneumatic equipment will be used, combustion equipment will not be used, the calculations made are detailed below:

**a) Flow required by the number of workers (QTr)**

The KS mine is located at more than 4,000 meters above sea level, in Table 16-17 the calculation of Qtr is detailed.

Table 16-17: Calculation of Qtr

Description	Value	Units
<b>F:</b>	<b>6</b>	<b>m<sup>3</sup>/min</b>
<b>N:</b>	<b>83</b>	<b>person / guard</b>
N Stopes:	44	
N Advances:	39	
<b>Q tr:</b>	<b>498</b>	<b>m<sup>3</sup>/min</b>

**b) Flow required for wood consumption (QMa)**

In the Table 16-23 the factors and the calculation to obtain the QMa are shown.

Table 16-18: Calculation of QMa

Description	Value	Units
<b>u:</b>	<b>1</b>	<b>m<sup>3</sup>/min</b>
<b>T:</b>	<b>175</b>	<b>ton</b>
<b>Q Ma:</b>	<b>175</b>	<b>m<sup>3</sup>/min</b>



**c) Flow required by temperature in work tasks (QTe)**

According to the statistical information of the mine, in the Kuya Silver mine there were no temperatures higher than 24° C, therefore, the QTe is zero.

**d) Flow rate required for leaks (QFu)**

Q Fu: 100.95 m<sup>3</sup>/min

**e) Required flow rate for explosive consumption (QEx)**

In Table 16-19 the detail of the calculation for the QEx is shown.

*Table 16-19: Calculation of QMa*

Description	Value	Units	Comments
<b>A:</b>	<b>4.7</b>	<b>m<sup>2</sup></b>	
<b>V:</b>	<b>25</b>	<b>m/min</b>	<b>Dynamite</b>
<b>N:</b>	<b>20</b>	<b>Fronts</b>	
N Stopes:	15		
N Advances:	15		
<b>Q Ex:</b>	<b>3528</b>	<b>m<sup>3</sup>/min</b>	

Finally, we have that the Qto from the flows previously calculated (Table 16-20).

*Table 16-20: Calculation of QTo*

Description	Value	Units
QT1:	673	m <sup>3</sup> /min
QFu:	101	m <sup>3</sup> /min
<b>Qto:</b>	<b>774</b>	<b>m<sup>3</sup>/min</b>

The QTo is lower compared to the 3,528 m<sup>3</sup>/min obtained by explosive consumption, in this sense this value would be the air requirement for the KS mine (Table 16-21).

*Table 16-21: Flow required by the KS mine*

Total Air Required		
Qto:	3,528	m <sup>3</sup> /min
Qto:	124,590	cfm
Qto:	59	m <sup>3</sup> /s

16.10.6 Proposed fans

To comply with the mine air requirement, two 60 k CFM fans were proposed. These fans will serve as extraction of stale air as they are located on the surface, and their operation will be independent for the zone of Española and Victoria & 12 de Mayo. In the Figure 16-7 the proposed fan curve is shown.

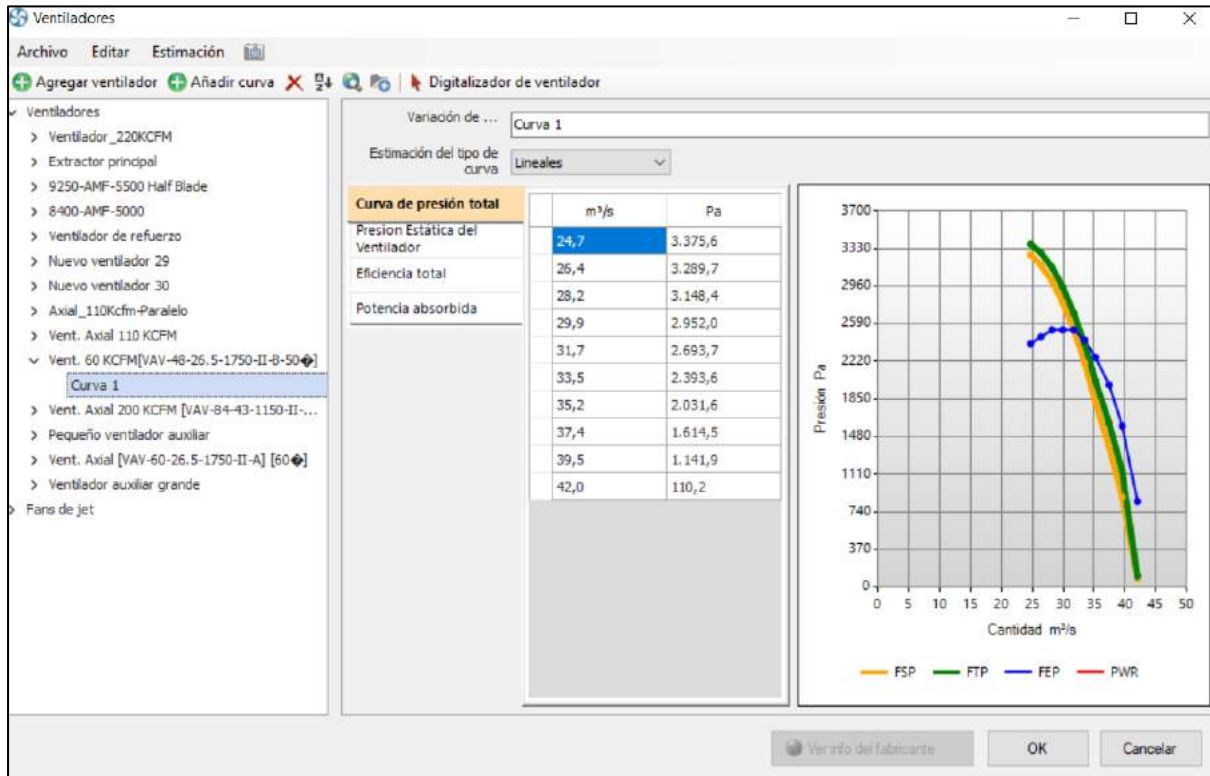

Figure 16-7: Main fan curve. Own elaboration.

16.10.7 Modeling results

In Table 16-22 the result of the Ventsim modeling of the main ventilation system is detailed.

Table 16-22. Main ventilation system

System Network Summary	
Compressible air flows	Yes
Natural ventilation pressure	No
Fan pressure simulation type	Total pressure method
Stage	0
Air ducts	6,089
Current stage segments	1,308
Total length	31,685 m.
Total intake aire flow	77.8 m <sup>3</sup> /s
Total exhaust aire flow	78.9 m <sup>3</sup> /s
Total mass flow	89.90 kg/s

System Network Summary	
Mine resistance (without tube)	0.12341 Ns <sup>2</sup> /m <sup>8</sup>
Mine resistance (includes conduit)	0.12341 Ns <sup>2</sup> /m <sup>8</sup>

In Table 16-23, the intake air coverage of the ventilation system modeled in Ventsim is shown.

*Table 16-23: Air coverage of the ventilation system in Ventsim*

Air coverage		
Air requirement	59	m <sup>3</sup> /s
Air intake	78	m <sup>3</sup> /s
<b>Coverage:</b>	<b>132%</b>	

The percentage of coverage is higher than the minimum requirement of the project (+32%), considering the provisions of Annex 38 of Supreme Decree No. 024-2016-EM and its Amendment DS No. 023-2017-EM Health and Safety Regulations Occupational.

In Figure 16-8 the isometric view of the ventilation flow for the Santa Elena mine infrastructure is presented.

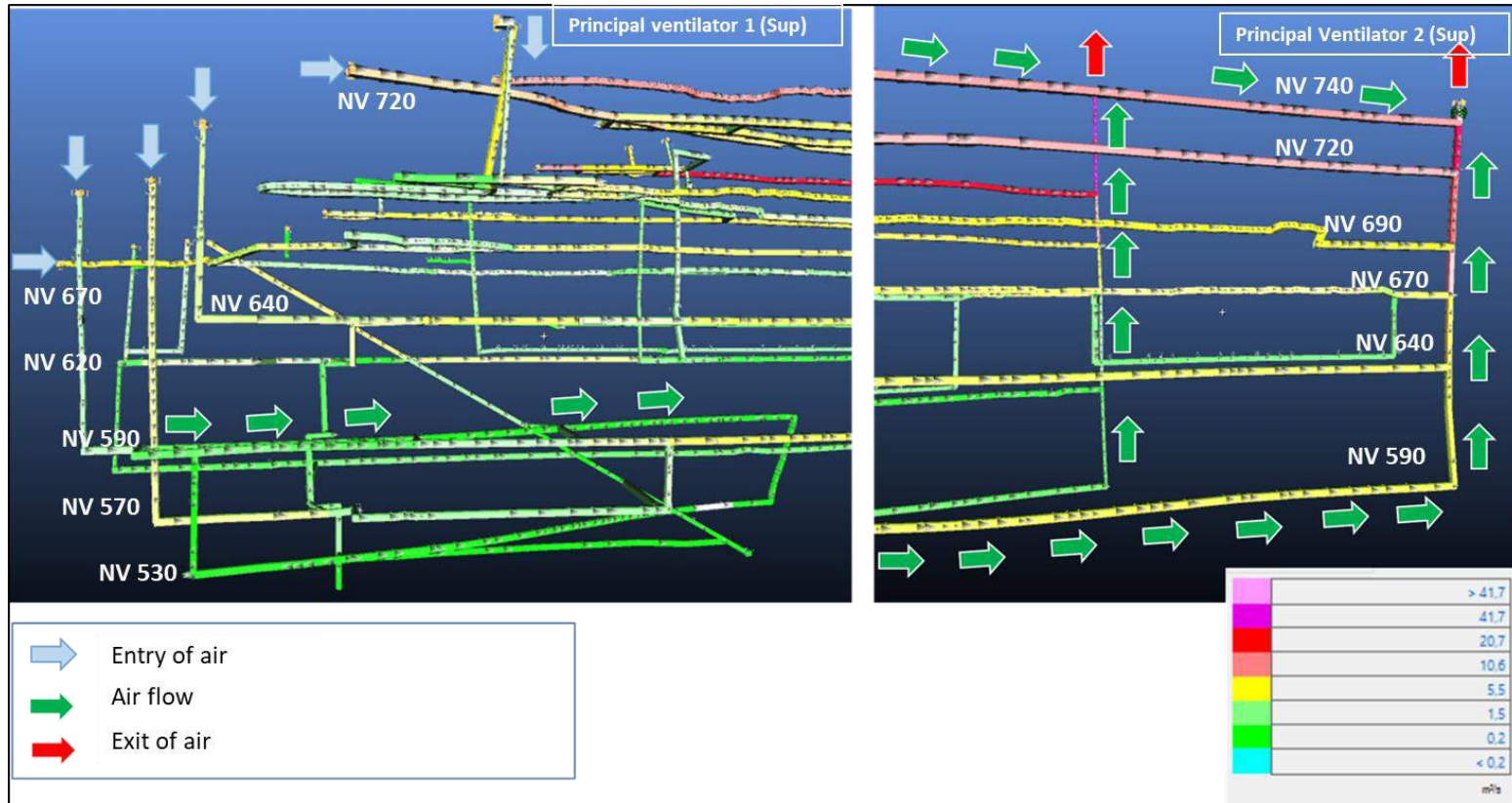

Figure 16-8: Isometric view of airflow - Ventsim. Own elaboration.

### 16.11 Pumping

Water will enter the mine workings from groundwater (via abandoned open workings and new development) and the use of water for drilling equipment. It is planned to develop a Wastewater Treatment Plant (WWTP) with a capacity of 4 l/s which is comparable to the current peak inflows based on the existing infrastructure. As the development meterage increases and the mine deepens beyond level 670 the inflows will need to be monitored and the hydrogeological characterization updated. The water will be pumped from the mine entrances to the WWTP and the requirement will be covered by the projected treatment ratio. The cost of pumping has been considered based on a typical operation with conventional cut and fill mining.

In Figure 16-8 is the schematic view of the pumping system for the Santa Elena mine.

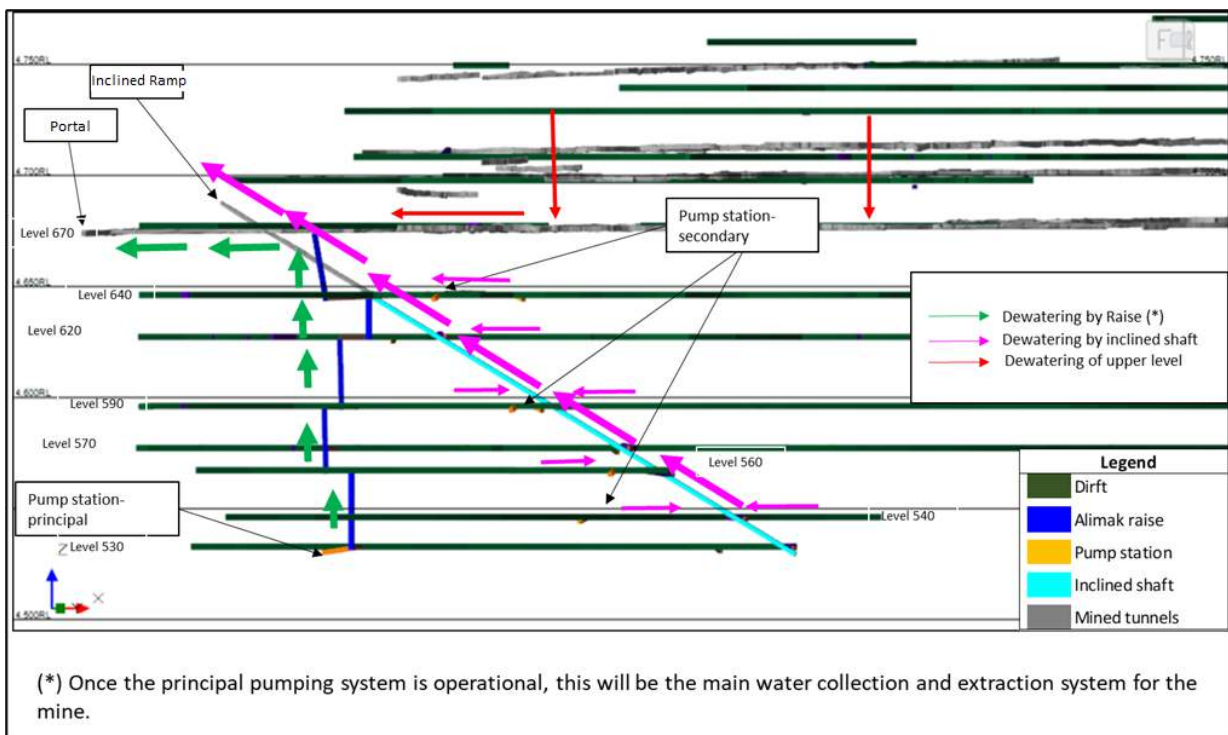

Figure 16-9: Schematic view of the pumping system. Own elaboration.

### 16.12 Auxiliary services

#### 16.12.1 Water

The water requirement for the mine will be mainly for the pneumatic drilling equipment (Jackleg and stopper). Table 16-24 shows the calculation of the water requirement during the life of the mine.

Table 16-24: Industrial water requirement

Industrial water consumption	A	Period 0	Period 1	Period 2	Period 3	Period 4	Period 5	Period 6	Period 7
Water consumption - Jackleg - m <sup>3</sup>	3.78l/min	980	6,858	5,879	4,899	4,899	4,899	3,919	-
Water consumption - Stopper - m <sup>3</sup>	3.78l/min	1,960	7,835	7,838	9,798	10,778	9,798	9,798	4,899
Others - m <sup>3</sup>	10%	294	1,470	1,372	1,470	1,568	1,470	1,372	490
<b>Total required water - m<sup>3</sup></b>		<b>3,233</b>	<b>16,166</b>	<b>15,089</b>	<b>16,166</b>	<b>17,244</b>	<b>16,166</b>	<b>15,089</b>	<b>5,389</b>

### 16.12.2 Air

The air requirement for the mine will be mainly for the pneumatic equipment (Jack leg, stopper and pneumatic shovels). In Table 16-25 the calculation of the air requirement during the life of the mine is shown, this air will be supplied by compressors 1000 CFM capacity.

Table 16-25: Air requirement

# Compressors	und	Period 0	Period 1	Period 2	Period 3	Period 4	Period 5	Period 6	Period 7
Required air - Jack leg - m <sup>3</sup> /min	4.4	8.8	30.8	26.4	22	22	22	17.6	0
Required air - Stopper - m <sup>3</sup> /min	4.4	17.6	35.2	35.2	44	48.4	44	44	22
Required air - Rocker Shovel - m <sup>3</sup> /min	9.9	29.7	-	29.7	-	-	9.9	-	-
Total required air - m <sup>3</sup> /min	19	56	66	91	66	70	76	62	22
<b>Total Air Required - CFM</b>	<b>661</b>	<b>1,982</b>	<b>2,330</b>	<b>3,225</b>	<b>2,330</b>	<b>2,486</b>	<b>2,680</b>	<b>2,175</b>	<b>777</b>

### 16.12.3 Energy

In the Table 16-26 the energy consumption per year for the electrical equipment considered for the operation is detailed.

Table 16-26: Power requirement

Mine energy consumption	Ratio	Period 0	Period 1	Period 2	Period 3	Period 4	Period 5	Period 6	Period 7
Power Consumption - Drag Winch (kw)	15 kw/equip.	15	59	88	88	88	88	103	74
Power Consumption - Hoisting Winch (kw)	261 kw/equip.	261	261	261	261	261	261	261	261
Power consumption - Fans 60 KCFM (kw)	74 kw/equip.	0	0	0	73.5	73.5	147	147	147
Power consumption - Fans 60 KCFM (kw)	37 kw/equip.	37	37	37	0	0	0	0	0
<b>Total Required Power - kw</b>		<b>312</b>	<b>357</b>	<b>386</b>	<b>423</b>	<b>423</b>	<b>496</b>	<b>511</b>	<b>482</b>

## 16.13 Mine Infrastructure Facilities

Surface mining infrastructure facilities will include:

- Hauling routes.
- Workshop.
- Fuel storage facilities.
- Magazine for explosives and accessories.



- Offices.
- Electric generators.
- Wells for mine water.
- Communications.

## 16.14 Development and Production Schedule

### 16.14.1 Development Schedule

The beginning of the development and preparation plan was projected to start from month 7 of the pre-production year, for which rehabilitation works will be carried out at levels 670, 690, 700, 740 and the inclined shaft at level 630.

The development plan considers starting at level 670, 690 and the inclined shaft. The development will be constructed in a conventional manner, due to the configuration of the mine (narrow veins). For ventilation and service chimneys, they will be carried out in a conventional manner with Jackleg and Stopper equipment.

The progress ratios are presented in Table 16-27.

Table 16-27: Mining Rate – Development and Preparations

Description	Unit	Rate
Chute	Meters per month	1.7 m/d
Raise room	Meters per month	1.7 m/d
Manway raise	Meters per month	1.7 m/d
Service raise	Meters per month	1.7 m/d
Crosscut to drift	Meters per month	1.7 m/d
Crosscut to raise	Meters per month	1.7 m/d
Drift	Meters per month	1.7 m/d
Inclined shaft	Meters per month	1 m/d
Sublevel	Meters per month	1.7 m/d

Table 16-28: Mine Development per year

Type	Lat. / Vert.	Unit	Pre Production	1	2	3	4	5	6
Development	Lateral	m	858	2,005	1,776	1,352	2,012	1,232	881
	Vertical	m	-	30	17	31	-	60	-
Preparation	Lateral	m	287	1,604	1,077	583	994	915	804
	Vertical	m	1,009	1,851	1,060	1,595	1,995	2,061	1,338
<b>Total</b>		<b>m</b>	<b>2,154</b>	<b>5,491</b>	<b>3,930</b>	<b>3,561</b>	<b>5,000</b>	<b>4,268</b>	<b>3,024</b>

### 16.14.2 Production Schedule

The annual production rate will be 350 tpd, which will be reached in year 1. To support production, 21 active mining blocks are required.

The mine plan assumes that as of month 7 of the pre-production year, the development and preparation works will begin and for this the rehabilitation works will have already been carried out.

The extraction of mineralized material will be carried out through the pass/escape way using drag winches, then by means of mining cars and locomotives it will be extracted to the surface for work above level 670. For work below level 670 the use of the inclined shaft will transfer the mineralized material to the surface. The mineralized material on the surface will be taken with 15 m<sup>3</sup> dump trucks to the concentrator plant.

The proposed mine plan is based on a 36% indicated resources and 64% inferred resources. Table 16-29 shows the annualized plan presented with the mineralized material grades and average value.

Table 16-29: Production Plan

	Year								Total
	Preproduction	1	2	3	4	5	6	7	
<b>Tonnes of mineralized material (t)</b>	40,142	125,452	126,027	126,037	126,035	126,039	126,268	61,077	857,078
<b>NSR (\$/t)</b>	306	238	207	215	241	212	181	183	218
<b>Oz/t Ag</b>	12.31	9.23	7.81	8.12	8.90	7.77	6.81	6.87	8.21
<b>gr/t Au</b>	0.15	0.16	0.19	0.21	0.25	0.24	0.17	0.22	0.20
<b>%Cu</b>	0.14	0.11	0.12	0.14	0.15	0.14	0.09	0.08	0.12
<b>%Pb</b>	2.11	2.57	2.17	2.15	2.96	2.37	1.92	2.07	2.32
<b>%Zn</b>	1.93	1.27	1.54	1.53	1.69	1.80	1.45	1.25	1.54
<b>TPD</b>	223	348	350	350	350	350	351	170	

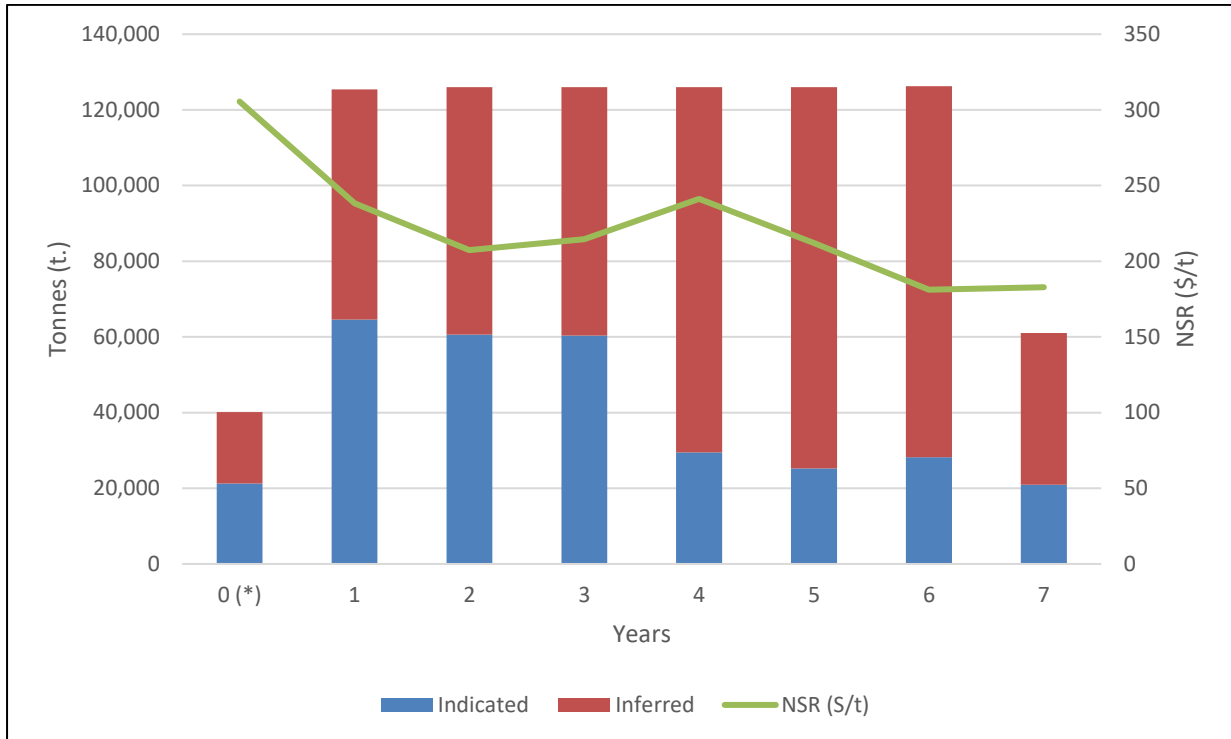

Figure 16-10: Production Plan by Category. Own elaboration.

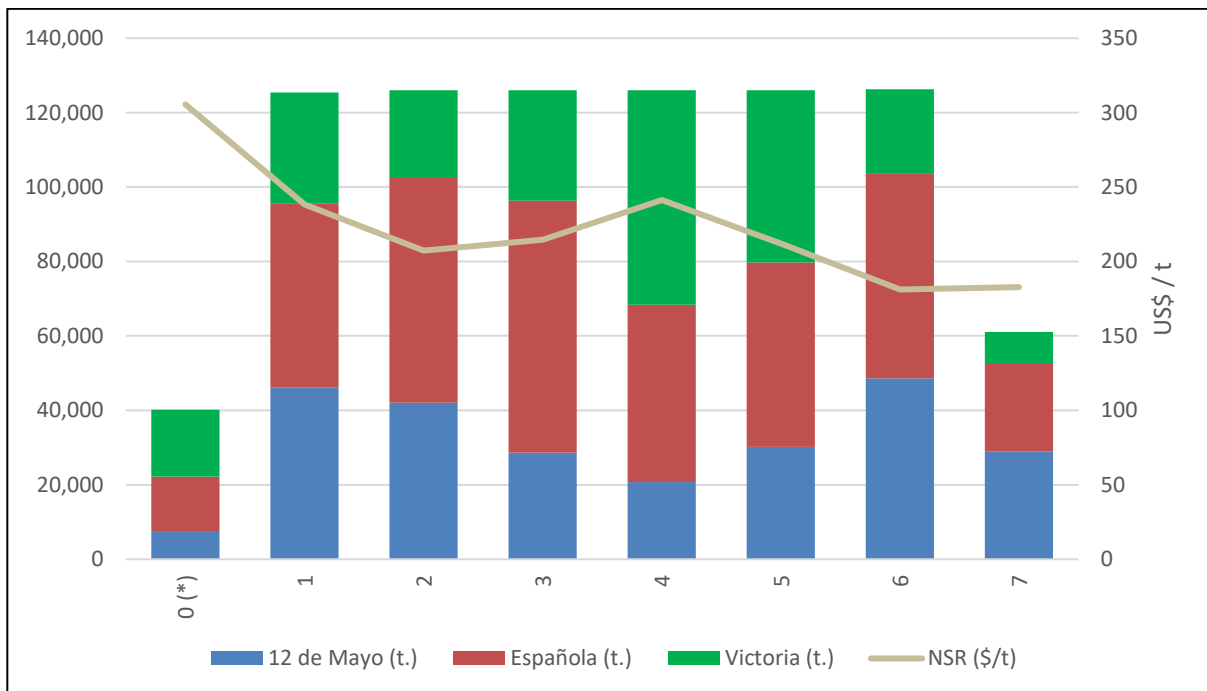

Figure 16-11: Production Plan by Zone. Own elaboration.

### 16.15 Blasting and Explosives

The drilling stage for the stopes, development and infrastructure will be carried out with Jackleg and Stopper equipment, typical equipment for conventional underground mining. For the blasting stage, dynamite and emulsion (in areas with the presence of water) will be used.

### 16.16 Grade Control

The selected mining method and design for all production zones are developed with the aim of minimizing possible dilution and allowing the greatest metal recovery. The appropriate SMU has been established for the Conventional Ascending Cut and Fill mining method. The controls will be developed with follow-up to the perforations of the stopes and the sampling of the material.

### 16.17 Mining Equipment

The mine equipment that will be required in the mining plan is summarized in Table 16-30.

Table 16-30: Mining Equipment – Mine Production

List of equipment	# of equipment per year (acquisition)							
	Pre Prod.	1	2	3	4	5	6	7
Battery locomotive (5 t)	3	-	3	-	-	1	-	-
Battery Bank	6	-	6	-	-	2	-	-
Battery charger	3	-	3	-	-	1	-	-
Mining car (1.5 t)	10	-	30	-	-	10	-	-
Surface grizzly	2							
Electrohydraulic hopper	2							
Slusher hoist (the inclined shaft) - 5t.	1							
Mining car (1.5 t) - (the inclined shaft)	1				3			
Pavement breaker	2				2			
Dump truck 15 m <sup>3</sup>	2	-	-	-	-	2	-	-
Jackleg (horizontal perf.)	2	5	-	-	5	-	-	-
Stopper (Vertical Perf.)	4	4	2	4	5	2	3	1
Slusher hoist and scraper	1	3	2	1	3	2	2	1
Rocker shovel	3	-	3	-	-	1	-	-
Installation of Rails and accessories (inclined) (m.)	41	-	124	-	69	-	-	-
Installation of Rails (Galleries) - (m.)	645	1,868	1,309	1,259	1,661	1,090	871	
Compressors	1	-	1	1	1	-	-	-

## 17 RECOVERY METHODS

---

### 17.1 General Description

The engineering design of the Minera Toro de Plata facilities was developed by the company BISA Ingeniería de Proyectos S.A. Based on the metallurgical testing and analysis described in Section 13 of this report, the plant design follows modern conventional practice. The Bethania concentrator plant will be designed to process 350 tpd of mineralized material with average head grades of 0.3% Cu, 4.0% Pb and 3.0% Zn, to produce copper concentrate, lead concentrate and zinc concentrate.

Flotation with significant silver content reagents are added to the grinding, copper, lead, and zinc flotation circuits.

A summary diagram of the overall process flowsheet is presented in Figure 17-1. The plant will use conventional technology and the following process unit operations will be used to recover copper, lead, and zinc sulfides from the Kuya mineralized material:

1. Two-stage crushing in closed circuit.
2. A single grinding and classification stage with flash flotation cell SK80.
3. One bulk flotation circuit.
4. One Lead / Copper separation flotation circuit.
5. One Zinc flotation circuit.
6. One Zinc regrinding circuit.
7. Thickening and filtration stages for lead and zinc concentrates.
8. One tailings thickener for water recovery.

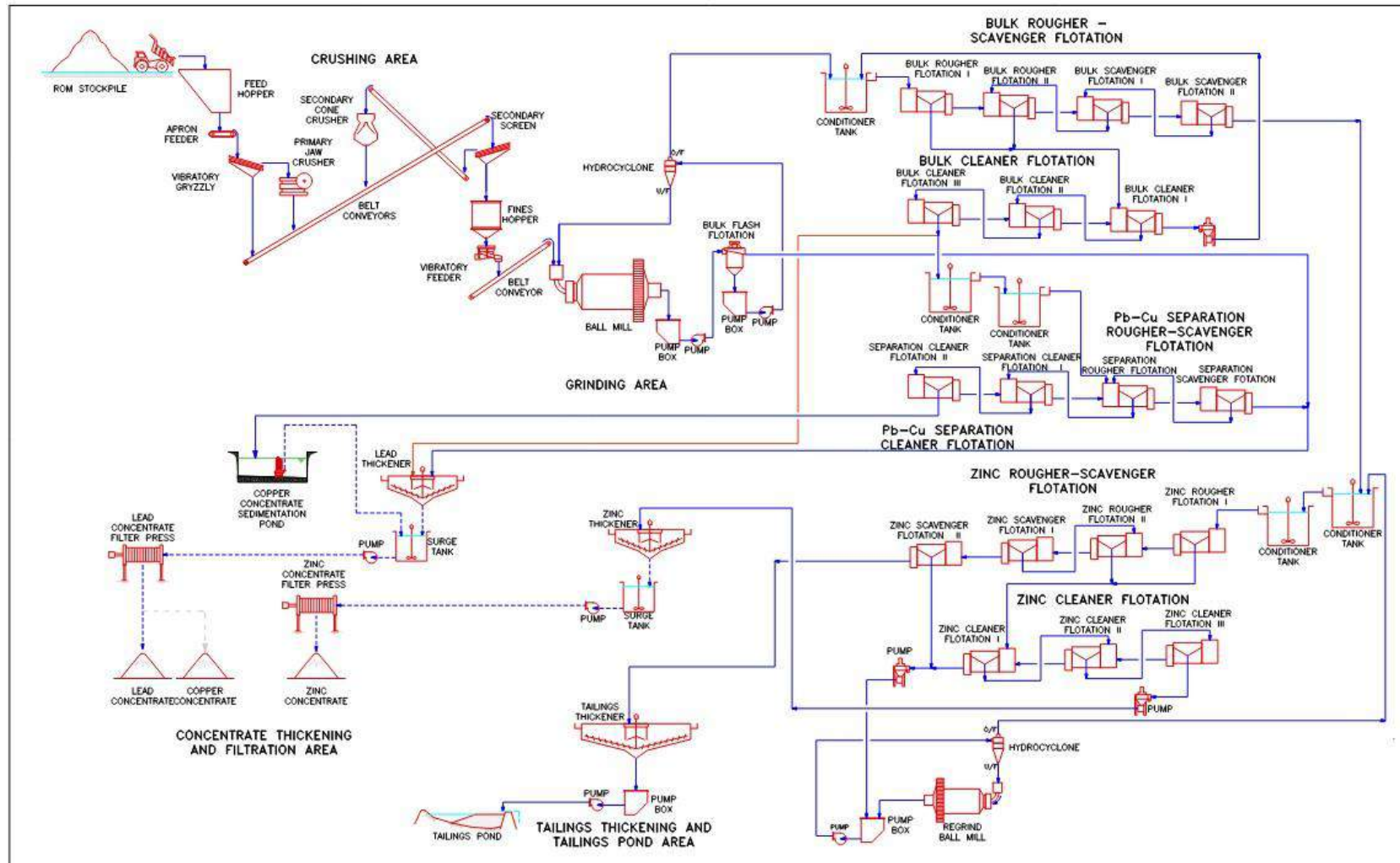

Figure 17-1: Simplified Flow Sheet (BISA Ingeniería de Proyectos S.A January 2021)



## 17.2 Process Design Criteria

Process design criteria was developed by BISA Ingeniería de Proyectos S.A. for the Project based on a 350 tpd (128 ktpy) plant design. The crushing circuit was designed to operate with an overall availability of 50% of total time. The rest of the processing facilities were designed to operate with an overall availability of 96%. The equipment was sized using the following process design criteria. Table 17-1 presents a summary of the main components of the Bethania project process design criteria used for the study.

Table 17-1: Process Design Criteria

Description	Unit	Value
<b>Mill Feed Characteristics</b>		
Specific Gravity	-	3.18
Bulk Density	t/m <sup>3</sup>	1.74
Moisture Content	%	5
Bond Ball Mill Work Index	kW-h/st	13.37
<b>Operating Schedule</b>		
Shifts/Day Crushing	-	1
Shifts/Day Grinding and Flotation	-	2
Hours/Shift	h	12
Hours/Day	h	24
Days/Year	d	365
<b>Plant Availability/Utilization</b>		
Overall Plant Feed, nominal	ktpy	128
Overall Plant Feed, design	ktpy	153
Overall Plant Feed, nominal	tpd	350
Overall Plant Feed, design	tpd	420
Crusher Plant Availability	%	50
Grinding and Flotation Plant Availability	%	96
<b>Plant Throughput (without availability)</b>		
Crushing Rate, nominal	tph	29
Crushing Rate, design	tph	35
Grinding and Flotation Rate, nominal	tph	15
Grinding and Flotation Rate, design	tph	18
Design Factor	%	1.2
<b>Plant Feed Grade (LOM)</b>		
Lead (Pb)	%Pb	4.00
Zinc (Zn)	% Zn	3.00
Silver (Ag)	oz/st Ag	15
Copper (Cu)	%Cu	0.30
<b>Recovery</b>		
Lead	%	90.12
Zinc	%	80.72
Copper	%	63.78
Silver Overall	%	92.64
<b>Concentrate Grade</b>		
Lead	%	60.00
Zinc	%	50.00
Copper	%	20.00

Description	Unit	Value
<b>Concentrate Production</b>		
Lead	tpd	21.03
Zinc	tpd	16.95
Copper	tpd	3.35

## 17.3 Process Description

### 17.3.1 Mineralized Material Reception

The mineralized material is transported by 20 to 30 t trucks from the Santa Elena mine and will be dumped directly into the hopper with a capacity of 190 t. The hopper has a stationary screen with 6" openings.

### 17.3.2 Crushing Operations

From the coarse mineralized material hopper, the mineralized material is reclaimed with an apron feeder that discharges onto a vibrating grizzly of 2' x 2 ½' with 1 ½" opening.

The undersize (U/S) that passes through the grizzly falls onto belt conveyor N°1; oversize (O/S) enters a 16" x 24" jaw crusher with 1 ½" closed side setting, the product from the crusher discharges onto belt conveyor N°1.

The belt conveyor N°1 feeds a 4' x 8' vibrating screen. The screen oversize discharges to belt conveyor No. 2 which discharges to a Ø3'-shorthead cone crusher, with a 3/8" closed side setting. The product from the secondary crusher returns to the vibrating screen on belt conveyor No. 1, closing the circuit; the final product of the crushing circuit will be approximately 80% passing 0.26" (6.6 mm).

The vibrating screen undersize is discharged through a chute directly to the 200 t capacity fines hopper. Fine crushed mineralized material is reclaimed using a vibrating feeder that discharges to an 18" wide belt conveyor N° 3 to the grinding circuit.

### 17.3.3 Grinding Operations – Classification

The crushed mineralized material is discharged from the fines hopper onto belt conveyor N° 3 to feed the 8' x 8' ball mill. Water addition and reagents are added to the primary ball mill.

The primary ball mill discharges into a pumping box and the pulp is pumped to the SK-80 flash flotation cell.

The flash flotation cell recovers a significant amount of lead present in coarse particles, the concentrate from the flash cell flows by gravity to the 10' diameter x 10' high lead thickener as the final lead concentrate and tails discharge to a pump box and will be pumped to the ball mill

D-12 hydrocyclone. The underflow from the hydrocyclone returns as a 250% circulating load to the ball mill, while the overflow (final grinding product) is sent to the flotation circuit.

Reagents used in the circuit will include lime, zinc sulphate, sodium cyanide, and A-404, A-208, and A-31 as promoters.

#### **17.3.4 Bulk Flotation Circuit**

The bulk flotation circuit consists of a conditioning stage in a 7' diameter x 8' high conditioning tank (tank No. 1), rougher flotation stage with a 2-4 arrangement, a rougher-scavenger flotation stage with a 4-4 arrangement and three cleaner stages with a 1-2-6 arrangement. The rougher flotation stage has six 50 ft<sup>3</sup> Sub A-24 cells; the tailings from the rougher bulk stage flow by gravity to feed the eight 50 ft<sup>3</sup> Sub A-24 cell scavenger stage.

The rougher concentrate is sent to the first cleaner stage consisting of six SubA - 18 Sp cells of 24 ft<sup>3</sup> each. The first cleaner flotation concentrate is sent to the second cleaner stage consisting of two SubA —18 Sp flotation cells of 24 ft<sup>3</sup> each. The second cleaner flotation concentrate is the final bulk concentrate. If the operation requires it, this concentrate can be sent to a third cleaner stage consisting of one 24 ft<sup>3</sup> SubA - 18 Sp cell, to improve the quality of bulk concentrate.

The tailings from the first bulk cleaner along with the scavenger concentrate are sent to the conditioning tank and then returned to the rougher stage. The tailings from the scavenger stage are discharged by gravity into the conditioning tank that will feed the zinc flotation circuit.

Reagents used in the circuit will include zinc sulphate, A-3894 as a promoter, xanthate Z-11 as collector, and methyl isobutyl carbinol (MIBC) and D-250 as frother.

#### **17.3.5 Pb/Cu Separation Circuit**

When the mineral contains a significant amount of copper, it is necessary to send the bulk concentrate to the flotation separation circuit (Pb-Cu), where lead concentrate and copper concentrate are obtained.

This circuit will be made up of:

1. Two conditioners (tank No. 2 and tank No. 3) of 4' diameter x 4' high operated in series.
2. One rougher stage with three —18 Sp flotation cells of 24 ft<sup>3</sup> each.
3. One rougher scavenger stage with three -18 Sp cells of 24 ft<sup>3</sup> each.
4. Two cleaner stages with one SP-18 cell each.

The arrangement of the flotation separation circuit is 3-3-1-1. The rougher concentrate Pb/Cu is sent to the first cleaner stage; the first cleaner flotation concentrate is sent to the to the

second cleaner stage. This is the final copper concentrate and is sent to a pond to remove water by sedimentation.

The rougher stage tailing is sent by gravity to the scavenger stage; scavenger concentrate returns to the rougher stage and the scavenger tailings constitute the lead concentrate, which is sent by gravity to a 10 ft diameter x 10 ft high lead thickener ahead of the concentrate filter.

### ***17.3.6 Zinc Flotation Circuit***

This circuit will be made up of:

1. Two conditioners (tank No. 4 and tank No. 5) of 8' diameter x 8' high.
2. One rougher flotation stage with six 50 ft<sup>3</sup> Sub A -24 flotation cells.
3. One rougher scavenger flotation stage with eight 50 ft<sup>3</sup> Sub A -24 flotation cells.
4. Three cleaner stages with six 24 ft<sup>3</sup> 18 Sp cells the first cleaner, two 24 ft<sup>3</sup> SubA 18 Sp cells the second one and one 24 ft<sup>3</sup> SubA -18 Sp cell the third.

The tailings from the bulk circuit feed the conditioning tanks (No.4 y No.5) ahead of the zinc flotation circuit, then it is sent to the rougher circuit.

The zinc rougher concentrate is sent to the zinc first cleaner stage, the first cleaner flotation concentrate is sent to the second cleaner stage. The second cleaner flotation concentrate is sent to the third cleaner stage, and the concentrate of this last cleaner is sent to the 10' diameter x 10' high zinc thickener.

The zinc rougher tailings are sent by gravity to the zinc rougher scavenger stage. The scavenger concentrates and the tailing from the first cleaner stage are sent to the regrind circuit. With a pump of 2 ½" x 36", the pulp is sent to the hydrocyclone; the underflow returns to the regrind ball mill (6' x 6') and the overflow goes back to the rougher flotation.

The tailings from the scavenger stage constitute the final tailings that are sent to the 20' diameter x 10' high tailings thickener. The 60% solids thickener underflow is pumped to the tailings storage facility and the thickener overflow is pumped to the reclaimed water tank.

Reagents used in the circuit will include lime, copper sulphate, xanthate Z-11 and frother MIBC.

### ***17.3.7 Concentrates Dewatering***

#### ***17.3.7.1 Lead Concentrate Dewatering***

The flash cell concentrates, and lead concentrate produced in the bulk separation circuit will be sent to the 10'x 10' lead thickener. The thickener underflow at ~53% solids is pumped into the holding Tank N ° 1; then the concentrate is fed through a pump to a filter press with twenty 600 mm x 600 mm plates. The filtered concentrate will have an approximate moisture of 9 to 10%.

#### ***17.3.7.2 Zinc Concentrate Dewatering***

The final concentrate from the zinc flotation circuit is fed to a 10' x 10' thickener. The thickener underflow at 58% - 60% solids is pumped into the holding Tank N ° 2; then the concentrate is fed through a pump to a filter press with twenty 600 mm x 600 mm plates. The filtered concentrate will have an approximate moisture of 9 to 10%.

#### ***17.3.7.3 Copper Concentrate Dewatering***

The lead concentrate filter may also be used intermittently to produce copper concentrate.

The copper concentrate is sent by gravity to the sedimentation pond, the overflow from the pond is pumped to the recovered water tank.

Every week the copper concentrate from the sedimentation pond, with 50% - 58% solids is pumped into lead holding tank No. 1 (400-TK-001).

From the holding tank, the copper concentrate is pumped to the lead filter press. The filtered concentrate will have an approximate moisture of 9%.

#### ***17.3.8 Tailings thickening***

The flotation circuit tailings will be sent to a Ø20' x 10' thickener. The thickener underflow with 55% - 60% solids is sent by gravity to the tailings storage facility for sedimentation. The recovered water (overflow) from the thickener is pumped into the recovered water tank.

#### ***17.3.9 Water supply***

##### ***17.3.9.1 Fresh Water Supply***

The fresh water will be collected from a point on the Thanua river, from where it will be pumped into the freshwater storage tank. Fresh water will be distributed to the firefighting system, preparation of reagents and the drinking water treatment plant.

The freshwater requirement for the Bethania process plant is 1.68 m<sup>3</sup>/h.

##### ***17.3.9.2 Process water***

The sources of reclaimed (process) water will be the overflow from the tailings thickener and the concentrate thickeners and the water reclaimed from the tailing pond. Process water will be collected in a process water tank at the process site.

Process water will be distributed through a pipeline to mill process water usage points including hose stations of all process areas, dust suppression, grinding, flotation and filtration stage.

### ***17.3.10 Air supply***

Plant air will be distributed to crushing, grinding, flotation, thickening, and filtration areas. Plant air will be supplied by two compressors (one operating and one standby), air receivers will be installed to provide air storage. Two low pressure blowers (one operating and one standby) will supply air to the flash flotation cell.

Two compressors (one operating and one standby) followed by an air dryer will provide instrumentation air to be distributed to the instruments in the plant, and to the Ball Mill grease system. The rest of the flotation cells are sub-aerated.

The concentrate filter packages will come with their own compressors to supply air to their equipment and instruments.

All blowers and compressors are equipped with inlet filters to keep dust out of the environment.

### ***17.3.11 Auxiliary systems***

Auxiliary systems, such as reagent storage and preparation facilities, mechanical and electrical maintenance workshops, chemical and metallurgical laboratory, offices, powerhouse, general substation, etc., are listed, but not necessarily detailed in this study.



## 18 PROJECT INFRASTRUCTURE

---

Before S&L Andes Export (now Kuya) started historical operations, the company was owned by SANSIL S.R.L. who developed the mining operations and built most of the existing infrastructure and existing waste dumps. To date, Kuya’s involvement in the Property has been to advance exploration activities and the development of property-wide environmental permits in order to fast-track the Property, thus reducing the time span between permit approval and the restart of operations.

The infrastructure (existing and proposed) has been permitted using two separate environmental instruments; (1) an Environmental Impact Declaration (“DIA”) and modifications which has been used to obtain the construction and operation license to permit the mining operation (existing underground mine and associated infrastructure); and, (2) an semi detailed Environmental Impact Assessment which has been used to permit a process plant, tailings storage facility (“TSF”) and associated infrastructure. The timeline and status of the above-mentioned environmental instruments is detailed in Section 20.

The underground mine and associated infrastructure (Santa Elena concession) are located separate to the location approved for the process plant and TSF (Bethania Plant Beneficiation Concession) as shown in Figure 18-1. For the purpose of the Report, the underground mine and associated infrastructure are referenced as “Area 1” (approved DIA and modifications – Santa Elena concession) and the process plant, TSF and associated infrastructure is referenced as “Area 2” (approved EIAsd – Bethania Plant Beneficiation Concession), and with “project infrastructure” referring to the combined Area 1 and Area 2.

Note that the Beneficiation Concession area has been approved within the EIAsd but has yet to be officially registered by the MEM, this is in process.

Note that layout and engineering work done to date was undertaken to support the permitting process. Kuya took a strategic decision in selecting a 350 tpd process capacity when they started the permitting process as this was the maximum allowable tonnage permissible for a small mining producer (PPM) which Kuya was when they applied for the EIAsd.

Minor adjustments to the existing permitted designs can be made through the existing environmental instruments as long as they do not generate greater environmental impact than those already permitted (see Section 20).

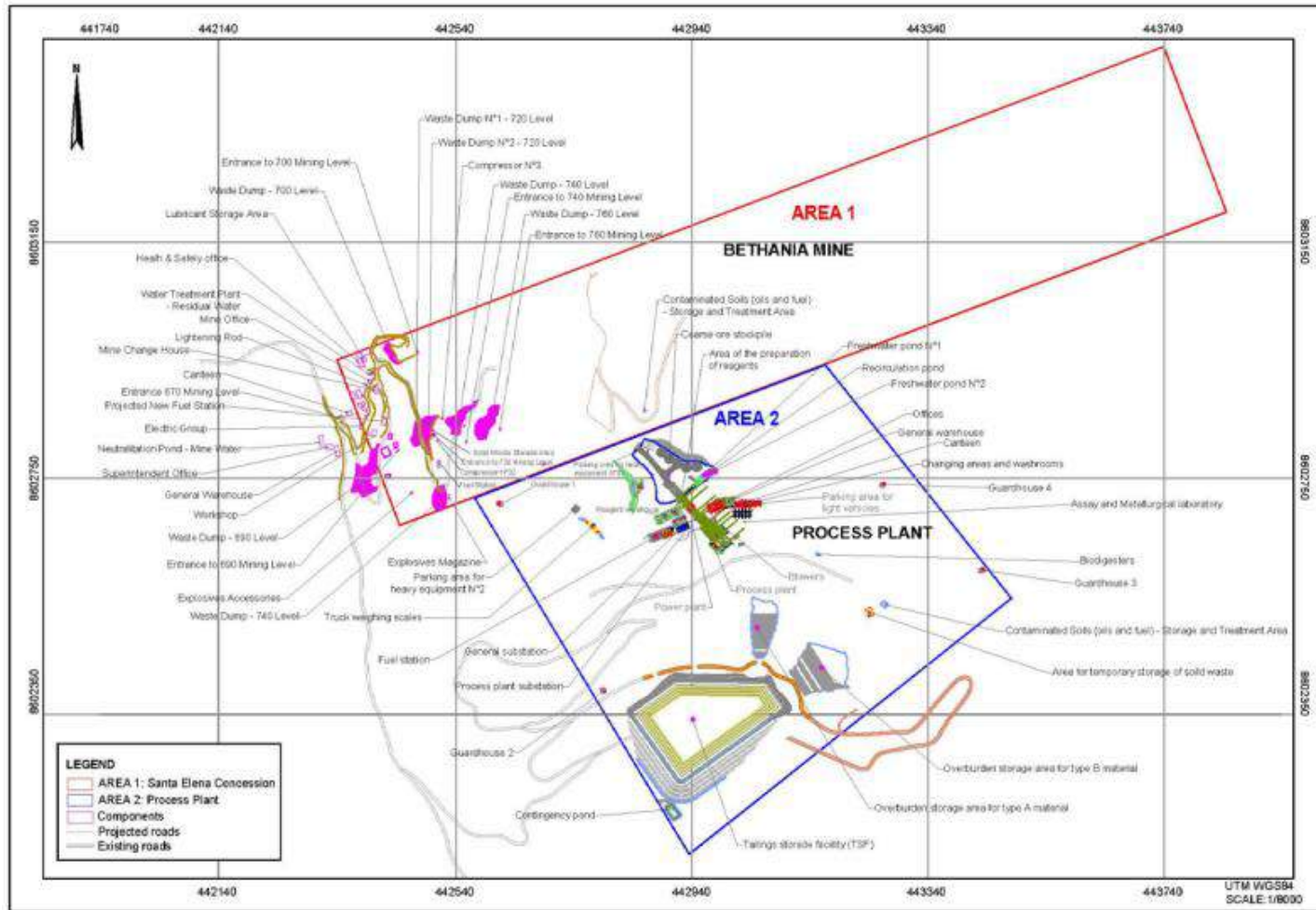

Figure 18-1: Location map showing Area 1 - Santa Elena Mining Concession, and Area 2 – Plant Beneficiation. Adapted from “NI 43-101 Technical Report & Mineral Resource Estimate” by Caracle Creek International Consulting Inc. February 21st, 2022.

### 18.1 Area 1 - Existing & Proposed Mine Infrastructure

The existing mine area of the Property has a relatively small surface footprint, most of which is located within the western quadrant of the Santa Elena mining concession as shown in Figure 18-2.

The infrastructure comprises:

- Dirt roads of varying conditions connect mining levels, waste dumps and fixed infrastructure.
- Mine entrances for levels 760, 740, 720, 700, 690 and 670.
- Waste dumps on levels 760, 740 (2 separate dumps), 720 (2 separate dumps), 700 and 690.
- Explosive magazine and a separate area for storing of blasting accessories.
- Generator group (500 KWH capacity).
- Two areas for compressors sited to support ventilation and drilling.
- Fuel storage tank with fuel distribution system.
- Solid waste storage area, lubricant storage area, general workshop and general warehouse.
- Offices, health and safety, mine planning, mine change house, lunchroom and superintendent office.
- Water neutralization pond to treat acid water drainage.

The above-mentioned infrastructure is what the mine required for historic mining, with the final product toll treated in various offsite process plants.

A modification to the existing environmental instrument (DIA) has been lodged with the relevant local authorities (DREM – Huancavelica) to approve the following changes to the infrastructure:

- New fuel station project: storage and distribution area.
- Water treatment plant for residual water.
- Contaminated soils (oils, fuel) storage area.

In addition to the mine infrastructure, Kuya also occupies a house within the town of Bethania. This house was used to support the 2021 exploration activities and will continue to be used until all new project infrastructure has been put in place or to October 2023 when the current agreement runs out. This is not considered as project infrastructure as it is situated in the town of Bethania.

Approval of the modified DIA will provide Kuya with the means to start rehabilitation of the underground workings and changes to surface infrastructure.

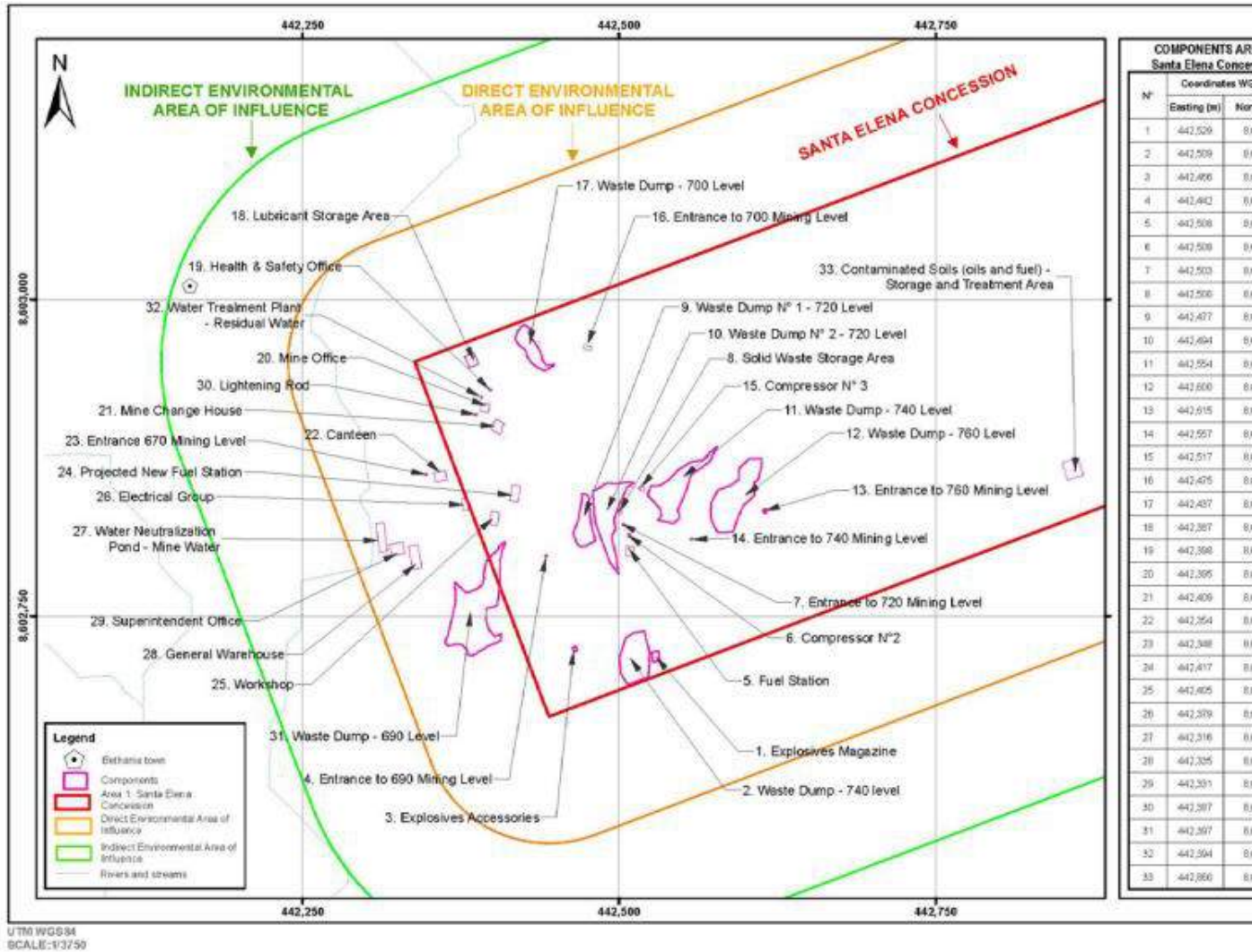

Figure 18-2: Location and proposed location (DIA modification) of Area 1 infrastructure. Adapted from “NI 43-101 Technical Report & Mineral Resource Estimate” by Caracle Creek International Consulting Inc.

Most of the existing buildings will require modification or replacing. Considering this, a gap analysis was undertaken by Mining Plus in June 2021. In addition, engineering design of the Bethania Mine was started in January 2021, although further studies are pending which include rehabilitation of the existing mine infrastructure.

The existing mine infrastructure in Area 1 along with proposed new infrastructure components are shown in Figure 18-2.

The following sub-sections provide a general description of the existing infrastructure and modifications under approval through the DIA instrument.

**18.1.1 Roads & Drainage**

Facilities at the Bethania Mine are connected via unpaved roads that are being maintained by Kuya under care and maintenance conditions. Roads have been constructed considering a

width of 4.0 meters. When the Property was in operation, water was applied to the roads during the dry season to reduce dust pollution. Kuya staff indicated that this practice is not required permanently due to current reduced activities.

The control of runoff water is managed through a network of ditches (alongside roads) crowning channels and culverts. Additionally, there will be a guarantee on the management of contacted and uncontacted waters.

### ***18.1.2 Mine Accesses and Underground Development***

The five mine accesses and underground workings need to be rehabilitated (level 670, 690, 700 740 and the 630 incline). Section 16, Mining Methods, presents a general description of existing condition and the future mine plan.

### ***18.1.3 Mine Waste dumps***

The Property currently has seven waste dumps that were used historically to store waste rock generated through development of the mine. Kuya plan to store the majority of any new waste rock as backfill within the underground mine workings to reduce the amount to be stored on surface. Waste rock material that needs to be brought to surface will be incorporated into the existing waste dumps.

The mine waste dumps currently show physical and chemical stability.

### ***18.1.4 Explosives Magazine and Accessories***

The Property has an explosive magazine and a store for explosive accessories (both currently not in use) which supported previous production. Due to changes in current regulations, both of these structures will require relocation. This was not considered in the modified DIA application. A further update to the DIA will be required to include this new modification.

### ***18.1.5 Mine Power and Distribution***

Kuya manage the onsite power supply via two Diesel Generator Sets with 125 kW (CAT D343125kW) and 154 kW (Xylene) capacity. The Xylene 154 kW Diesel Generator set has a switchboard located next to the mine access level. The CAT D343125 kW diesel generator set supplies the energy demand of the Bethania community and the house that it rents in the town.

To develop the mining plan at 350 tpd, the energy requirement is 511 kW as the maximum requirement for the operation, for which it would be necessary to have 3 additional 154 kW generators to cover the requirement.



The mine has a secondary reserve power supply generator station which also operates at 154 kW. The reserve generator is used in case of power failure in the primary generator and/or when maintenance to the primary generator is required.

#### ***18.1.6 Compressors***

Two separate sites exist for compressors (Diesel Compressors Atlas Copco XAMS 160Dd with capacity of 850 CFM and Diesel Compressor Ingersoll Rand with a capacity of 750 CFM, size is 4.4x1.7x1.6 m). Location of the compressors can be seen in Figure 18-2. The compressed air requirement for the 350 tpd mine plan is 3,200 CFM, so it would be necessary to increase the compressor equipment, 1 compressor with capacity of 850 CFM and another compressor with capacity of 750 CFM.

#### ***18.1.7 Fuel Storage Tank and Distribution***

One area (16 m<sup>2</sup>) exists for fuel storage and distribution. The fuel storage area is for diesel fuel only and has a capacity to store 900 litres of fuel. This was sufficient for the historic operation.

A new fuel storage area is included in the modified DIA. The new fuel storage and distribution area will have the same capacity as the original.

#### ***18.1.8 Storage Areas, Workshops and Warehouses***

Storage areas exist for the stowing of solid waste and lubricants. The solid waste storage area is located below the entrance to the 720 mining level and comprises an area of approximately 272 square meters.

Lubricants are stored in a galvanized structure located beside the mine office. The lubricant storage infrastructure covers an area of 73 square meters.

The general workshop has been constructed using drywall and is centrally located, it covers an area of 136 square meters.

The general warehouse is a galvanized structure situated beside the mine superintendent office. It covers an area of 48 square meters.

#### ***18.1.9 Offices, Changing Rooms, and Canteen***

The following infrastructure exists to manage and provide mining services for the mine:

- Health and safety office, area of 27 m<sup>2</sup>, galvanized construction with galvanized roof.
- General mine office, area of 43 m<sup>2</sup>, galvanized construction with galvanized roof.
- Mine superintendent office, area of 95 m<sup>2</sup>, galvanized construction with galvanized roof.



- Mine change house, area of 74 m<sup>2</sup>, galvanized construction with galvanized roof.
- Lunchroom, area of 68 m<sup>2</sup>, galvanized construction with galvanized roof.

#### **18.1.10 Water Storage and Water Treatment**

The DIA modification incorporated a water treatment plant considering a flow of four litres per second that comes from various mine level accesses. The process proposed in the modified DIA consists of a convergence and conditioning structure through which lime slurry and chlorine is injected to modify the water pH, this is followed by adding flocculant reagent to aid in the settlement of sediments. The water will then pass to a settling tank where the sludge is separated from the clarified water. The sludge is then passed to a platform to dry before being stored in containers before final disposal by a licensed contractor. The clarified water continues to a second filtering process to remove any remaining sediment. The water that exists the second filtering process continues to the treated water pool and discharge.

#### **18.1.11 Contaminated Soils (oils, fuel) Storage Area**

The DIA modification incorporated an area (225 m<sup>2</sup>) for the storage and treatment of soils contaminated with hydrocarbons with the objective of reducing the overall hydrocarbon concentration to less than 1000 parts per million.

#### **18.1.12 Conclusion - Mine Infrastructure**

With approval of the modified DIA, Kuya will be able to initiate the rehabilitation of the underground workings. A further modification of the DIA will be required to move the explosives magazine and accessories as the current location is no longer permitted under new legislation (it is too close to other infrastructure).

Kuya will evaluate what other modifications are required as it progresses with detailed engineering. The current magazine has valid permits but due to its size increases the rotation required for restocking. The objective is to incorporate all possible changes into a new DIA modification.

### **18.2 Area 2 – Beneficiation Concession - Layout Design and Engineering**

Various consulting companies developed the project layout and engineering designs needed to support the siting of a process plant, TSF and supporting infrastructure for permitting purposes, these included:

- Process Plant: Conceptual Engineering - SICG SAC (2019 to present).
- TSF Design “E2E” – DICAT (December 2019 to present).
- Geotechnical Study: TSF, Concentrator Plant, Water Treatment Plant and Roads – Sotelo & Asociados in (September to October 2020).

- Process Plant – BISA Ingeniería de Proyectos S.A (January 2021 to present).

The general components of the process plant and TSF approved in the EIAAs consists of the following:

- Process plant.
- Tailings Storage Facility (TSF).
- Access road and connecting road network.
- Coarse mineralized rock stockpile.
- Overburden storage areas.
- Freshwater ponds (two), recirculation pond and contingency pond.
- Power plant, process plant sub-station, general substation.

No infrastructure exists in the area for the proposed process plant apart from 2.0 km of dirt roads that pass through the general area. Figure 18-3 shows the EIAAs approved location of Area 2 infrastructure.

### **18.2.1 Process Plant**

The approved area for the process plant consists of an area of 3,148 m<sup>2</sup> and includes primary and secondary crushing, milling and classifying, differential Pb, Zn and Cu flotation, a gravity circuit, filtration and tailings thickening.

The preliminary proposed concentrator design and siting is discussed in Section 17, Recovery Methods.

### **18.2.2 Tailings Storage Facility - TSF**

#### **18.2.2.1 Tailings Management**

The Bethania project tailings facility was designed by the Technical Office of the Department of Civil Engineering (DICAT) of the Universidad Católica de la Santísima Concepción (UCSC).

The tailings facility has been designed to store a total of approximately 750,000 t (458,000 m<sup>3</sup>) of tailings, to be processed at a nominal rate of 350 tpd. This is based on a total Life-of-Mine of approximately 6 years.

The Tailings Facility (TF) has been designed as a dam storage, acting as containment set against the natural terrain. The design concept includes for the excavation of approximately 100,000 m<sup>3</sup> of soil and rock, in order to create sufficient capacity for the total volume of tailings to be produced. The excavated soil and rock will, partially, be re-used as fill material in the constructed dams. The dam has been planned to be constructed in 2 stages, and the basin area will be lined with a low-permeability HDPE liner material. A representative section of the TF is shown in Figure 18-3.

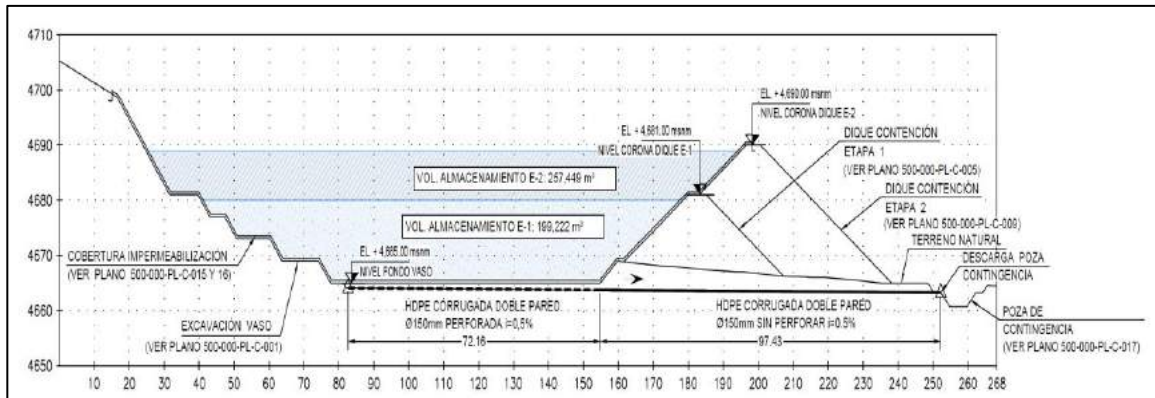

Figure 18-3: Representative Section – Bethania Tailings Facility (UCSC 2021)

As seen in the figure, the tailings facility Stage 1 capacity would be 199,222 m<sup>3</sup>; the Stage 2 capacity would be 257,449 m<sup>3</sup>. The maximum final height of the dam would be approximately 25 m.

The TF dam has been designed to be stable and within acceptable deformation tolerances, according to applicable Peruvian guidelines and standards. The liner will significantly limit potentially contaminating seepage and, additionally, the design includes for a sub-liner drainage system, which would capture and collect minor seepage from defects in the liner system. The seepage would be conducted to a Contingency Holding Pond, where it would be tested prior to release to the environment, if it meets required discharge limits; in the event that it does not meet discharge limits, it will be treated prior to discharge.

#### 18.2.2.2 Tailings Thickening, Transportation, Discharge

Tailings from the Process Plant will be thickened, to recover water at the Plant and to reduce the quantity of water stored within the TSF. The tailings will be thickened to a nominal solids content of 60% by weight.

After thickening, the tailings will then be transported via a pumping-HDPR pipeline system to the TF. The design includes for 2, parallel tailings pipelines; at any one time, transportation will be through only one pipeline, and the other will be kept in reserve either as a contingency backup, or as an alternate pipeline during maintenance or repairs of the principal pipeline.

#### 18.2.2.3 Surface Water Management

As seen in the Figure 18-4, non-contact water from areas up-slope of the TF will be diverted around the facility via surface water channels.

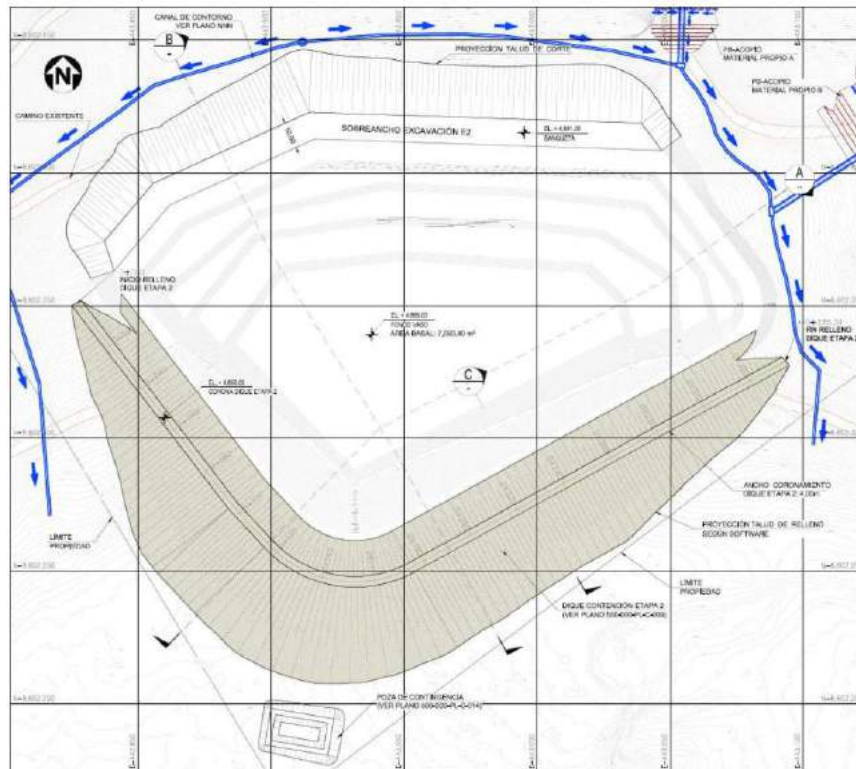

Figure 18-4: non-contact water from areas up-slope (UCSC 2021)

**18.2.2.4 Monitoring and Instrumentation**

The dam will be instrumented, in order to monitor key geotechnical and environmental risk aspects. The instrumentation to be installed would include:

- Four piezometers – Casagrande type (two piezometers located in the dam - stage 1 and two piezometers in the dam - stage 2).
- Four piezometers – vibrating wire type (two piezometers located in the dam - stage 1 and two piezometers in the dam - stage 2). Four topography control points.
- Two accelerographs (will be relocated between stage 1 and stage 2).
- One inclinometer (will be relocated between stage 1 and stage 2).

## 19 MARKET STUDIES AND CONTRACTS

---

### 19.1 Market studies

The Santa Elena mine will produce polymetallic concentrates typical of the area, where Ag, Pb, Zn and Cu Concentrates will be produced, as well as secondary Au products. It is considered that these types of concentrates are marketable due to the demand from industries that consume these metals.

Considering this, Kuya Silver has commissioned Stonehouse Consulting Inc. to produce a concentrate sales report "Bethania Concentrate Marketing Report, November 2021", which is aligned with the current marketing standards.

Concentrate market terms and conditions are a specialized business requiring knowledge of supply and demand of smelter capacity and concentrate types, as well as the terms and conditions of refineries/smelters for different quality of concentrate.

Edgard Vilela considers it reasonable to use Stonehouse Consulting Inc. for the marketing information on concentrates contained within the abovementioned document. The report has been reviewed and is suitable for the use within the PEA.

#### 19.1.1 Concentrates

The concentrates to be produced are Pb, Zn and Cu, with by-products of Ag and Au.

The production of lead concentrate and plant at the Santa Elena mine will be approximately 7,600 t/year. The product can be characterized as a high-grade lead concentrate with a significant amount of silver, the gold content is at a payable level. In Table 19-1 results for Pb concentrate are presented.

*Table 19-1: Pb Concentrate Results*

Pb concentrate		
Element	unit	test
Pb	%	60
Ag	opt	200
Au	gpt	4.9
Zinc	%	5
Cu	%	0.7
As	%	0.92
Sb	%	2.7
SiO <sub>2</sub>	%	11.88
Bi	%	0.02
Hg	ppm	
Cl	ppm	
F	ppm	

The Pb recovery standard in Pb Concentrate is between 50% - 70%, according to the information presented by Kuya Silver, 60% is being considered. This allows defining that the Pb recovery value is within the standard.

The production of zinc concentrate at the Santa Elena mine will be approximately 6,200 t/year. The zinc concentrate will contain 50% zinc grade with payable silver and gold. In Table 19-2 the results for Zn concentrate are presented.

*Table 19-2: Zn Concentrate Results*

Zn concentrate		
Element	Unit	Assays
Zn	%	50
Ag	gpt	5.12
Au	gpt	2.1
Pb	%	3
Cu	%	0.65
Fe	%	7.54
Hg	ppm	390
SiO <sub>2</sub>	%	15.95
As	%	0.21
Sb	%	0.3
Cd	ppm	
C	ppm	
F	ppm	
Se	ppm	
Mn	ppm	



The Zn recovery standard in Zn Concentrate is between 50% - 60%, according to the information presented by Kuya Silver, 50% is being considered. This allows defining that the Pb recovery value is within the standard.

The expected volume of copper concentrate is 1,200 t/year. The copper concentrate will be low/medium grade copper, with a significant amount of payable silver and gold. The impurity specification will not be known until the metallurgical test work is completed. In Table 19-3 the results for Cu concentrate are presented.

*Table 19-3: Cu Concentrate Results*

Cu concentrate		
Element	Unit	Assay
Cu	%	20
Ag	opt	180
Au	gpt	5
Pb	%	3.08
Zn	%	6
As	g/t	
Cl	g/t	
F	ppm	
Hg	ppm	
Cd	ppm	
Sb	ppm	

The results of metallurgical tests and on which the estimate of payables and deductibles is developed, and is described in section 13.

### 19.1.2 Metal Price

In Table 19-4 the projected metal prices for each element are presented.

*Table 19-4: Metal prices*

Metal	Units	Price
Pb	US\$/T	1,982.0
Zn	US\$/T	2,659.0
Cu	US\$/T	7,971.0
Ag	US\$/oz	25.4
Au	US\$/oz	1,850.0

### 19.1.3 Payable and Deductible

In the Table 19-5 the projected payables and deductibles for each item are presented, which are within the marketing standard.

Table 19-5: Payable and deductible for each metal

Payable		% P	Deduction
Cu	%	96.5%	1.1%
Zn	%	85.0%	8%
Pb	%	95.0%	3.0%
Ag en Pb Conc	%	95.0%	50.0
Ag en Cu Conc	%	90.0%	92.0%
Au en Pb Conc	%	95.0%	1.0
Au en Cu Conc	%	92.0%	-

#### 19.1.4 Metallurgical Recovery

In the Table 19-6 the projected payables and deductibles for each element are presented, which have been developed in section 17.

Table 19-6: Metallurgical recovery by element

Metal	Met Rec
Pb	90.1%
Zn	80.7%
Cu	63.8%
Ag inc Pb	80.1%
Ag inc Cu	11.5%
Au inc Pb	29.4%
Au inc Cu	4.8%

#### 19.1.5 Treatment Cost

In the Table 19-7 the projected treatment costs for each element are presented, the treatment, refining and sale costs are within the applicable standard for the concentrates to be marketed.

Table 19-7: Costs of treatment, refining and sale

Commercial terms			
Treatment Cost	Cu	240	US\$/Ton Conc
	Pb	260	US\$/Ton Conc
	Zn	330	US\$/Ton Conc
Refining Cost	Cu	0.08	US\$/lb
	Ag (Conc Cu)	0.5	US\$/oz
	Ag (Conc Pb)	1	US\$/oz
	Au (Conc Cu)	5	US\$/oz
	Au (Conc Pb)	10.00	US\$/oz
Sale Cost	Copper	157.44	\$/dmt of conc
	Lead	157.44	\$/dmt of conc
	Zinc	157.44	\$/dmt of conc

**19.1.6 Penalties**

In the Table 19-8 the projected penalties are presented for each element, they are within the applicable standard.

*Table 19-8: Penalties by element and concentrate.*

Penalties				
Pb concentrate		Max	\$	To each
As	%	0.30%	2.5	\$ each/0.1%
As	%	0.70%	5	\$ each/0.1%
Sb	%	0.30%	2	\$ each/0.1%
Zn concentrate		Max	\$	
Fe	%	8.00%	2	\$ each/1%
Hg	ppm	100.00	2	\$ each/10ppm
Si	%	3.00%	2	\$ each/1%
As	%	0.30%	2	\$ each/0.1%
Sb	%	0.30%	2	\$ each/0.1%
Cu concentrate		Max	\$	
Zn + Pb	%	3.00%	3	\$ each/1%
Zn + Pb	%	6.00%	5	\$ each/1%
As	%	0.20%	3	\$ each/0.1%
As	%	0.50%	6	\$ each/0.1%
Sb	%	0.20%	2	\$ each/0.1%
Hg	ppm	20.00	3	\$ each/10ppm

The values projected for commercialization require that they be complemented with information on the levels of contaminants of:

**For Copper Concentrate:**

- Cadmium (Cad).
- Carbon (C).
- Fluorine (F).
- Selenium (Se).
- Manganese (Mn).

**For Zinc Concentrate**

- Cadmium (Cad).
- Carbon (C).
- Fluorine (F).
- Selenium (Se).
- Manganese (Mn).

**For Copper Concentrate**

- Arsenic (As).
- Chlorine (Cl).
- Fluorine (F).
- Mercury (Hg).

## 20 ENVIRONMENTAL STUDIES, PERMITTING AND SOCIAL OR COMMUNITY IMPACT

---

### 20.1 Introduction

Mining Plus has developed the Review of the existing environmental studies, current environmental permits and the environmental and social impacts identified in previous Environmental Management Instruments (IGAs) belonging to Kuya is Kuya Silver (Kuya). It is important to note that the underground mine and associated infrastructure (Santa Elena concession) are located separately from the approved location for the processing plant and TSF (Bethania Plant Beneficiation Concession), see Figure 20-1.

Area 1: Corresponds to the area where the underground mine and associated infrastructure is located, which has its environmental permit through the approved DIA and modifications – Santa Elena concession:

- Environmental Impact Statement (DIA) of the "Santa Elena" exploration and exploitation project (DIA, 2009); approved through Regional RD No. 102-2009-DIA.
- Update of the Environmental Impact Statement of the Santa Elena Mining Concession (ADIA, 2017), approved by Regional RD No. 103-2017/GOB.REG-HVCA/GRDE-DREM dated July 31, 2017.
- Supporting technical report (ITS) of the Environmental Impact Statement (DIA-2009) and update of (DIA -2017); approved by Regional RD No. 005-2021/GOB-REG-HVAC/GRDE-DREM.

Area 2: Corresponds to the area where the process plant, TSF and associated infrastructure are located, which has its environmental permit through the approved EIAsd – Concession for the Benefit of the Bethania Plant:

- Semi-detailed Environmental Impact Study of the Benefit Concession Project "Planta Bethania" (EIAsd, 2019); approved through Regional RD No. 005-2019/GOB-REG-HVCA/GRDE-DREM.

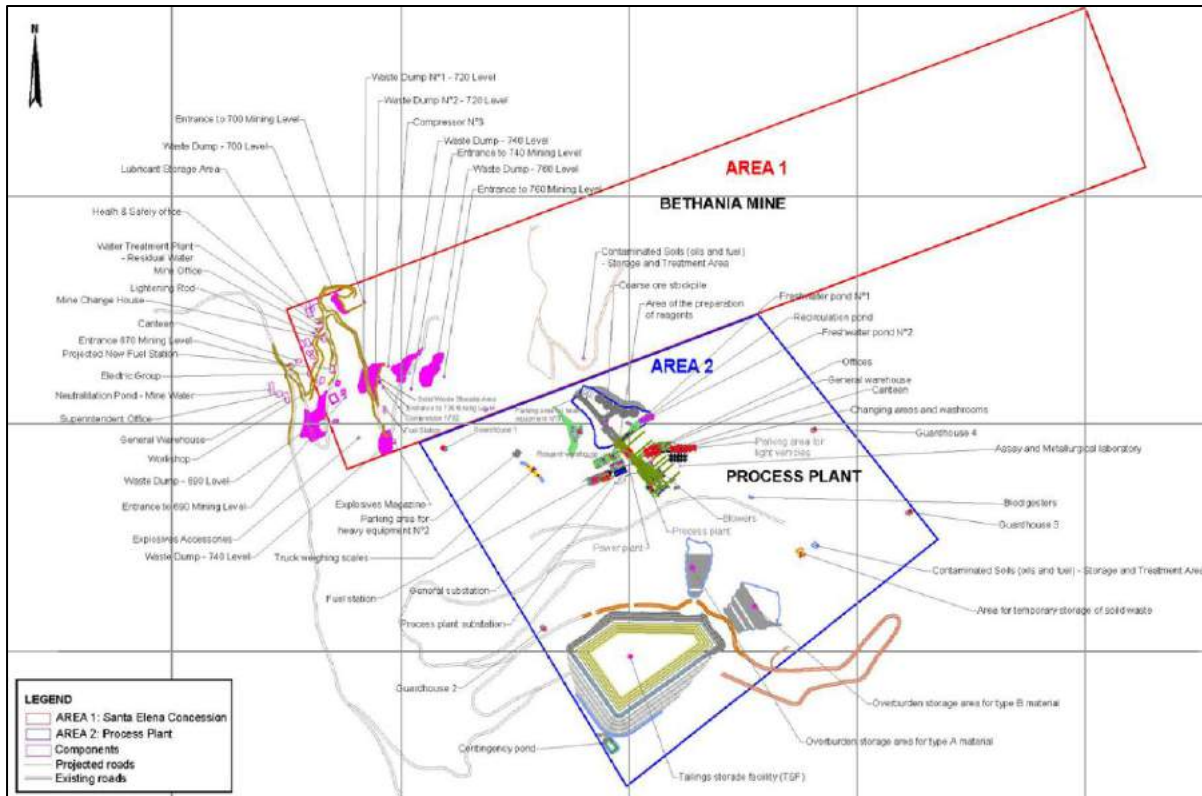

Figure 20-1: Identification of Area 1 and Area 2. Adapted from “NI 43-101 Technical Report & Mineral Resource Estimate” by Caracle Creek International Consulting Inc. February 21st, 2022.

As part of the process of evaluating and obtaining the environmental certification for Areas 1 and 2, Kuya provided the authorities with components, digital copies of the environmental studies whose objective was to support the obtaining of the project permits.

Finally, it is important to detail that the mine no longer qualifies as a Small Mining Producer (SMP) since May 5, 2021, which would imply that in the future it will be regulated under the General Mining Regime.

## 20.2 Historical Background

The earliest history of the Bethania mine comes from verbal communication with the local community, who claim that the silver veins in the region (eg, the Spanish Vein) were first mined by the Spanish in the 17th century, at through small-scale mining operations. Modern exploitation of the vein systems (Veta Española and Veta 12 de Mayo) began in 1977. Mining was suspended in the 1980s due to political problems in Peru (terrorism) and was subsequently restarted in 2008, continuing until the mid-1980s. 2016. The mineralized material was outsourced and processed at third party processing plants.



### 20.3 Environmental requirements and permits: overview of the legal framework

Economic activities in Peruvian territory, such as those related to the mining industry, are subject to a wide range of general environmental laws and regulations, among the most important:

- Political Constitution of Peru – Title III, Chapter II: Environment and Natural Resources.
- Law No. 25763, General Mining Law.
- DSN° 014-92-EM, Single Ordered Text of the General Mining Law.
- Law No. 28245 Framework Law of the National Environmental Management System.
- Law No. 28611, General Environmental Law.
- Law No. 27446, Law of the National Environmental Impact Assessment System.
- General Law on Solid Waste, enacted by Legislative Decree No. 1278 and its Regulations approved by Supreme Decree No. 014-2017-MINAM.
- DSN° 019-2009-MINAM - Regulation of the Law of the National Environmental Impact Assessment System, Law No. 27446.
- Supreme Decree No. 040-2014-EM: Regulations for environmental protection and management for mining exploitation, benefit, general work, transport and storage activities.
- Environmental quality standards (ECA's) for:
  - Water: DSN°004-2017-MINAM.
  - Air: DSN°003-2017-MINAM.
  - Noise: DSN°0085-2003-PCM.
  - Soils: DSN°011-2017-MINAM.

The environmental laws and regulations cited above govern the generation, storage, handling, use, disposal, and transportation of hazardous materials, the emission and discharge of hazardous materials into the soil, air or water. Likewise, they establish environmental quality standards for noise, water, air and soil, which are considered for the preparation, evaluation and approval of any environmental management instrument.

The main Regulatory Bodies that enforce general environmental laws and regulations are listed below:

- Ministry of Energy and Mines (MINEM) and the General Directorate of Mining (DGAAM).
- Ministry of the Environment (MINAM).
- National Environmental Certification Service for Sustainable Investments (SENACE).
- National Water Authority (ANA).

- General Directorate of Environmental Health (DIGESA).
- Ministry of Culture (MINCULT).
- Agency for Environmental Assessment and Enforcement (OEFA).

## 20.4 Environmental studies and permits

### 20.4.1 Area 1

#### 20.4.1.1 Environmental studies- Area 1

As detailed above, Area 1 has the DIA and its modifications, environmental documents that have been structured based on the following stages:

- Compilation and review of bibliographic and cartographic information.
- Characterization of the environment of the study area and description of the Project.
- Determination of potential environmental impacts.
- Preparation of plans and programs.
- Participatory information and consultation meetings.

The environmental management instrument detailed above has been developed in accordance with the provisions of general and specific regulations referring to the mining sector, health protection, regional and municipal environmental regulations, regulations related to environmental quality, regulations on biodiversity, what refers to the preservation of cultural heritage, among others.

The area of the Santa Elena concession (Area 1) is politically located in the district of Acobambilla, province and region of Huancavelica, on the surface land of the Poroche Farming Community, which is registered in the District of Colonia, province of Yauyos and Lima region.

The environmental conditions of Area 1 are described in detail from the ADIA, 2017.

*Table 20-1: Environmental conditions, physical appearance*

Environmental component	Detail
Topography	Topographically, the study area varies between 4,500 masl and 5,200 masl.
Physiography	At a regional level, the Project area is found in three (03) large groups: high Andean mountains with hilly reliefs and mountains, high Andean mountains with undulating plains and glaciers (snow-capped mountains). At the local level, the physiographic analysis delimited units subdivided into three groups: large landscape, landscape and sub-landscape.
Geomorphology	The area has been affected by intense glacial erosion. The following morphological units have been differentiated: plateau, steep to moderately steep slopes, moderate to strongly sloped slopes and depressions, glacial valley bottoms, glacial cirques and high hills.
Geology	Regionally, in the area of the Santa Elena concession, a volcanic dome developed, and this in turn is part of a volcanic caldera in the shape of an ellipse, whose limits are, on

Environmental component	Detail
	the north side, the Corihuarmi mine, on the east side the fault Chonta or Heraldos Negros Fault, on the south side with the Millococha mine and on the west side with the fault that separates the volcanic lithology from the caldera with upper Cretaceous sedimentary rock formations that correspond to the Jumasha formation limestone.
Floors	The soil is a natural, interdependent, three-dimensional and dynamic body, which occupies a space on the surface of the earth's crust. It is the product of the interaction of the different formation factors, such as parent material, climate, topography, organisms and time.
Climate and weather	According to the SENAMHI classification, this zone corresponds to classification B(I) D'H3 (rainy with dry, semi-frigid and humid winter). According to the Holdridge classification, the study area is located in the life zone called Tropical Alpine pluvial tundra (tp – AT). It is located in a cold climate zone. The season of greatest humidity coincides with the occurrence of rain events, reaching a monthly average maximum of 82% between the months of February and April. The average total annual precipitation is 729 mm/year, recorded in 41 years, varying between 205 mm in the driest year and 1,237 mm in the wettest year. Total annual evaporation is estimated at 1500 mm/year.
Air	The evaluation of air quality was carried out in the Project area in September 2015, these results have been used for the baseline of a study; since the ADIA has not registered significant changes in the Project area that alter the conditions of particle lifting in the area.
Hydrology	The Project is located within the micro-basin of the Antacocha River, an effluent of the Anta River, which flows into the Santa River and this in turn flows into the Vilca River, forming the Vilca-Santo River sub-basin, which flows into the Mantaro river.
Superficial water	There are intermittent streams without official designation, and adjacent to these are the Esperanza, Condoray, Capillayoc, Royal, Acchicocha and Angascocha lagoons. The Condoray, Acchicocha, Royal and Esperanza lagoons constitute the dominant feature within the Antacocha river basin near the Project. To assess the quality of the water, sampling was carried out in accordance with the water quality monitoring protocol for the MINEM mining subsector. The parameters for the evaluation of water quality are those established by the Ministry of Energy and Mines in RM No. 011-96-EM/VMM.
Underground water	The presence of numerous lagoons and wetlands in the region to which Area 1 belongs indicates the existence of groundwater near the surface, and a close association between surface and groundwater. No permanent water spring has been located in the exploitation areas.

Source: ADIA,2017

Table 20-2: Environmental conditions – biological aspect

Component environmental	Detail
Life zones	Three (03) Life Zones were identified within the Project area and its nearby area of influence: Pluvial Tundra – Tropical Alpine (tp – AT), Very Humid Paramo – Tropical Subalpine (pmh – SaT) and Level – Subtropical (NT).
Plant formations	Four (04) more specific plant formations were determined: scrub, rocky, grassland and bofedal.
Flora and vegetation	A total of 16 plant species, distributed in 13 genera and 6 families, were identified. Herbaceous plants are dominant in these environments, this type of vegetation has a series of morphological characteristics that are obviously related to climatic and physiographic characteristics. In the study area, species of wild flora used by the nearby population for medicinal purposes (M), use as firewood (L) and fodder (F) are reported. When comparing the list of registered species with the official list of species protected by Peruvian legislation through the DSN ° 043-2006-AG, a species of flora protected by

Component environmental	Detail
	our national legislation is reported; the “Huamapinta” Chuquiraga spinosa, categorized as a Near Threatened (NT) species. In addition,
Fauna	<p><u>Ornithofauna</u>: In the Project area, fifteen (15) species of birds grouped into thirteen (13) genera and ten (10) families were identified.</p> <p><u>mastofauna</u>: Three (03) species of mammals belonging to the families Chinchillidae, Cricetidae and Mephitidae are reported.</p> <p><u>Herpetofauna</u>: The evaluation of the herpetofauna was carried out using the Visual Encounter Survey (VES) technique, no species of amphibians and reptiles were recorded in the evaluation area.</p> <p>When comparing the list of registered species with the official list of species protected by Peruvian legislation through DSN° 034-2004-AG, no species protected by this standard are reported. Likewise, no species protected by international CITES regulations has been registered. The “Zorrillo” Conepatus chinga and the “Vizcacha” Lagidium peruanum are considered by the IUCN as low risk species (LR/LC).</p>
Hydrobiology	In the lagoons adjacent to the Santa Elena project, seven (07) species of benthic macroinvertebrates are recorded, grouped into four (04) phyllums. These insects are mostly larvae of aquatic life that are used as bioindicators of water quality. Likewise, this benthic fauna plays an important role in the food chains of aquatic environments, serving as food for fish and crustaceans, participating in the energy flow within the nutrient cycle.

Source: ADIA, 2017.

#### 20.4.1.2 Permits relative to the mine and associated infrastructure - Area 1

The mining titleholder has all the relevant permits required for current mining and metallurgical operations. These permits include operating licenses, mining concessions, water use licenses, environmental management instruments, among others, see Table 20-3.

The different permits, authorizations and licenses that the Santa Elena Concession-Area 1 has are summarized below.

Table 20-3: Existing environmental and social permits in Area 1 (Concessions Santa Elena)

Permit Type	Description	Approval Authority	Document of approval	Period	Date of emission
<b>Environmental permits and social agreements</b>					
DIA - Environmental Impact Statement	Approval of the extractive process for the Santa Elena Mining Project (Referred to as DIA of the "Santa Elena" Exploration and Exploitation Project in this report)	DREM - Huancavelica	Regional Directorial Resolution No. 102-2009-DIA	Undefined	November 32009
	Modification or Update of the DIA (2009). The objective of updating the DIA was to determine, evaluate and mitigate the environmental impacts of mining activities and update the environmental commitments of the company. Obligations: Execution of environmental monitoring, presentation of the annual declaration of solid waste and Annual Solid Waste Management Plan. Compliance with social commitments and those established in the Mine Closure Plan (Term 1 year).	DREM - Huancavelica	Regional Directorate Resolution No. 103-2017/GOB-REG-HVCA/GRDE-DREM	Environmental certification loses validity if within a maximum period of 3 years after its issuance the owner does not start works for the execution of the project, it can be extended up to 2 years	July 31st 2017

Permit Type	Description	Approval Authority	Document of approval	Period	Date of emission
	Modification or Update of the DIA (2017). The objective of updating the DIA is to determine, evaluate and mitigate the environmental impacts of the mining activities, as well as how the company intends to manage, prevent, mitigate, control and monitor the mining operation. The new component additions include the addition of a wastewater treatment plant (WWTP) and a volatilization field. Also, the update of coordinates of the components from PSAD 56 to WGS 84	DREM - Huancavelica	In evaluation	In evaluation	In evaluation
	Supporting technical report (ITS) of the Environmental Impact Statement (DIA-2009) and update of (DIA -2017) with which the mining exploitation project "Mina Santa Elena" has, its objective is to determine the reserves through the implementation of 20 diamond drilling platforms with a total of 54 drills. , qualification of 40 sedimentation ponds, assembly of auxiliary facilities for logging activities and projected accesses.	DREM - Huancavelica	Regional Directorate Resolution No. 005-2021/GOB-REG-HVAC/GRDE-DREM	9 months	February 16, 2021
Mine Closure Plan – mining exploitation project "	In accordance with the provisions of Supreme Decree 013-2002-EM, it is required to the small mining producer the presentation for the temporary or definitive closure of its work a Closure Plan that will include the measures to be adopted to avoid adverse effects on the environment due to the effects of solid, liquid or gaseous waste that may emerge in the short, medium or long term. The Mine Closure Plan is presented within a maximum period of one year after the DIA is approved.	DREM - Huancavelica	Regional Directorate Resolution No. 107-2018/GOB-REG-HVCA/GRDE-DREM	Undefined	December 5, 2018
Permits related to the use of water for exploitation mining	The ALA of Huancavelica, a subsidiary of ANA (National Water Authority) approved the license to use water for mining purposes. With this license, the Santa Elena mine is authorized to use 0.10 l/s of water from the Siete Gallos stream.	ALA - Huancavelica	Regional administrative resolutionNo. 056-2012-ANA-ALA-HUANCAVELICA	Undefined	April 112012
Certificate of non-existence of archaeological remains (CIRA)	The Huancavelica Decentralized Office of Culture issued a CIRA (Certification of Non-existence of Archaeological Remains) indicating that no archaeological remains were found within the undisturbed area of influence of the Santa Elena mining concession, which was previously approved by Directorial Resolution.	Decentralized Office of Culture of Huancavelica DDCHUV/MC	CIRA No. 004/DRC-HVCA-2010	Undefined	November 2, 2010
	The DDCHUV / MC (Decentralized Directora de Cultura Huancavelica / Ministry of Culture) issued a CIRA (Certification of non-existence of archaeological remains) indicating that no archaeological remains were found within the new undisturbed area of influence identified in the ITS modification of the DIA (2009) which was also modified for components in 2017.	Decentralized Office of Culture of Huancavelica DDCHUV/MC	CIRA No. 055-2021-DDCHUV/MC	Undefined	March 3 of2021
Archaeological Monitoring Plan (PMA)	On May 4, 2021, Minera Toro de Plata requested the approval of an Archaeological Monitoring Plan ("PMA") by submitting file No. 2021-0036855 to the Decentralized Office of Culture of Huancavelica. The WFP with pre-existing infrastructure also monitors the process of removal of land for modifications approved in the ITS through Regional Directorate Resolution No. 005-2021 / GOB-REG-HVAC /GRDE-DREM which is a modification of the DIA (2009). On May 23, 2021, the DDCHUV/MC issued observations to the file that required further explanation. On June 18, 2021, Minera Toro de Plata presents the acquittal of the observations made. The document presented is currently in the evaluation process of DDCHUV/MC.	Decentralized Office of Culture of Huancavelica DDCHUV/MC	In process	In process	In process
Surface Property Agreements	Contract of Usufruct, Surface and Easement signed on the 23rd of July 2013 with the Farming Community of Poroche signed for a period of 6 years. On October 26, 2020, the fifth addendum to the aforementioned contract is signed, extending the term of the contract until August 31, 2022.	Farming Community of Poroche	Usufruct Contract, Surface and private easement	Until August 31, 2022	July 23, 2013

Permit Type	Description	Approval Authority	Document of approval	Period	Date of emission
Explosives magazine Permit (SUCAMEC)	On May 10 of the present it was published Legislative Decree No. 1500, which indicates the following: "Authorizations, permits, licenses and any other qualifying title that has temporary validity, as well as environmental certifications, that are necessary for the implementation of public, private or public investment projects in public infrastructure or public services, whose validity ends until December 31, 2020, remain in force for twelve (12) months after their expiration date", exclusive provision to reactivate, improve and optimize the execution of projects public, private and public-private investment. In this sense, the validity of the Toro de Plata permits was extended, and we are currently preparing the technical file for its next presentation to the authority.	SUCAMEC	In process	In process	In process
<b>Construction Permits and Operation</b>					
COM - Santa Elena Mine	The GRED-DREM (Regional Government of Huancavelica and Regional Directorate of Energy and Mines) approved the start of activities mining.	GRED-DREM - Huancavelica	Regional Directorate Resolution No. 040-2015/GOB-REG-HVCA/GRDE-DREM	3 years	July 3, 2015

Source: EIASd, 2019.



## 20.4.2 Area 2

### 20.4.2.1 Environmental Studies- Area 2

For the preparation of the EIA<sub>s</sub>d, 2019, Kuya submitted to the Huancavelica Regional Directorate of Energy and Mines (DREM-Huancavelica), the proposed terms of reference for the environmental classification of the "Bethania Plant" Beneficiation Concession project, the which was approved on January 31, 2019 through Regional Directorial Resolution No. 005-2019/GOB.REG.HVCA-DREM, where the environmental classification is granted in category II: Semi-detailed Environmental Impact Study (EIA<sub>s</sub>d) and the terms of reference (ToR) for the preparation of the Semi-Detailed Environmental Impact Study of the Bethania Plant Beneficiation Concession project. The structure of this EIA<sub>s</sub>d consists of eleven (11) chapters which are: Executive Summary, Background, Introduction, Citizen Participation Plan.

The chapters mentioned in the previous paragraph have been developed considering what is established in general and specific regulations referring to the mining sector, health protection, regional and municipal environmental regulations, regulations related to environmental quality, regulations on biodiversity, what refers to the preservation cultural heritage, among others.

The area where the Planta Bethania benefit concession is located (Area 2) is politically located in the district of Acobambilla, province and region of Huancavelica, on the surface land of the Poroche Farming Community, which is registered in the Colonia District, province of Yauyos and Region of Lima.

After reviewing the map of the National System of Protected Natural Areas, it was determined that the area of interest is far from protected natural areas (ANP), the minimum distance to the buffer zone of the closest national reserve called Reserva Paisajística Nor Yauyos Cochas is 22.22 km, it is also 115.80 km from the National Reserve System of Guaneras Islands, Islets and Points - Asia Island.

According to what is specified in the EIA<sub>s</sub>d, 2019, the project has an Environmental Influence Area (AIA), which was determined based on the qualitative and quantitative identification of the possible potential, slight, moderate or positive environmental impacts due to execution of project activities. It is important to specify that this (AIA) has been approved by obtaining the environmental certification of the EIA<sub>s</sub>d, 2019.

The environmental conditions of the area of interest in Area 2 are described in detail.

Table 20-4: Environmental conditions, physical appearance

Environmental component	Detail
Topography	It is located above the altitude elevation of 4,650 meters above sea level, dominated by mountain-type elevations that are sometimes over 4,850 meters above sea level, which corresponds to the Andean region of central Peru in the department of Huancavelica. It is important to specify that the operating area is in a flat area in its greatest extension.
Physiography	It presents a dominant mountainous physiography that includes undulating surfaces and eventually small wetlands known as bofedales, distributed within a hydrographic system of the dendritic type, coming from the highlands.
Geomorphology	It presents different forms of the terrestrial relief and the processes that generate it (geographical, biotic, geological and anthropic). The geoforms were identified: puna and slopes or slopes.
Geology	Regionally, in the area of the Santa Elena concession, a volcanic dome developed, and this in turn is part of a volcanic caldera in the shape of an ellipse, whose limits are, on the north side, the Corihuarmi mine, on the east side the fault Chonta or Heraldos Negros Fault, on the south side with the Millococha mine and on the west side with the fault that separates the volcanic lithology from the caldera with upper Cretaceous sedimentary rock formations that correspond to the Jumasha formation limestone. Rocks from the Cenozoic era belonging to the Quaternary system outcrop in the area. The stratigraphy of the area of indirect environmental influence of the project is mainly represented by fluvio-glacial deposits, in the area there are subvolcanic rocks (andesite), as well as volcanic morphostructures (undifferentiated tuffs and Andesitic lavas). Locally, there are lithostratigraphic units from the Cenozoic era of the Quaternary system belonging to the Holocene and Miocene series. Nine (09) lithostratigraphic units were found in this area, among them we have: biogenic deposit (bofedal), colluvial deposit, colluvial deposit, proluvial deposit 1, proluvial deposit 2, deluvial deposit, alluvial deposit, upper Auquivilca formation, middle Auquivilca formation and Lower Auquivilca.
Floors	Soil types belonging to the order Histosols, Entisols and Inceptisols were identified in the area of interest. With respect to the greater use capacity of the soils, two (02) groups of greater use have been identified and these are: land for pasture (P) and land for protection (X). Finally, with respect to the current use of the land, 90.20% corresponds to bare land, that is, coverage without vegetation.
Climate and weather	The project area is approximately 4,670 meters above sea level with an average monthly temperature that ranges between 2.98 °C and 5.78 °C, the coldest month being July while the warmest month is December. It presents a high relative humidity between the months of February to April while the minimum occurs in the months of November. Likewise, the minimum values of precipitation are between the months of June to August and the maximum values start from the month of December and end in March, for which it is described as a rainy area in the summer season.
Air	Air quality monitoring was carried out on June 12 and 13, 2019 for sampling points AIR-01 (windward) and AIR-02 (leeward). The evaluation was carried out in accordance with the criteria recommended by the Environmental Guide for air quality of the MEM, in order to establish the initial conditions in the area. Four (04) parameters were analyzed at each sampling station: PM10, SO <sub>2</sub> , NO <sub>2</sub> and CO. The results at each sampling station were compared with the values established in the Environmental Quality Standard for air (ECA-air) approved by DSN°003-2017-MINAM, showing that the concentrations of PM10, SO <sub>2</sub> , NO <sub>2</sub> and CO existing in the project area are less than the values established in the ECA-air.
Noise	Air quality monitoring was carried out on June 12 and 13, 2019 for sampling points RU-01 (windward) and RU-02 (leeward). The evaluation was developed according to the ISO-Technical Standards in order to establish the initial conditions in the area. The results at each sampling station were compared with the values established in the Environmental Quality Standard for noise (ECA-noise) approved by DSN°085-2003-PCM, showing that the existing noise levels in the project area are lower. than the values established in the ECA-noise for industrial zone.
Surface water quality	Surface water quality monitoring was carried out on June 13, 2019 in the Thanua stream at sampling points AG-01 and AG-02 and AG-03. The results obtained from these parameters were compared with the values established in category 3, subcategory D1:Irrigation of vegetables and D2:Drinking of animals of the National Standards of Environmental Quality for Water (ECA-water) approved according to DS N° 004- 2017-MINAM, it is concluded that said current environmental regulations are complied with because the results are below the levels established in the ECA-water.
Soil quality	Soil quality monitoring was carried out on June 13, 2019 at monitoring point SUE-01. The parameters evaluated were: free cyanide, total petroleum hydrocarbons fraction 1, total petroleum hydrocarbons fraction 2, total petroleum hydrocarbons fraction 3, the metals analyzed were arsenic, barium, cadmium, chromium, hexavalent chromium, mercury and lead. The results were compared with the values established in the National Environmental Quality Standard for soils (ECA-soil) approved according to Supreme Decree No. 011-2017-MINAM. The results of the parameters analyzed are below the levels established in the ECA-soil, with which it is concluded that the current environmental regulations are complied with.

Source: EIAAsd, 2019.

Table 20-5: Environmental conditions, biological aspects

Environmental component	Detail
Life zones	According to the classification of life zones by Dr. Leslie Holdridge, framed in the three latitudinal regions that cover the country and to the Explanatory Guide: Ecological Map of Peru, published by INRENA in 1995, the area of interest includes the life zones: Subtropical Pluvial-Alpine Tundra (tp-AT) and Tropical Nival (NT).
Plant formations	Three (03) plant formations were recorded according to the National Map of Plant Cover (2015) of MINAM, being the following: Pajonal Andino (Pj), Area of scarce vegetation and without vegetation (Esv) and Bofedal (Bo)
Flora and vegetation	For the evaluation of the wild flora, seven (07) sampling stations were established considering the distribution of the cover and the vegetal formations within the study area. To evaluate the flora, the linear transect or intersection line (Canfield method) was used as a sampling method, which consists of making observations on lines extended through the vegetation. Linear transects of 25 meters with a width of two (02) meters on each side of the line were used for the evaluation. Seven hundred fifty-four (754) individuals distributed in thirteen (13) families, thirteen (13) species and five (05) orders were recorded. No endemic species or any species in any conservation category were recorded
Fauna	<p><u>Ornithofauna:</u> For the evaluation of the ornithofauna, six (06) sampling stations were established considering the distribution of coverage and plant formations within the study area. The main methodology used was point counting (Bibby et al 1993), the counting points were located at 100 m. Along a 500 m transect, the permanence time per point was a minimum of 15 minutes. Eighty-three (83) individuals distributed in seven (07) families, thirteen (13) species and three (03) orders were recorded. No endemic species were recorded, however, according to the red book (IUCN, 2019-II) five (05) species were reported within the category of least concern (LC).</p> <p><u>mastofauna:</u> For the evaluation of the mastofauna, twelve (12) sampling stations were established: six (06) for smaller mammals and six (06) for larger mammals. For the evaluation of smaller mammals, 20 live capture traps of ten Sherman type and ten Tomahawk type were used for live capture, a transect was established per sampling station, while for the registration of larger mammals the transect was used. of variable width or linear transect (Ministry of the Environment, 2015) which consists of leisurely walks of 500 m. per transect which were traversed twice to obtain a length with a total length of 1 km. and with a total time of 1.5 hours. Fifteen (15) individuals distributed in three (03) families; three (03) orders were registered. In addition, three (03) species of domestic mammals were recorded. No endemic species were recorded, however, according to the red book (IUCN, 2019-II) three (03) species were reported within the category of least concern (LC).</p> <p><u>Herpetofauna:</u> For the evaluation of the herpetofauna, seven (07) sampling stations were established considering the distribution of cover and plant formations within the study area. The methodology used was the evaluation by visual record or Visual Encounter Survey (VES) (Crump and Scott, 1994). When evaluating the sampling stations, no species of reptiles or amphibians were recorded.</p>
Hydrobiology	The hydrobiological evaluation was carried out in the Thanua creek (AG-01) and the Bethania creek (AG-02). The methodology used was that proposed in the guide “Methods of collection, identification, and analysis of biological communities: plankton, periphyton, benthos (macrovertebrates) and nekton (fish) in continental waters of Peru” - 2014. For phytoplankton, one hundred two (102) individuals distributed in ten (10) species and ten (10) families. Regarding zooplankton, sixty-one (61) individuals distributed in seven (07) species and five (05) families were recorded. On the other hand, for the periphyton, three hundred thirty-one (131) individuals distributed in six (06) species and six (06) families were registered. Finally, regarding Nekton, no species was recorded during the hydrobiological monitoring.

#### 20.4.2.2 Permits related to the process plant, TSF and associated infrastructure- Area 2

The mining titleholder has all the relevant permits required for current mining and metallurgical operations. These permits include operating licenses, mining concessions, water use licenses, environmental management instruments, among others, see Table 20-6.

The various permits, authorizations and licenses that Area 2 has are summarized below.

Table 20-6: Existing environmental and social permits in the Area 2 (Benefit Concession – “Bethania Plant”)

Permit Type	Description	Approval Authority	Document of approval	Period	Date of emission
<b>Environmental permits and social agreements</b>					
EIAsd - Semi detailed Environmental Impact Study	Approval of the terms of reference necessary for the development of the EIAsd "Bethania Plant"	DREM - Huancavelica	Regional Directorate Resolution No. 005-2019/GOB-REG-HVCA/GRDE-DREM	Undefined	January 31, 2019
	Tailings Facility Approval of the Beneficiation plant and associated infrastructure that includes chemical and metallurgical testing laboratory, offices, dining room, powerhouse, parking areas for heavy and light vehicles, changing rooms and bathrooms, security controls, general store, storage areas for reagents and solid waste material, for reagent preparation, electrical and mechanical workshops, general substation and substation for process plant, blowers, fuel storage and distribution area, water tanks, recirculated water and overflow contingency, designated storage for type A and B material areas, thick storage of ROM and volatilization field.	DREM - Huancavelica	Director Resolution No. 032-0200/GOB.REG.HVCA/GRDE/DREM	Undefined	August 21, 2020
Plan for the Closure of the Beneficiation Plant "Bethania Plant"	In accordance with the provisions of Supreme Decree 033-2005-EM, Kuya is required that is in operation or developing the start of new mining operations, the presentation of a mine closure plan that groups technical and legal actions to rehabilitate the areas disturbed by mining activity at the feasibility level. In the case of Toro de Plata, preliminary meetings have already begun with the consultant for the purpose of presenting the plan to the authority.	DREM - Huancavelica	In process	In process	In process
Permits related to the use of water for the Plant of benefit "Bethania Plant"	There is a water use agreement with the community by Bethania	Community	To define	To define	To define
Certificate of non-existence of archaeological remains (CIRA)	The DDCHUV / MC (Decentralized Directorate Culture Huancavelica / Ministry of Culture) issued a CIRA (Certification of Non-existence of Archaeological Remains) indicating that no archaeological remains were found within the undisturbed area of the Bethania Plant Project. That includes the components established in the EIAsd such as the plant, tailings deposit and associated infrastructure previously approved by Directorial Resolution No. 032-0200 / GOB.REG.HVCA / GRDE / DREM.	DDCHUV/MC - Huancavelica	CIRA No. 155-2020-DDCHUV/MC	Undefined	December 7, 2020
Archaeological Monitoring Plan (PMA)	The DDCHUV / MC (Decentralized Directorate of Huancavelica Culture / Ministry of Culture) is evaluating File No. 67709-2021 through which the authority will issue the corresponding certification of the absence of archaeological remains on the disturbed areas of the Project that are not included within the approved CIRA.	DDCHUV/MC - Huancavelica	In evaluation	Undefined	28 of July from 2021
Benefit Concession Bethania Plant (Construction License and Operating Authorization)	The generation of the concession of benefit and authorization to start the construction of the concentrator plant. On December 14, 2020, Minera Toro de Plata submitted File No. 373 to the Ministry of Energy and Mines (MEM) requesting the granting of the benefit concession and authorization to start the construction activities of the process plant, deposit of tailings and associated infrastructure (Plant Bethania). Minera Toro de Plata is awaiting a response from the MEM.	DREM - Huancavelica	Awarded	Undefined	January 24, 2022.

Permit Type	Description	Approval Authority	Document of approval	Period	Date of emission
Surface Property Agreements	Contract of Usufruct Surface and Easement elevated to Public Deed dated November 6, 2013 by the Rural Community of Poroche through which the community grants Minera Toro de Plata the right of usufruct over the surface land on which the Plant will be developed, being able to use and enjoy it for 6 years that concluded on October 18, 2019. On August 21, 2019, the Addendum to the Usufruct Contract was signed with the Rural Community of Poroche in order to modify the area granted in usufruct and clarify its coordinates. Likewise, the powers over the right of usufruct are extended and the term of validity is modified to perpetuity.	Farming Community of Poroche	Public Deed granted before Notary Public Marcial Ojeda Sanchez	Perpetual	November 6, 2013 and August 21, 2019
Beneficiation Concession Title and Construction Permit for the Beneficiation Plant	Grant the concession title for the Bethania Plant with code No. P090000220 comprised of 36,3969 ha., as well as authorize the construction of the plant of the same name with a capacity of 350 MT/day.	DREM - Huancavelica	Regional RD No. 092-2021/GOB.REG-HVCA/GRDE-DREM	Undefined	December 22, 2022.

Source: Kuya, 2021

### 20.4.3 Environmental impacts

Based on the IGAs approved in Areas 1 (ADIA, 2017) and Area 2 (EIAsd, 2019), the existing environmental impacts have been identified. The environmental impact assessment has been developed including current Peruvian environmental regulations, related to environmental quality standards and the protection of flora and fauna species. In cases where there were no specific standards, reference indicators used by national and international institutions linked to environmental conservation were used, see Table 20-7.

In summary, the methodological procedure followed to carry out the identification and evaluation of the environmental impacts in the previous IGAs was carried out as follows:

- Analysis of activities.
- Analysis of the environmental situation of the environment in which the components will be located.
- Identification of potential environmental aspects and impacts.
- Description of the main potential environmental impacts.

It is important to detail that these identified potential impacts have environmental management measures declared to date and that are still in force.

With regard to social impacts, within the approved Management Plan, the approach to local authorities and the general population of the district level has been considered. Likewise, the owner seeks to promote social programs that facilitate the labor reinsertion of workers through programs of labor reconversion, training (development of technical and business capacities).



Table 20-7: Significance and nature of social and environmental impacts identified in previous IGAs

Environmental Component	Potential Impact	Area 1 -ADIA, 2017		Area 2- EIAsd, 2019		
		Operation	Closing	Building	Operation	Closing
Air Quality	Altered air quality due to dust	Under (-)	Low (+)	Under (-)	Under (-)	Under (-)
	Alteration of air quality by gases	UI	UI	Under (-)	Under (-)	Under (-)
Ambient noise	Increased ambient noise	Under (-)	Low (+)	Under (-)	Under (-)	Under (-)
Topography and Relief	Modification of the local relief	Moderate (-)	UI	Under (-)	Moderate (-)	UI
	Restoration of soil stability	UI	Low (+)	UI	UI	Low (+)
Water	Reduced availability of water	UI	UI	Under (-)	Under (-)	UI
	Alteration of water quality	Under (-)	Low (+)	UI	UI	UI
	Alteration of groundwater quality	Under (-)	Low (+)	UI	UI	UI
Ground	Alteration of soil structure	UI	UI	Under (-)	Under (-)	UI
	Alteration to soil quality	Under (-)	Low (+)	UI	UI	UI
Current Land Use	Land-use change	UI	UI	Under (-)	UI	UI
	Land use recovery	UI	UI	UI	UI	Moderate (+)
Landscape	Affectation of the local landscape	Under (-)	UI	Under (-)	Moderate (-)	UI
	Recovery of the local landscape	UI	Low (+)	UI	UI	Low (+)
Wild flora	Loss of vegetation cover	Under (-)	UI	Under (-)	UI	UI
	Flora habitat loss	UI	UI	Under (-)	Under (-)	UI
	Recovery of flora habitat	UI	Low (+)	UI	UI	23
Wildlife	Alteration of fauna habitat	Under (-)	UI	Under (-)	Under (-)	Under (-)
	Recovery of wildlife habitat	UI	Low (+)	UI	UI	Low (+)
	Affectation of the health of workers	Under (-)	UI	Under (-)	Under (-)	UI
Economy	Employment generation	Low (+)	Low (+)	Low (+)	Low (+)	Low (+)
	Increased local economic flow	Low (+)	Under (-)	Low (+)	Low (+)	Low (+)
Human Interest	Generation of annoyances or conflicts	UI	UI	Under (-)	Under (-)	Under (-)

UI: Unidentified impact. In the ADIA, 2017, no impacts were identified in the construction stage.

As part of the monitoring of the environmental measures proposed in the various IGAs approved for Area 1 and Area 2, for the mitigation of the potential environmental impacts identified, the implementation of an Environmental Monitoring Plan (EMP) has been proposed.

In accordance with what was approved in the ADIA; 2017 (Area 1) Kuya has an EMP through which the monitoring of the quality of the different environmental factors is carried out, as well as control systems and proposed measures for the mitigation of the potential impacts identified in the previous IGAs.

The PMA will allow to identify the fulfillment of the indications and measures; preventive and corrective measures in order to achieve the conservation and sustainable use of natural resources and the environment during the operation.

There are the following proposed environmental monitoring:

Air quality monitoring:

- Monitoring stations: i) EB-1 (windward of operations: N: 8,602,830 and E: 442,597) and ii) EB-2 (leeward of operations: N: 8,602,970 and E: 442,215).
- Parameters: Particles in suspension (PM10), lead content (Pb); arsenic (As) content; sulfur dioxide content (SO<sub>2</sub>); nitrogen dioxide (NO<sub>2</sub>) content; carbon monoxide (CO) content; hydrogen sulfide (H<sub>2</sub>S) content; ozone content (O<sub>3</sub>); meteorological parameters (environmental temperature, relative humidity, wind speed, wind direction).
- Frequency: The frequency of air quality monitoring will be annual, with the presentation of an annual report, the same that will be compared with the Limit Values established in the National Standards of Environmental Air Quality (DSN° 074-2001-PCM and DSN 003-2008-MINAM) as well as the values established as Maximum Permissible Levels of Elements and Compounds Present in Gaseous Emissions from Metallurgical Mining Units, proposed by RMN° 315-96 EM/VMM.

Environmental noise monitoring:

- Monitoring stations: i) RU-01 (Populated center, near the chapel: N: 8 602 988 and E: 442 219) and ii) RU-02 (administrative offices: N: 8 602 917 and E: 442 393).
- Parameters: sound pressure level L<sub>Max</sub> (day and night); sound pressure level L<sub>Min</sub> (day and night) and sound pressure level L<sub>Aeqt</sub> (day and night).
- Frequency: The environmental noise monitoring frequency will be annual, with the presentation of an annual report, the same that will be compared with the Regulation of National Environmental Quality Standards for Noise (DSN°085-2003-PCM).

Water quality monitoring:

- Monitoring stations: i) EM-1 (Effluent from all levels in the mouth of NV-670: N: 8,602,858 and E: 443,349).
- Parameters: pH, total suspended solids; oils and fats; total cyanide, total arsenic; total cadmium; hexavalent chromium; total copper; total iron; Fe+2; total lead; total mercury; total zinc and total manganese.
- Frequency: The frequency of water quality monitoring will be annual, with the presentation of an annual report, which will be compared with the Maximum Permissible Limits for the discharge of liquid effluents from mining and metallurgical activities (DSN° 010-2010- MINAM). and the Water Quality Standards (DSN° 002-2008-MINAM) for Category 3, Parameters for watering vegetables and drinking animals.

Air quality monitoring:

- Monitoring stations: i) EB-1 (barlovento de las operaciones: N: 8 602 830 y E: 442 597) y ii) EB-2 (sotavento de las operaciones: N: 8 602 970 y E: 442 215).
- Parameters: Suspended particles (PM10), lead content (Pb); arsenic content (As); sulfur dioxide content (SO2); nitrogen dioxide content (NO2); carbon monoxide content (CO); hydrogen sulfide content (H2S); ozone content(O3); meteorological parameters (temperature, relative humidity, wind speed, wind direction).
- Frequency: The frequency of air quality monitoring will be annual, with the presentation of an annual report, which will be compared with the limit values established in the National Standards of Environmental Air Quality (D.S. N.° 074-2001-PCM y D.S. N.° 003-2008-MINAM) as well as the values established as Maximun Permissible Levels of elements and compounds present in gaseous emissions from the metallurgical mining units, proposed by R.M. N.° 315-96 EM/VMM.

## 20.5 Environmental liabilities

According to what is detailed in the ADIA, 2017 environmental liabilities, product of previous mining activities carried out by previous owners, have been classified according to their characteristics, in the following categories:

- Abandoned works: pits, mine entrances and drives, chimneys.
- Abandoned buildings and facilities: waste dumps, mineralized material fields.
- Disturbed areas: accesses to mine entrances and old workings.

In said environmental document, the companies (previous owners) that left the liabilities were identified: S&L Andes Export SA and SANSIL SRL.

It is important to emphasize that the remediation of the identified areas has been included in the mine closure plan approved by Regional RD No. 107-2018/GOB-REG-HVCA/GRDE-DREM.

According to the information provided by Kuya, it is detailed that there are no registered environmental liabilities within the Santa Elena concession (Area 1) or in the Bethania benefit concession (Area 2). Several environmental liabilities were recorded to the south and west of both areas, however, the person responsible was listed as unknown. Most of the environmental liabilities are within other Kuya concessions; however, according to Peruvian law, Kuya is not responsible for the remediation of these liabilities, since they were generated by unknown third parties, see Figure 20-2.

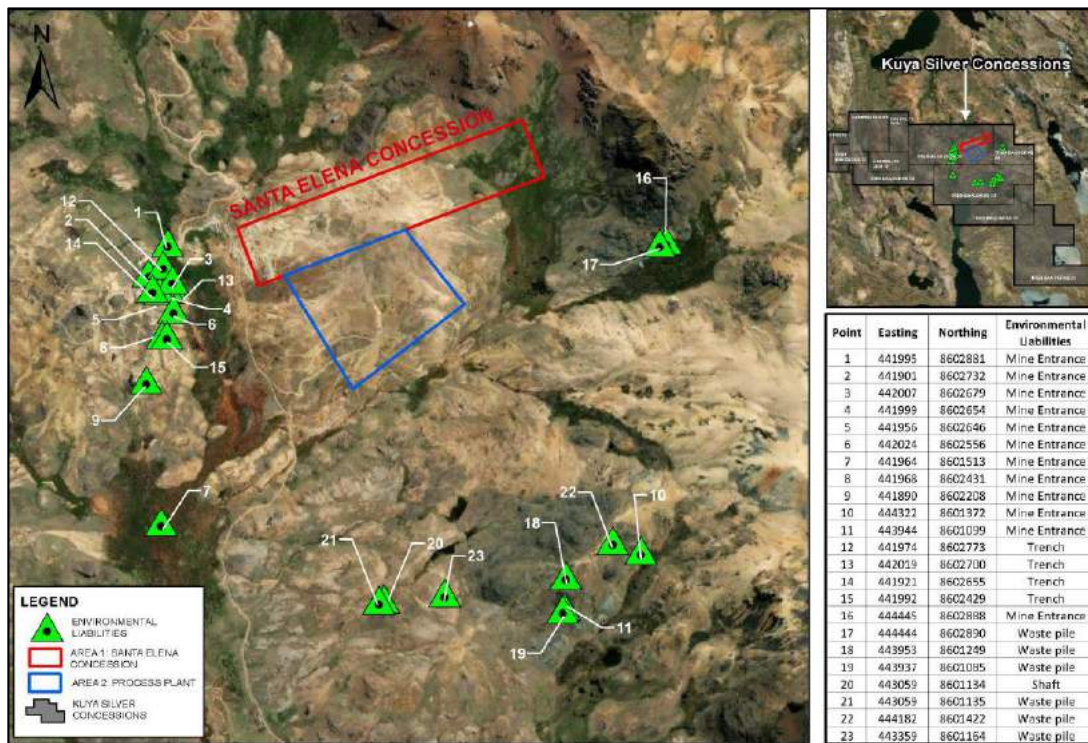

Figure 20-2: Existing environmental liabilities (Source: Kuya). Adapted from “NI 43-101 Technical Report & Mineral Resource Estimate” by Caracle Creek International Consulting Inc. February 21st, 2022.

## 20.6 Mine closure

### 20.6.1 Area 1

In accordance with the provisions of DSN°013-2002-EM, the small mining producer is required to present a Closure Plan for the temporary or permanent closure of its work, which will include the measures to be adopted to avoid adverse effects on the environment due to of solid, liquid or gaseous waste that may surface in the short, medium or long term.

The Mine Closure Plan is presented within a maximum period of one year from the approval of the environmental management instrument. That is why, through Regional RD No. 107-

2018/GOB-REG-HVCA/GRDE-DREM dated December 5, 2018, the Closure Plan for the Santa Elena Concession was approved.

Kuya is currently in the process of modifying the ADIA, 2017 to include new components (water treatment plant to treat wastewater and an area for the treatment of soil contaminated with hydrocarbons). The application was submitted on December 14, 2020 and is being processed.

### **20.6.2 Area 2**

The closure plan for the Bethania Beneficiation Concession (Area 2) was presented in November 2021.

Closure plans are based on Law No. 28090, Law that Regulates the Closure of Mines, its Regulations for the Closure of Mines, approved by DSN No. 033-2005-EM and its respective amendments. The regulation has as its objectives the prevention, minimization and control of risks and effects on the health, safety of people, the environment, the surrounding ecosystem and property, which could derive from the cessation of operations of a project.

#### **20.6.2.1 Objectives of the closure plan**

The main objective of the Closure Plan is to ensure that the environment where the mining activity takes place recovers the quality conditions necessary to ensure its sustainability, either in conditions similar to those it had before the start of operations, and/or conditions of alternative use that are environmentally viable and that at the same time are in accordance with the particular characteristics of the area.

- Objective in human health and safety - It is to guarantee the preservation of the health and safety of people through the design and construction of civil works, through physical, geochemical and hydrological stability works of the mining components, with the purpose that in the long term they do not generate negative impacts, nor physical risk conditions produced by natural events.
- Physical stability objectives - It is to apply the technical criteria to avoid any type of displacement or movement of the implemented activities, ensuring the stability of slopes, of the covers, as well as the design of the containment works and the restriction of access to the facilities, in order to avoid risks of slipping and movements to guarantee the safety of people, animals and property.
- Geochemical stability objectives - It is to prevent the occurrence of chemical reactions that are harmful to the environment in the different closed components, such as the generation of drainage (DAR) by isolating one of the components that favor the generation of ARD in the long term, with the purpose that the closure activities of the mining components allow the restored component to be integrated into the environment and does not generate conditions of negative environmental risk.



- Objectives of land use - Restore, as far as possible, the landscape aspect of the spaces disturbed by mining activities, in order to recover conditions similar to their natural state and the restored areas serve for some activity favorable to the populations in the environment.
- Objectives of the use of bodies of water - It is to present and rehabilitate the watercourses, through activities that reduce the negative impacts on the environment, by monitoring the quality of the waters and their evaluation over time, in order to that the impacts can be minimized, the area can be recovered to its natural state.
- Social objectives - Promote social programs that facilitate the labor reintegration of workers through programs of job retraining, capacitation (development of technical and business skills), extending to the communities in the area of direct and indirect influence, in order to maintain the development of the local economy and improve the quality of life of the community, upon closure of mining operations.

#### 20.6.2.2 Closing components

The closing components are as follows.

Table 20-8: Closure components approved in the EIAsd, 2019

No.	Components	Coordinates		Stage Closing
		WGS 84-UTM		
		East	North	
01A	Surveillance checkpoint 1	442613.41	8602705.07	Final
01B	Surveillance checkpoint 2	442788.65	8602389.44	Final
01C	Surveillance checkpoint 3	443430.22	8602594.70	Final
01D	Surveillance checkpoint 4	443263.68	8602740.16	Final
PB 02	Thick court	442899.82	8602753.36	Final
PB 03	Fresh water pool 1	442938.44	8602734.77	Final
PB 04	Fresh water pool 2	442941.69	8602737.11	Final
PB 05	Recirculated water pool	442945.40	8602742.23	Final
PB 06	Benefit plant	442944.66	8602685.24	Final
PB 07	Tailings deposit	442963.35	8602319.90	Final
PB 08	Collection of own material A	443049.54	8602496.95	Final
PB 09	Collection of own material B	443158.30	8602428.10	Final
PB 10	Contingency pool	442907.37	8602184.54	Final
PB 11	Metallurgical and chemical laboratory	443003.67	8602711.82	Final
PB 12	Offices	442955.54	8602731.12	Final
PB 13	Dining room	443037.66	8602693.12	Final
PB 14	Changing rooms and toilets	442942.29	8602658.84	Final
PB 15	Plant substation	442927.43	8602663.36	Final
PB 16	General substation	442919.68	8602658.25	Final
PB 17	Blowers	442970.88	8602682.46	Final



No.	Components	Coordinates WGS 84-UTM		Stage Closing
		East	North	
PB 18	House strength	442946.46	8602673.18	Final
PB 19	Mechanical and electrical maintenance workshop	442877.58	8602664.08	Final
PB 20	General storehouse	443038.03	8602712.43	Final
PB 21	Reagent store	442896.40	8602697.61	Final
PB 22	Reagent preparation	442910.47	8602700.71	Final
PB 23	Biodigesters	443153.81	8602620.95	Final
PB 24	Heavy vehicle parking	442989.00	8602758.92	Final
PB 25	Heavy vehicle parking	442889.01	8602562.16	Final
PB 26	Light vehicle parking	442974.63	8602703.73	Final
PB 27	Balance	442942.13	8602576.74	Final
PB 28	Fuel tank	442941.15	8602669.49	Final
PB 29	Solid waste deposit warehouse	443240.43	8602523.62	Final
PB 30	Volatilization field	443266.10	8602536.22	Final

### 20.6.2.3 Closing criteria

The table below shows the closing criteria for each component.

Table 20-9: Closure criteria proposed in the EIAs, 2019

No.	Components	Closing Activities					
		Dismantling, Demolition and salvage	Physical stability	Geochemical stability	Hydrological Stability	Establishment of the shape of the land	Revegetation
01A	Surveillance checkpoint 1	If it deserves	Refine and leveling	Does not require Geochemical stability	Does not require Hydrological Stability	If it deserves	Does not deserve
01B	Guardhouse 2	If it deserves	Refine and leveling	Does not require Stability Geochemistry	Does not require Stability Hydrological	If it deserves	Does not deserve
01C	Guardhouse 3	If it deserves	Refine and leveling	Does not require Stability Geochemistry	Does not require Stability Hydrological	If it deserves	Does not deserve
01D	Guardhouse 4	If it deserves	Refine and leveling	Does not require Stability Geochemistry	Does not require Stability Hydrological	If it deserves	Does not deserve
PB 02	Thick court	Does not deserve	Refine and leveling	Does not require Stability Geochemistry	If you need stability Hydrological	If it deserves	Does not deserve
PB 03	Fresh water pool 1	If it deserves	Refine and leveling	Does not require Stability Geochemistry	Does not require Stability Hydrological	If it deserves	Does not deserve
PB 04	Fresh water pool 2	If it deserves	Refine and leveling	Does not require Stability Geochemistry	Does not require Stability Hydrological	If it deserves	Does not deserve
PB 05	Recirculated water pool	If it deserves	Refine and leveling	Does not require Geochemical stability	Does not require Hydrological Stability	If it deserves	Does not deserve
PB 06	Benefit plant	If it deserves	Refine and leveling	Does not require Geochemical stability	Does not require Hydrological Stability	If it deserves	Does not deserve

No.	Components	Closing Activities					
		Dismantling, Demolition and salvage	Physical stability	Geochemical stability	Hydrological Stability	Establishment of the shape of the land	Revegetation
PB 07	Tailings deposit	Does not deserve	Refine and leveling	If you need stability  Geochemistry	If you need stability  Hydrological	If it deserves	If it requires
PB 08	Collection of own material A	Does not deserve	Refine and leveling	Does not require Stability  Geochemistry	If you need stability  Hydrological	If it deserves	Does not deserve
PB 09	Collection of own material B	Does not deserve	Refine and leveling	Does not require Stability  Geochemistry	If you need stability  Hydrological	If it deserves	Does not deserve
PB 10	Contingency pool	If it deserves	Refine and leveling	Does not require Stability  Geochemistry	Does not require Stability  Hydrological	If it deserves	Does not deserve
PB 11	Metallurgical and chemical laboratory	If it deserves	Refine and leveling	Does not require Stability  Geochemistry	Does not require Stability  Hydrological	If it deserves	Does not deserve
PB 12	Offices	If it deserves	Refine and leveling	Does not require  Geochemical stability	Does not require  Hydrological Stability	If it deserves	Does not deserve
PB 13	Dining room	If it deserves	Refine and leveling	Does not require  Geochemical stability	Does not require  Hydrological Stability	If it deserves	Does not deserve
PB 14	Changing rooms and toilets	If it deserves	Refine and leveling	Does not require  Geochemical stability	Does not require  Hydrological Stability	If it deserves	Does not deserve
PB 15	Plant substation	If it deserves	Refine and leveling	Does not require  Geochemical stability	Does not require  Hydrological Stability	If it deserves	Does not deserve
PB 16	General substation	If it deserves	Refine and leveling	Does not require Stability	Does not require Stability	If it deserves	Does not deserve

No.	Components	Closing Activities					
		Dismantling, Demolition and salvage	Physical stability	Geochemical stability	Hydrological Stability	Establishment of the shape of the land	Revegetation
				Geochemistry	Hydrological		
PB 17	Blowers	If it deserves	Refine and leveling	Does not require Stability Geochemistry	Does not require Stability Hydrological	If it deserves	Does not deserve
PB 18	House strength	If it deserves	Refine and leveling	Does not require Stability Geochemistry	Does not require Stability Hydrological	If it deserves	Does not deserve
PB 19	Mechanical and electrical maintenance workshop	If it deserves	Refine and leveling	Does not require Stability Geochemistry	Does not require Stability Hydrological	If it deserves	Does not deserve
PB 20	General storehouse	If it deserves	Refine and leveling	Does not require Stability Geochemistry	Does not require Stability Hydrological	If it deserves	Does not deserve
PB 21	Reagent store	If it deserves	Refine and leveling	Does not require Geochemical stability	Does not require Hydrological Stability	If it deserves	Does not deserve
PB 22	Reagent Preparation	If it deserves	Refine and leveling	Does not require Geochemical stability	Does not require Hydrological Stability	If it deserves	Does not deserve
PB 23	Biodigesters	If it deserves	Refine and leveling	Does not require Geochemical stability	Does not require Hydrological Stability	If it deserves	Does not deserve
PB 24	Heavy vehicle parking	Does not deserve	Refine and leveling	Does not require Geochemical stability	Does not require Hydrological Stability	If it deserves	Does not deserve
PB 25	Heavy vehicle parking	Does not deserve	Refine and leveling	Does not require Stability Geochemistry	Does not require Stability	If it deserves	Does not deserve

No.	Components	Closing Activities					
		Dismantling, Demolition and salvage	Physical stability	Geochemical stability	Hydrological Stability	Establishment of the shape of the land	Revegetation
					Hydrological		
PB 26	Light vehicle parking	Does not deserve	Refine and leveling	Does not require Stability Geochemistry	Does not require Stability Hydrological	If it deserves	Does not deserve
PB 27	Balance	If it deserves	Refine and leveling	Does not require Stability Geochemistry	Does not require Stability Hydrological	If it deserves	Does not deserve
PB 28	Fuel tank	If it deserves	Refine and leveling	Does not require Stability Geochemistry	Does not require Stability Hydrological	If it deserves	Does not deserve
PB 29	Solid waste deposit warehouse	If it deserves	Refine and leveling	Does not require Stability Geochemistry	Does not require Stability Hydrological	If it deserves	Does not deserve
PB 30	Volatilization field	If it deserves	Refine and leveling	Does not require Geochemical stability	Does not require Hydrological Stability	If it deserves	Does not deserve

Source: EIA<sub>s</sub>d, 2019.

## 20.7 Communities and social agreements

Kuya maintains a relationship with the communities within its sphere of social influence. According to what is detailed in the IGAs, the populated centers and Farming communities that are part of their area of social influence have been identified (see Table 8).

The project is located on the land of the Farming community of Poroche, and to date Kuya has an agreement with the Farming community of Poroche “Usufruct, surface and easement contract dated August 14, 2013”.

Likewise, within the approved Management Plan, the approach to local authorities and the general population of the district level has been considered. The owner seeks to promote social programs that facilitate the labor reinsertion of workers through programs of labor reconversion, training (development of technical and business skills) to the communities in the area of direct and indirect influence, in order to maintain the development of the local economy and improve the quality of life of the community.

*Table 20-10: Areas of social influence in previous IGAs*

IGA	Area of social influence	Ambit	Criteria
<b>Area 1:</b> ADIA, 2017	Direct	Farming Community of Poroche  San Jose de Acaabambilla Community	<ul style="list-style-type: none"> <li>▪ It includes the total area of the Santa Elena project, which is isolated from towns and from some very scattered ranches belonging to hamlets where they carry out grazing activities, without having contact with the exploitation area.</li> <li>▪ Community of San José de Acobambilla as rightful owner in the possession, use and enjoyment of the land and for its status as user of the water resource and access roads.</li> </ul>
	Hint	Acobambilla District	<ul style="list-style-type: none"> <li>▪ For practical purposes for the socioeconomic analysis, the area of indirect influence is established at the district level, which in this case involves the district of Acobambilla, since the collateral linear components (access roads and hydrographic basin) are located within their administrative jurisdictions.</li> </ul>
<b>Area 2:</b> EIAsd, 2019	Direct	Farming Community of Poroche	<ul style="list-style-type: none"> <li>▪ Proximity of the populations to the project area and use of accesses.</li> <li>▪ Possible significant direct environmental impacts with social repercussions.</li> <li>▪ Possible direct economic impacts, because they are populations that could benefit from some employment opportunities.</li> <li>▪ Recipients of possible social investments by the company.</li> </ul>



IGA	Area of social influence	Ambit	Criteria
			<ul style="list-style-type: none"> <li>▪ Possible direct socio-cultural impacts (impact on the uses and customs of the closest population).</li> </ul>
	Hint	Cologne District Acobambilla District	<ul style="list-style-type: none"> <li>▪ Geographic: Because they are populations adjacent to the populated centers considered as AISD, and because they are linked through the access road.</li> <li>▪ Political-administrative division: Because the main political and judicial authorities are found in the Farming Community of Poroche.</li> <li>▪ Economic income: Taking into account the increase in the budget contribution to the local, provincial and regional government as a result of the Mining Canon.</li> <li>▪ Possible indirect socio-cultural impacts.</li> </ul>

**20.7.1 Rural community of Poroche**

The project is located on the land of the rural community of Poroche, for the determination of the area of direct social influence, the geographical and geopolitical criteria have prevailed, that is, the Rural Community of Poroche, which could be directly and indirectly impacted by its activities.

The Farming community of Poroche, is located in the district of Colonia, province of Yauyos and the district of Acobambilla, province of Huancavelica, is recognized and duly registered in the Register of Rural Communities, of the Public Registries of Lima.

The community is a group of families that own and identify with a certain territory that is the Poroche property of 11,014.48 hectares; that are linked by common social and cultural traits, by communal work and mutual aid, basically by activities related to livestock and other activities that take place within the Community.

The Farming community of Poroche has registered the resolution of its recognition on January 30, 1940 with item 90096079; The titling data has a registration date of July 20, 1988.

The Farming community of Poroche is made up of the following populated centers:

- Bethania
- Chuca
- Huayruy
- Ustuna
- Sicla
- Casuy
- Poroche.

### ***20.7.2 Relationship protocols***

The Citizen Participation process contemplates a corporate Relationship Protocol (Art. 8 DS N° 028-2008-EM) whose purpose is to define procedures for the development of the activities carried out by Kuya, in a framework of transparency, dialogue and respect to social organizations in the area of influence with respect to this study.

The Community Relations Protocol contains the general common guidelines on terms of reference agreed upon between the community and the mining company.

The following components are proposals for a better performance of social management processes.

#### ***20.7.2.1 Social policy protocol***

The following provisions are part of the Code of Conduct:

- Workers must show transparent behavior, integrity and a high level of professionalism and personal responsibility using exemplary language in greeting and courtesy.
- Under no circumstances should workers carry or consume alcoholic beverages or any type of drug in the work area or during their performance in the area.
- Workers are prohibited from carrying firearms in the work area.
- Workers shall properly dispose of all waste.
- Driving above the established speed limits and traveling outside the routes established within the logistics plan is prohibited.
- Workers will make mandatory use of the personal protection equipment that their activity requires.
- If you become aware of any incident that breaks the established rules, you must report it immediately to your superior.

#### ***20.7.2.2 Sustainable development protocol***

- It seeks sustainable development with its areas of social influence.
- Ties with stakeholders involved in the area will be strengthened, thus seeking to achieve truthful and transparent communication with them.
- It will seek to contribute to the social and economic development of the areas of direct social influence.
- It will be responsible with the environment.
- To achieve sustainable development, the following factors will be taken into account:
  - Harmonious relationships: effective communication and trust.

- Excellence framework activities: social responsibility and environmental management.
- Consensual social investment: focus on the common good and fluid dialogue.
- Genuine social participation: equity and capacity development.

#### ***20.7.2.3 Social responsibility protocol***

Kuya will be responsible for the impacts that it may generate on the environment and areas of social influence, these actions will help to improve sustainable development; in this way, it seeks to generate a strategic alliance between the community and the company.

#### ***20.7.2.4 Information and communications protocol***

- The company will have a Community Relations Plan.
- The company and the area of social influence maintain transparent communication (with an open-door policy).
- The company and the community will respect their own internal decisions.

#### ***20.7.2.5 Citizen Participation Protocol***

The opinions, suggestions, arguments and/or proposals of the community will be analyzed and evaluated, to be taken into account by the company.

#### ***20.7.2.6 Interculturality***

Through the intercultural approach, it is sought that all the social actors involved with the project can strengthen their ties with the company and thus build a harmonious relationship that can be developed during the different stages of the project. During the process of interculturality, the following points will be taken into account:

- Intercultural dialogue: Through this dialogue, it is sought that the company, the State and the communities can have a diverse bond.
- Documents written in a simple way and in the most widely spoken language in the area of direct social influence, in this case, Spanish.
- Kuya will be respectful of the traditions of the area of social influence.

#### ***20.7.3 Agreements***

Finally, it is important to specify that, to date, Kuya has an agreement with the Farming Community of Poroche "Usufruct, surface and easement contract dated August 14, 2013" for the use of surface land in which it assumes:

- Maintain an adequate social environment that makes the development of the company's activities viable.
- Do not disturb the use of surface areas, accesses and roads that are required for the development of mining activities, allowing their free and peaceful use for their benefit.
- Allow and facilitate the company or whoever it designates the transit and access to the surface land, granting it all the necessary facilities and allowing the construction of additional access roads to said surface land, if applicable.
- Provide unskilled labor for detailed maintenance of mining activities and the company.
- Provide additional space within the Community for the construction and operation of the company's sedimentation ponds.

The Company has developed and maintained good positive relationships with the Project's stakeholders, including a land usage agreement with the local Poroche community. The agreements include a royalty payment of \$0.25/t + VAT on mined material from the Bethania concession and \$0.75/t + VAT for every tonne treated at the Bethania plant.

## 21 CAPITAL AND OPERATING COSTS

### 21.1 Introduction

This PEA considers the viability of a low-CAPEX start-up for Santa Elena with a conventional underground mine and a processing plant designed to treat 350 tonnes per day (“tpd”).

The Start-up Capital Costs are defined as those costs required to achieve 350 tpd (“Start Up Capital”). Capital cost estimates have been revised by the following parties as part of the 2021 PEA:

- a. Mining Plus: Mining related costs and onsite infrastructure costs.
- b. M3: Process plant costs.
- c. KCB: Mine waste disposal costs.

All currencies are reported in U.S. dollars (US\$), unless otherwise specified.

### 21.2 Capital Cost Estimate Summary

A summary of the Santa Elena capital cost estimates is shown in Table 21-1.

*Table 21-1: Total Capital Cost Estimate*

Description	US\$	US\$	US\$
	Initial CAPEX	Sustaining CAPEX	Total CAPEX
Mine	\$2.4M	\$2.7M	\$5.2M
Process Plant	\$6.6M	\$0.0M	\$6.6M
Tailings and Waste Rock Disposal	\$3.2M	\$0.8M	\$4.0M
Surface Components	\$1.3M	\$0.0M	\$1.3M
Owner’s Costs	\$0.7M	\$0.0M	\$0.7M
Mine Closure	\$0.0M	\$1.9M	\$1.9M
<b>Total Capital Cost Pre - Contingency</b>	<b>\$14.2M</b>	<b>\$5.4M</b>	<b>\$19.6M</b>
Contingency Costs (25%)	\$3.6M	\$1.4M	\$4.9M
<b>Total Initial Capital Cost</b>	<b>\$17.8M</b>	<b>\$6.8M</b>	<b>\$24.5M</b>

### 21.3 Basis for the estimate – Capital Cost

The capital cost estimate has been developed to provide an estimate suitable for the 2022 PEA, including costs to design, procure, construct, and commission the facilities. The expected accuracy range of the capital cost estimate is +25%/-30%.

## 21.4 Mine Capital Cost

The capital cost estimate has been developed to provide an estimate suitable for the PEA, including costs to design, procure, construct, and commission the facilities.

The PEA estimates an initial CAPEX of US\$17.8M to start with a design production capacity of 350 tpd with a 25% contingency (applied to Mine, Plant, Tailings, others).

The PEA estimates a Total CAPEX of US\$24.5M with a 25% contingency (applied to Mine, Plant, Tailings, others).

## 21.5 Process Plant and Infrastructure Capital Cost.

The process plant capital costs are based on a vendor quotation.

The direct costs for the plant capital cost considers the aspects of:

- Earthwork.
- Concrete.
- Structural Steel.
- Architectural.
- Mechanical.
- Pipelines.
- Electrical.
- Instrumentation.

These aspects are broken down into:

- Construction Equipment.
- Materials.
- Permanent (Plant) Equipment.
- Installation (Labor).

Indirect costs include:

- Procurement Management.
- General Expenses of the Contractor.
- Contractor Utility (Profit).
- Precommissioning and Commissioning support.
- Freight and Transportation.
- Risk Allocation.



Table 21-2: Plant Capital Cost Estimates

Description	US\$
Mechanical	3,326,150
Pipelines	431,476
Electrical	1,769,662
Instrumentation	347,768
<b>Direct Cost</b>	<b>5,875,056</b>
Procurement Management	26,360
General Expenses of the Contractor	287,290
Contractor Utility	131,141
Precommissioning and Commissioning	61,950
Freight and Transportation	75,600
Risk Allocation	95,148
<b>Indirect Cost</b>	<b>677,489</b>
<b>Total Cost</b>	<b>6,552,545</b>
Contingency (25%)	1,638,136
<b>CAPEX Plant with Contingency</b>	<b>8,190,681</b>

## 21.6 Tailings Capital Cost

The tailings capital costs is based on a vendor quotation and includes the following:

- Preliminary works
- Earth works
- Geosynthetics
- Pipelines
- Water Management
- Precision equipment
- Pumps
- Concrete works.

Table 21-3: Tailings Capital Cost Estimates

Item	Description		Direct Cost
1	Preliminary works	US\$	138,380
2	Earth works	US\$	1,787,050
3	Geosynthetics	US\$	343,397
4	Pipelines	US\$	71,641
5	Water Management	US\$	7,177
6	Precision equipment	US\$	112,264
7	Pumps	US\$	176,662
8	Concrete works	US\$	22,222
<b>Total Direct Cost</b>		<b>US\$</b>	<b>2,658,793</b>

Item	Description		Direct Cost
	General Expenses (14%)	US\$	372,231
	Utilities (6%)	US\$	159,528
	COVID Implementation Expenses	US\$	49,274
	<b>Net Total</b>	<b>US\$</b>	<b>3,239,826</b>
	Sustaining	US\$	800,000
	<b>Total CAPEX</b>	<b>US\$</b>	<b>4,039,826</b>

### 21.7 Owner’s Cost

MP estimated owner’s costs based on their experience operating a similar mining projects. Estimated owner’s costs include insurance, camp costs, safety, and training.

### 21.8 Operating Cost Estimate Summary

The Technical Report (PEA) contemplates an underground mine from which mineralized material will be trucked to the plant.

Operating cost estimates have been developed to provide an estimate suitable for a PEA, including costs for mining and processing. The expected accuracy range of the operating cost estimate is +25%/-30%. For treatment and refining costs market rates provided by the Company from a November 2021 market study were used.

Life of Mine (“LOM”) operating costs are summarized in Table 21-4.

Table 21-4: Estimate Life of Mine Operating Cost

Operating Costs	LOM (US\$)	\$/tonne processed
Mining	\$31.4M	36.67
Processing	\$20.6M	25.72
Third party processing cost	\$1.4M	
Tailings	\$0.5M	0.59
Onsite G&A	\$14.1M	16.49
<b>Total Operating Costs</b>	<b>\$68.1M</b>	<b>79.46</b>
Treatment & Refining Charges	\$33.9M	39.54
Community Participation	\$0.9M	1.00
<b>Total Cash Costs</b>	<b>\$102.8M</b>	<b>120.01</b>
Sustaining Costs	\$3.4M	4.13
<b>All-in Sustaining Costs (AISC)</b>	<b>\$106.2M</b>	<b>124.14</b>

(1) Includes mine development and stope production.

Operating cost estimates have been developed to provide an estimate suitable for the Technical Report (PEA), including costs for mining, processing, and waste disposal.

Contingencies have not been considered when estimating operating costs.

## 21.9 Mining Operating Cost

Estimated operating cost (“OPEX”) consider proposed mine plan, local cost benchmarking and experience from similar operations and local conditions. It has been envisaged that mining operations will be carried out by a contractor.

### 21.9.1 Mining Cost

Estimated mining costs consider the following aspects:

- Horizontal Development + preparation (US\$/m).
- Vertical Development + preparation (US\$/m).
- Stopes Production (US\$/t).

A breakdown of the calculated costs is presented in Table 21-5.

Table 21-5: Estimated Mine Operating Costs

	Development (m)	Cost per meter (US\$)	Total Cost (US\$)
Horizontal Development meters	14,035	338	\$4,740,756
Vertical Development meters	5,014	273	\$1,370,911
Contingency (water pumping)			\$176,758
<b>Total (US\$)</b>			<b>\$6,288,426</b>

	Stope Tonnes (t)	Cost per tonne (US\$)	Total Cost (US\$)
Stopes Production Tonnes (t)	517,312	48.60	\$25,139,152
<b>Total (US\$)</b>			<b>\$25,139,152</b>

<b>Total Mining Cost (US\$)</b>			<b>\$31,427,578</b>
---------------------------------	--	--	---------------------

<b>Total Mineralized Material (t)</b>			<b>857,078</b>
---------------------------------------	--	--	----------------

<b>Cost Per Tonne (US\$/t)</b>			<b>\$36.67</b>
--------------------------------	--	--	----------------

### 21.9.2 Mine Supervision Costs

Estimated labour costs have been developed based on KS experience running a mining operation in Peru. Estimated labour costs consider local labour rates and overheads.

Estimated mine supervision costs consider the following roles and a total of 24 people. Estimated mine supervision costs have been summarized in *Table 21-6*.

Table 21-6: Estimated Mine Personnel Costs

Department	Position	Count
Mine Management	Mine Manager	1
Mining	Mine Chief	1
	Chief Mine Guard	2
	General Foreman	3
	Surveyor	2
	Surveyor's assistant	2
Productivity	Data processor	1
	Design draftsman	1
	Geotech Inspector	1
	Ventilation Inspector	1
Maintenance	Mechanic - Electrical Chief	1
	Electrical Supervisor Level 1	1
	Electrical Supervisor Level 2	1
	General Mechanic	1
	Drill mechanic (Jackleg)	3
	Compressor operator	3
<b>Total</b>		<b>25</b>

### 21.10 Processing Operating Cost

- Labor (\$8.78/MT Mineralized Material): headcounts are lower than anticipated but discussed with the client to be sufficient for their operating philosophy and labor requirements in Peru.
- Power (\$5.00/MT Mineralized Material): currently using \$0.07 per kWh which is reasonable to assume for line power in Peru.
- Reagents (\$5.53/MT Mineralized Material): consumptions and rates were confirmed by the client based on recent quotes.
- Wear Parts (\$1.49/MT Mineralized Material)
- Maintenance & Supplies (\$2.52/MT Mineralized Material)
- Facilities (\$1.94/MT Mineralized Material)
- Total OPEX (\$25.26/MT Mineralized Material).

### 21.11 Third party processing cost

An assumption of \$35/t for third party processing expenses was used for the Toll-Milling Option. This is only applicable for year 0, and the combined processing cost is (\$25.26/MT Mineralized Material).

### 21.12 Tailings Operating Cost

The tailings operating costs include only spare parts and energy. As it is a small site the labor is shared between the plan and the tailings, and the remuneration cost is allocated to the plant.

Table 21-7: Tailings Operating Costs

Description		Unit Cost
Remuneration		Included in Plant Cost
Spare Parts	US\$/t	0.29
Energy	US\$/t	0.27
<b>Subtotal</b>	<b>US\$/t</b>	<b>0.56</b>
Others	US\$/t	0.03
<b>Total</b>	<b>US\$/t</b>	<b>0.59</b>

### 21.13 Onsite G&A

Onsite General and Administrative (“G&A”) costs have been estimated for the following work areas:

- Administration
- Environmental Affairs
- Community Relations
- Security
- Communications allowance
- Office supplies, office maintenance etc
- Light vehicles
- Social relations costs
- Insurance.

### 21.14 Treatment & Refining Charges

The refining cost is estimated per concentrate:

- Copper Concentrate:
  - Treatment cost: 240 US\$/t
  - Refining cost: 0.08 US\$/lb
  - Selling cost: 157.44 US\$/t
- Lead Concentrate
  - Treatment cost: 260 US\$/t
  - Selling cost: 157.44 US\$/t
- Zinc Concentrate.
  - Treatment cost: 330 US\$/t
  - Selling cost: 157.44 US\$/t

## 22 ECONOMIC ANALYSIS

---

### 22.1 Cautionary Statements

Certain information and statements contained in this section and elsewhere in the Technical Report are “forward looking” in nature.

All forward-looking statements in this Technical Report are necessarily based on opinions and estimates made as of the date such statements are made and are subject to important risk factors and uncertainties, many of which cannot be controlled or predicted.

Material assumptions regarding forward-looking statements are discussed in this Report, where applicable. In addition to, and subject to, such specific assumptions discussed in more detail elsewhere in this Report, the forward-looking statements in this Technical Report are subject to the following assumptions:

The production schedules and financial analysis annualized cash flow table are presented with conceptual years shown. Years shown in these tables are for illustrative purposes only. If additional mining, technical, and engineering studies are conducted, these may alter the project assumptions as discussed in this Technical Report and may result in changes to the calendar timelines presented.

This PEA is preliminary in nature. The preliminary economic analysis is partly based on Inferred Mineral Resources that are considered too speculative geologically to have the economic considerations applied to them that would enable them to be categorized as Mineral Reserves, and there is no certainty that the PEA based on these Mineral Resources will be realized.

The proposed mine plan is based on a 36% indicated resources and 64% inferred resources. There is historically a higher risk of project failure if the PEA is used as basis for making a production decision.

### 22.2 Methodology Used

The financial analysis was carried out using a discounted cash flow (DCF) methodology. Net annual cash flows were estimated projecting yearly cash inflows (or revenues) and subtracting projected yearly cash outflows (such as capital and operating costs, royalties, and taxes). These annual cash flows were discounted back to the date of beginning of capital expenditure at mid-year 2022 and totaled to determine the NPV of the project at selected discount rates. Pre-production (year 0) also allows generation of income, once the existing development is rehabilitated and accessible, it will allow mining during the pre-production year and the material will be processed in a third-party plant until the project plant is active and operational in 2023.



A discount rate of 5% was used as the base discounting rate.

In addition, the IRR, expressed as the discount rate that yields an NPV of zero, and the payback period, expressed as the estimated time from the start of production (end of year 0) until all initial capital expenditures have been recovered, were also estimated.

Sensitivities to variations in silver price, initial capital costs and operating costs were carried out to identify potential impacts on NPV and IRR.

### 22.3 Principal Assumptions

A financial model was completed based on the mine plan, which assumes the commencement of production in 2023 with a mine production at 350 tpd, in addition to other inputs such as mining inventory and rates, processing throughputs and metallurgical recoveries, capital and operating costs, royalties, government royalty and taxation parameters.

By including the Toll-Milling Option in the analysis preproduction (Year 0) income is generated prior to the completion of the processing facility.

#### 22.3.1 Mineral Resource, Mine Plan, and Mine Life

The PEA mine plan is based on the subset of Mineral Resources stated in Section 14, with the subset discussed in Section 16.

Indicated Mineral Resources account for 36% of total mill feed and Inferred Mineral Resources for 64% of total mill feed.

The forecast mine and mill feed schedules were included in Section 16.

#### 22.3.2 Metallurgical Recoveries

Table 22-1 presents the summary of the metallurgical recovery for the project.

Table 22-1: Metallurgical Recoveries

	Unit	Value
Cu Recovery	%	64%
Pb Recovery	%	90%
Zn Recovery	%	81%
Ag inc Pb	%	80%
Ag inc Cu	%	11%
Au inc Pb	%	29%
Au inc Cu	%	5%

### 22.3.3 Metal Prices

In the financial model the following metal prices were used.

- Price Ag: 25.4 US\$/oz
- Price Pb: 0.9 US\$/lb
- Price Cu: 3.62 US\$/lb
- Price Zn: 1.21 US\$/lb
- Price Au: 1,850 US\$/oz

### 22.3.4 Discount Rate

The net present value (“NPV”) was calculated from the cash flow generated by the project using a base discount rate of 5%. The discount rate was selected based on a benchmark analysis of recent mining project reports in Peru and other similar projects in Latin America provided by Kuya. It considers risks associated with the project, commodity prices and country risks.

### 22.3.5 Capital Costs

Capital cost assumptions are outlined in Section 21. A rehabilitation period of 06 months was considered (starting in 2022). In the middle of the year 0 the development, preparation and mining of stopes begins. Year 2023 corresponds to the first year of production at a rate of 350 tpd. Capital costs were applied in the financial model excluding IGV/GST (IGV is the General Sales Tax in Peru).

Initial Capital Costs include mine development and plant construction with a design capacity of 350 tonnes per day (“tpd”) are shown in Table 22-2.

Table 22-2: Total Capital Cost

Description	US\$	US\$	US\$
	Initial CAPEX	Sustaining CAPEX	Total CAPEX
Mine	\$2.4M	\$2.7M	\$5.2M
Process Plant	\$6.6M	\$0.0M	\$6.6M
Tailings and Waste Rock Disposal	\$3.2M	\$0.8M	\$4.0M
Surface Components	\$1.3M	\$0.0M	\$1.3M
Owner’s Costs	\$0.7M	\$0.0M	\$0.7M
Mine Closure	\$0.0M	\$1.9M	\$1.9M
<b>Total Capital Cost Pre - Contingency</b>	\$14.2M	\$5.4M	\$19.6M
Contingency Costs (25%)	\$3.6M	\$1.4M	\$4.9M
<b>Total Initial Capital Cost</b>	<b>\$17.8M</b>	<b>\$6.8M</b>	<b>\$24.5M</b>

### **22.3.6 Sustaining Capital**

Sustaining Capital costs have been applied. All mine development beyond the initial capital costs is considered an operating cost.

### **22.3.7 Operating Costs**

Operating cost assumptions are outlined in Section 21. For the purpose of this PEA, it has been assumed that the mine will be operated by a contractor. Operating costs were applied in the financial model excluding IGV (IGV is the General Sales Tax in Peru).

### **22.3.8 Closure Costs and Salvage Value**

A provision of US\$1.9M was included to account for closure costs. Closure costs have been considered as part of the G&A cost and are contributed to annually.

No salvage value was considered.

### **22.3.9 Financials**

The Cashflow, Net Present Value (“NPV”) and Internal Rate of Return (“IRR”) before-tax and after-tax in the PEA do not include any debt service payments.

### **22.3.10 Inflation**

No escalation or inflation has been applied. All amounts are in real (constant) terms.

### **22.3.11 Financials**

- Base case (\$25.40/oz silver price) Pre-Tax NPV (5%) of \$77.8 million and IRR of 227%.
- Base case (\$25.40/oz silver price) After-Tax NPV (5%) of \$54.7 million and IRR of 188%.
- Pre-production toll milling option would generate gross margin of \$9.5 million during construction at base case, would accelerate after-tax payback period to 0.50 years.
- After-tax cash flow of \$18.04 million in first full year of production (base case)
- Life of Mine ("LOM") after-tax free cash flow of \$65.3 million (base case).
- Initial Capital Cost Estimated at \$14.2 million plus 25% contingency of \$3.6 million.
- All-In Sustaining Costs of \$10.48/oz silver eq. in first year, \$12.15/oz silver eq. over LOM.
- Silver production of 1.37 million oz eq. in first year, 8.68 million oz eq. over LOM

- Production (head) grade of 13.8 oz/t (or 429 g/t) silver eq. in pre-production year, 10.1 oz/t (or 315 g/t) silver eq. over LOM.

Average Silver recovery is:

- Silver in Lead concentrate: 80%
- Silver in Copper concentrate: 11%.

Average Copper recovery is 64%, Lead recovery is 90 % and Zinc recovery is 81%.

### 22.3.12 Taxes and other government levies

The following outlines the main taxation considerations applied in the financial model, according to the Peruvian tax regime for mining companies:

- (i) A standard corporate tax rate of 29.5% is applied to taxable income,
- (ii) A special mining tax is applied to operating profit resulting from the mining activity; the effective rate is calculated based on the operating margin and ranges between 3 to 4 %; and
- (iii) Workers’ profit participation of 8% is applied to taxable income.

### 22.3.13 Cash Flow Forecasts

The cash flow forecast on an annual basis is presented in Table 22-3.

Table 22-3: Summary Cash Flow forecast (before taxes)

Units/Year	0 (*)	1	2	3	4	5	6	7	Total
USD	-8,297.8	20,319.7	14,997.9	16,759.3	19,170.9	14,413.8	11,217.5	4,576.5	93,157.6

The NPV, IRR, and payback period are presented in Table 22-4.

Table 22-4: The net present value (NPV), internal rate of return (IRR), and payback period

Economics Summary	Pre-Tax (US\$)	After-Tax (US\$)
NPV 5 %	\$77,824	\$54,730
IRR	227%	188%
Payback	0.4	0.5
LOM Cash Flow	\$93,158	\$65,349

The Operating Cost Estimate per tonne and per ounce are presented in Table 22-5.

Total Operating Costs consist of mining and processing costs, tailings and waste rock disposal and on-site G&A.

Total Cash Costs consist of operating costs plus treatment and refining charges, government and NSR royalties and community interest is 0.25 US\$/t extracted y 0.75 US\$/t treated.

All-in Sustaining Costs (AISC) consist of cash costs plus sustaining capital (mining and processing).

Table 22-5: Operating Cost Estimate per tonne

Operating Costs	LOM (US\$)	\$/tonne processed
Mining	\$31.4M	36.67
Processing	\$20.6M	25.72
Third party processing cost	\$1.4M	
Tailings	\$0.5M	0.59
Onsite G&A	\$14.1M	16.49
<b>Total Operating Costs</b>	<b>\$68.1M</b>	<b>79.46</b>
Treatment & Refining Charges	\$33.9M	39.54
Community Participation	\$0.9M	1.00
<b>Total Cash Costs</b>	<b>\$102.8M</b>	<b>120.01</b>
Sustaining Costs	\$3.4M	4.13
<b>All-in Sustaining Costs (AISC)</b>	<b>\$106.2M</b>	<b>124.14</b>

Table 22-6: Production and Cost Profile by Year

Year	0 (*)	1	2	3	4	5	6	7
<b>Production (mt)</b>	<b>40</b>	<b>125</b>	<b>126</b>	<b>126</b>	<b>126</b>	<b>126</b>	<b>126</b>	<b>61</b>
Total Cash Costs (US\$)	\$4,583	\$14,236	\$14,784	\$14,774	\$16,025	\$15,223	\$14,754	\$7,595
All-in Sustaining Costs (AISC)	\$4,583	\$14,389	\$15,622	\$14,961	\$16,790	\$16,419	\$15,004	\$7,748
Oz Eq- Ag (moz)	554	1,373	1,219	1,256	1,428	1,261	1,071	520
\$/oz	8.27	10.48	12.82	11.92	11.76	13.02	14.01	14.90

Figure 22-1: Production and Cost Profile by Year. Own elaboration.

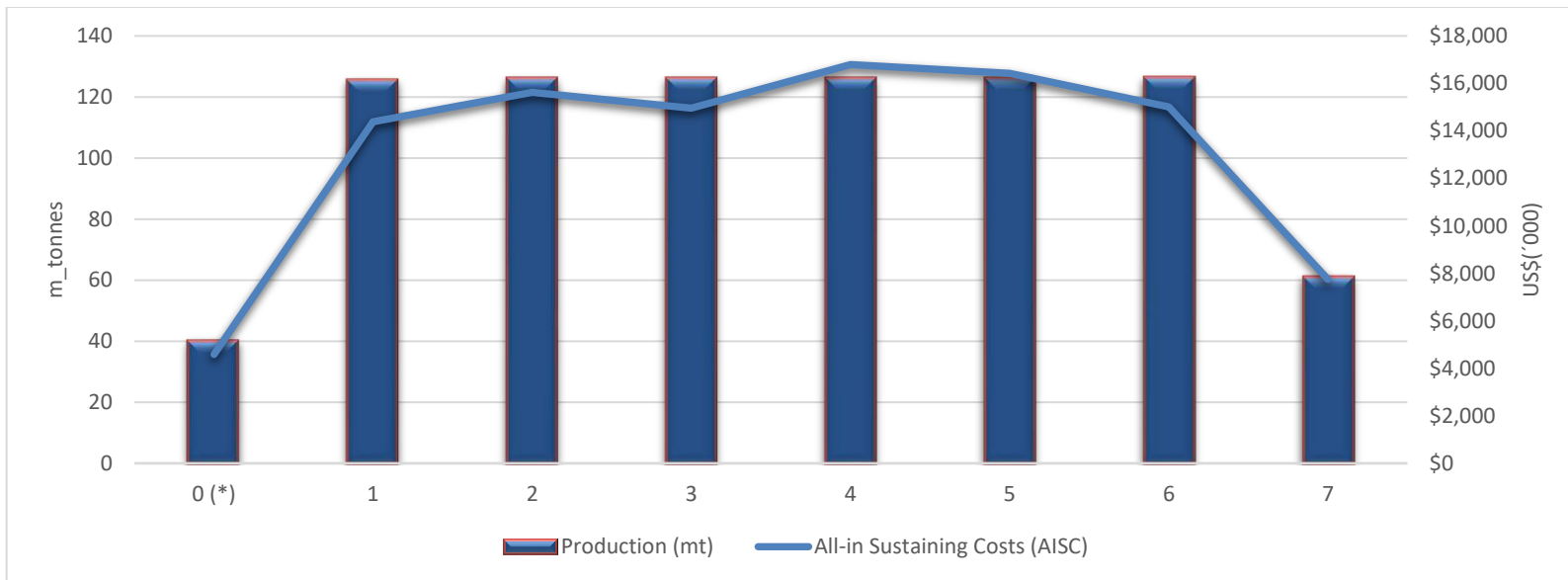



Table 22-7: Cash Flow Forecasts

	Units/Year	0 (*)	1	2	3	4	5	6	7	Total
<b>Mine Production</b>										
Total Mineralized Material	Tonnes ('000)	40.1	125.5	126.0	126.0	126.0	126.0	126.3	61.1	<b>857</b>
% Cu	%	0.14%	0.11%	0.12%	0.14%	0.15%	0.14%	0.09%	0.08%	<b>0.12%</b>
% Pb	%	2.11%	2.57%	2.17%	2.15%	2.96%	2.37%	1.92%	2.07%	<b>2.32%</b>
% Zn	%	1.93%	1.27%	1.54%	1.53%	1.69%	1.80%	1.45%	1.25%	<b>1.54%</b>
Ag (oz/t)	oz/t	12.31	9.23	7.81	8.12	8.90	7.77	6.81	6.87	<b>8.21</b>
Au (g/t)	g/t	0.15	0.16	0.19	0.21	0.25	0.24	0.17	0.22	<b>0.20</b>
Contained Cu	mlb	126.4	313.9	346.4	396.4	403.9	382.1	239.9	102.6	<b>2,311.6</b>
Contained Pb	mlb	1,864.5	7,116.5	6,023.5	5,975.5	8,220.9	6,580.8	5,343.4	2,789.7	<b>43,914.7</b>
Contained Zn	mlb	1,708.6	3,526.2	4,285.6	4,237.4	4,697.4	4,998.9	4,026.3	1,680.1	<b>29,160.4</b>
Contained Silver	moz	494.1	1157.9	984.0	1023.2	1122.1	979.0	859.3	419.9	<b>7,039.6</b>
Contained Gold	moz	0.2	0.7	0.8	0.9	1.0	1.0	0.7	0.4	<b>5.6</b>
Mining Rate tpd	tpd	223	348	350	350	350	350	351	170	
<b>Plant Production</b>										
Cu Recovery	%	64%	64%	64%	64%	64%	64%	64%	64%	<b>64%</b>
Pb Recovery	%	90%	90%	90%	90%	90%	90%	90%	90%	<b>90%</b>
Zn Recovery	%	81%	81%	81%	81%	81%	81%	81%	81%	<b>81%</b>
Ag inc Pb	%	80%	80%	80%	80%	80%	80%	80%	80%	<b>80%</b>
Ag inc Cu	%	11%	11%	11%	11%	11%	11%	11%	11%	<b>11%</b>
Au inc Pb	%	29%	29%	29%	29%	29%	29%	29%	29%	<b>29%</b>
Au inc Cu	%	5%	5%	5%	5%	5%	5%	5%	5%	<b>5%</b>
Cu Concentrate Grade %	%	20%	20%	20%	20%	20%	20%	20%	20%	<b>20%</b>
Pb Concentrate Grade %	%	60%	60%	60%	60%	60%	60%	60%	60%	<b>60%</b>
Zn Concentrate Grade %	%	50%	50%	50%	50%	50%	50%	50%	50%	<b>50%</b>
<b>Recovered Cu</b>	mlb	80.6	200.2	221.0	252.8	257.6	243.7	153.0	65.4	<b>1,474.3</b>

	Units/Year	0 (*)	1	2	3	4	5	6	7	Total
Recovered Silver	mlb	56.7	132.9	113.0	117.5	128.8	112.4	98.7	48.2	<b>808.1</b>
Recovered Gold	moz	0.0	0.0	0.0	0.0	0.0	0.0	0.0	0.0	<b>0.3</b>
<b>Recovered Pb</b>	mlb	1,680.3	6,413.4	5,428.4	5,385.1	7,408.7	5,930.6	4,815.4	2,514.1	<b>39,575.9</b>
Recovered Silver	moz	395.9	927.6	788.3	819.7	898.9	784.3	688.4	336.4	<b>5,639.4</b>
Recovered Gold	moz	0.1	0.2	0.2	0.3	0.3	0.3	0.2	0.1	<b>1.6</b>
<b>Recovered Zn</b>	mlb	1,379.2	2,846.3	3,459.4	3,420.4	3,791.7	4,035.1	3,250.0	1,356.2	<b>23,538.3</b>
<b>Total Recovered Silver</b>	mlb	452.6	1,060.6	901.2	937.2	1,027.7	896.7	787.1	384.6	<b>6,447.6</b>
Copper concentrate	mt	0.2	0.5	0.5	0.6	0.6	0.6	0.3	0.1	<b>3.3</b>
Lead concentrate	mt	1.3	4.8	4.1	4.1	5.6	4.5	3.6	1.9	<b>29.9</b>
Zinc concentrate	mt	1.3	2.6	3.1	3.1	3.4	3.7	2.9	1.2	<b>21.4</b>
<b>Payable Metal</b>										
Payable Cu	mlb	76.2	189.2	208.8	238.9	243.4	230.3	144.6	61.8	<b>1,393.3</b>
Payable Pb	mlb	1,596.3	6,092.7	5,156.9	5,115.8	7,038.2	5,634.1	4,574.7	2,388.4	<b>37,597.1</b>
Payable Zn	mlb	1,158.5	2,390.9	2,905.9	2,873.2	3,185.0	3,389.5	2,730.0	1,139.2	<b>19,772.1</b>
Ag en Pb Conc	moz	376.1	881.2	748.9	778.7	853.9	745.1	654.0	319.6	<b>5,357.5</b>
Ag en Cu Conc	moz	52.2	122.3	103.9	108.1	118.5	103.4	90.8	44.3	<b>743.5</b>
Au en Pb Conc	moz	0.0	0.2	0.2	0.2	0.2	0.2	0.2	0.1	<b>1.3</b>
Au en Cu Conc	moz	0.0	0.0	0.0	0.0	0.0	0.0	0.0	0.0	<b>0.2</b>
<b>Metal Prices</b>										
Copper	\$/lb	3.6	3.6	3.6	3.6	3.6	3.6	3.6	3.6	<b>3.6</b>
Lead	\$/lb	0.9	0.9	0.9	0.9	0.9	0.9	0.9	0.9	<b>0.9</b>
Zinc	\$/lb	1.2	1.2	1.2	1.2	1.2	1.2	1.2	1.2	<b>1.2</b>
Silver	\$/oz	25.4	25.4	25.4	25.4	25.4	25.4	25.4	25.4	<b>25.4</b>
Gold	\$/oz	1,850.0	1,850.0	1,850.0	1,850.0	1,850.0	1,850.0	1,850.0	1,850.0	<b>1,850.0</b>

	Units/Year	0 (*)	1	2	3	4	5	6	7	Total
<b>Revenue per Metal Price</b>										
Copper	mUSD	275.5	684.1	755.0	863.8	880.2	832.6	522.7	223.5	<b>5,037.5</b>
Lead	mUSD	1,435.1	5,477.5	4,636.2	4,599.3	6,327.6	5,065.2	4,112.8	2,147.2	<b>33,800.9</b>
Zinc	mUSD	1,397.3	2,883.7	3,504.8	3,465.4	3,841.5	4,088.1	3,292.7	1,374.0	<b>23,847.5</b>
Silver	mUSD	10,877.5	25,489.8	21,660.5	22,524.6	24,700.2	21,551.3	18,916.9	9,243.2	<b>154,964.0</b>
Gold	mUSD	96.5	337.5	398.4	440.6	529.4	503.2	346.9	218.0	<b>2,870.4</b>
<b>Total Revenue</b>	<b>mUSD</b>	<b>14,082</b>	<b>34,873</b>	<b>30,955</b>	<b>31,894</b>	<b>36,279</b>	<b>32,040</b>	<b>27,192</b>	<b>13,206</b>	<b>220,520</b>
<b>Costs</b>										
Mining Cost	mUSD	1,307.7	5,961.8	6,731.3	6,670.3	6,962.6	6,724.9	7,215.0	3,987.9	<b>45,561.6</b>
Plant Cost	mUSD	1,405.0	3,168.9	3,183.4	3,183.7	3,183.7	3,183.7	3,189.5	1,542.8	<b>22,040.8</b>
Tailing Cost	mUSD	0.0	73.9	74.2	74.2	74.2	74.2	74.4	36.0	<b>481.2</b>
Treatment Cost	mUSD	1,870.7	5,031.3	4,795.3	4,845.9	5,804.2	5,240.2	4,275.1	2,028.0	<b>33,890.6</b>
Community	mUSD	40.1	125.5	126.0	126.0	126.0	126.0	126.3	61.1	<b>857.1</b>
<b>Sustaining Costs</b>										
Mining	mUSD	0.0	153.3	837.4	187.3	365.8	996.1	49.5	14.0	<b>2,603</b>
Tailings	mUSD	0.0	0.0	0.0	0.0	400.0	200.0	200.0	0.0	<b>800</b>
<b>Net Operating</b>	<b>mUSD</b>	<b>9,458</b>	<b>20,358</b>	<b>15,207</b>	<b>16,806</b>	<b>19,362</b>	<b>15,495</b>	<b>12,062</b>	<b>5,536</b>	<b>114,286</b>
<b>CAPEX</b>										
Plant	mUSD	6,550.0	0.0	0.0	0.0	0.0	0.0	0.0	0.0	<b>6,550.0</b>
Tailings	mUSD	3,246.8	0.0	0.0	0.0	0.0	0.0	0.0	0.0	<b>3,246.8</b>
Mining	mUSD	2,431.7	0.0	0.0	0.0	0.0	0.0	0.0	139.2	<b>2,570.8</b>
Surface Components	mUSD	1,300.0	0.0	0.0	0.0	0.0	0.0	0.0	0.0	<b>1,300.0</b>
Contingency	mUSD	3,551.2	38.3	209.3	46.8	191.5	455.5	218.9	160.0	<b>4,871.5</b>
Owners Cost	mUSD	676.4	0.0	0.0	0.0	0.0	625.9	625.9	625.9	<b>2,554.1</b>

	Units/Year	0 (*)	1	2	3	4	5	6	7	Total
<b>Cash Flow Pre-Tax</b>	<b>USD</b>	<b>-8,298</b>	<b>20,320</b>	<b>14,998</b>	<b>16,759</b>	<b>19,171</b>	<b>14,414</b>	<b>11,217</b>	<b>4,611</b>	<b>93,192</b>
<b>Taxes</b>		0.0	2,283.9	4,479.4	4,781.6	5,859.6	5,171.2	3,765.1	1,471.6	27,812.5
<b>Cash Flow After -Tax</b>	<b>USD</b>	<b>-8,298</b>	<b>18,036</b>	<b>10,519</b>	<b>11,978</b>	<b>13,311</b>	<b>9,243</b>	<b>7,452</b>	<b>3,140</b>	<b>65,380</b>

## 22.4 Sensitivity analysis

Sensitivities of pre-tax and post-tax NPV and IRR to silver prices per ounce are presented in Table 22-8.

Table 22-8: Economic Sensitivity to Silver Price

		80% Price Ag Price Ag = 20.32 \$/oz	90% Price Ag Price Ag = 22.86 \$/oz	Price Ag Price Ag = 25.4 \$/oz	110% Price Ag Price Ag = 27.94 \$/oz	120% Price Ag Price Ag = 30.48\$/oz
Pre - Tax	NPV (5%)	\$51.9M	\$64.9M	\$77.8M	\$90.8M	\$103.7M
	IRR	130%	173%	227%	298%	392%
	Payback	0.68	0.53	0.41	0.32	0.24
After - Tax	NPV (5%)	\$37.7M	\$46.2M	\$54.7M	\$63.2M	\$71.7M
	IRR	116%	148%	188%	237%	304%
	Payback	0.7	0.6	0.5	0.4	0.3

The pre-tax and post-tax Economic Sensitivity to discount rate is shown in Table 22-9.

Table 22-9: Economic Sensitivity to discount rate

Parameter	Unit	Amount (US\$)
<b>Net Cash Flow before tax</b>		
NPV @ 5% real (before tax)	US\$	\$77,824
NPV @ 8% real (before tax)	US\$	\$70,319
NPV @ 10% real (before tax)	US\$	\$65,885
IRR (before tax)	%	227%
Payback (before tax)	Years	0.4
<b>Net Cash Flow after tax</b>		
NPV @ 5% real (after tax)	US\$	\$54,730
NPV @ 8% real (after tax)	US\$	\$49,513
NPV @ 10% real (after tax)	US\$	\$46,423
IRR (before tax)	%	188%
Payback (before tax)	Years	0.5

The After-Tax Economic Sensitivity to Metal Price, Operating and Initial Capital Costs is shown in Figure 22-2.

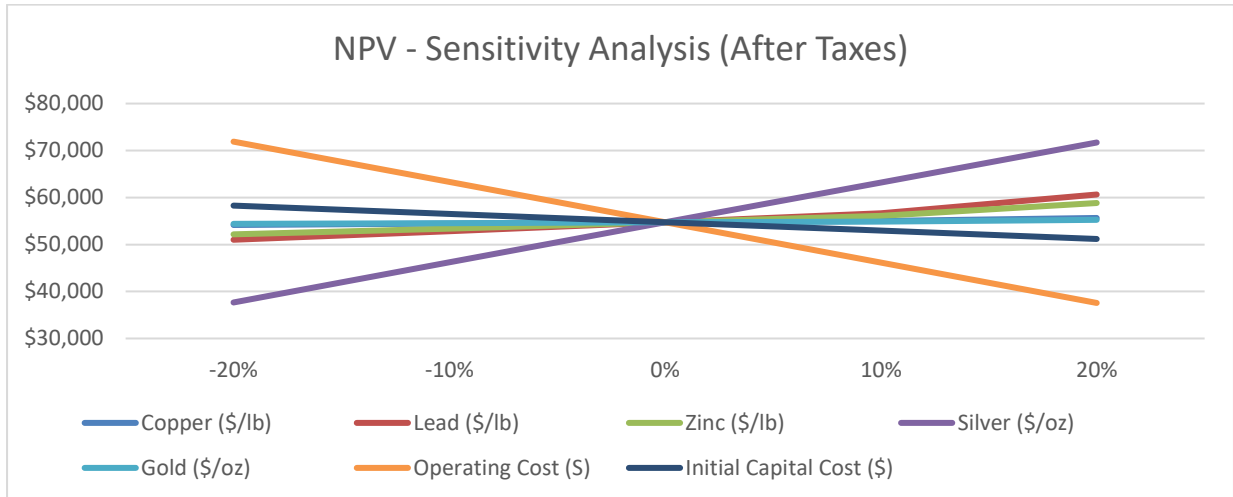

Figure 22-2: After-Tax Economic Sensitivity to Metal Price, Operating and Initial Capital Costs. Own elaboration.

The Before-Tax Economic Sensitivity to Metal Price, Operating and Initial Capital Costs is shown in Figure 22-3.

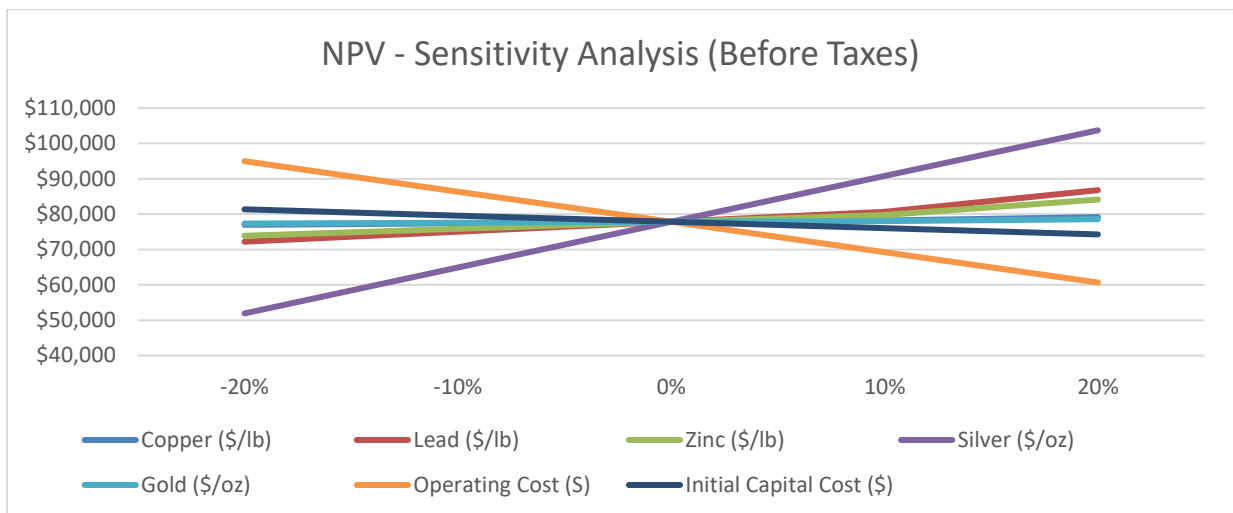

Figure 22-3: Before-Tax Economic Sensitivity to Metal Price, Operating and Initial Capital Costs. Own elaboration.



## 23 ADJACENT PROPERTIES

The Authors have been unable to verify the following information and data. Data and information presented below is not necessarily indicative of the mineralization on the Property that is the subject of the Report.

A review of Minera IRL’s website information in relation to Corihuarmi Mine together with preliminary reporting regarding Kuya’s exploration concessions surrounding the Bethania mine, and examination of Google Earth (2021) satellite imagery, shows several small mines and mining trials within the interpreted collapsed caldera and within a 4 km radius (Figure 23-1).

The Table 23-1 and Figure 23-1 shows the limits of the Kuya Silver Project on the surroundings.

*Table 23-1: Limits of the project*

	Reference	Name	Ownership
North	010113319	Tambopata 17	Minera Peñaroles de Peru SAC
	010193216	Tambopata 4	Minera Peñaroles de Peru SAC
	010193316A	Tambopata 6T	Minera Peñaroles de Peru SAC
	010078118	Tambopata 12	Minera Peñaroles de Peru SAC
East	010345807	Chabela 1	TECK PERU S.A.
South	010180716	Millococha 2016 V	Mariano Pacheco Ortiz
	010180816	Millococha 2016 VI	Mariano Pacheco Ortiz
	010181216	Sansil 2016	Mariano Pacheco Ortiz
	010180616	Millococha 2016 I	Mariano Pacheco Ortiz
	010180016	Heraldos Negros 2016-II	Mariano Pacheco Ortiz
West	010180516	Millococha 2016 IV	Mariano Pacheco Ortiz
	010199120	Carisla 01	Anglo American Peru SA



approximately US\$20 million and the capital investment was recovered during its first year of production. Up to March 2017 it had produced 280,184 ounces of gold. Projected gold production is set at an average 21,000 ounces per annum through to 2022.

The Corihuarmi Mine is located at the northern extreme of the southern Peru Au-Ag epithermal belt. Mineralization is of a high-sulphidation (HS) epithermal type hosted in volcanic rocks close to the Chonta fault, a regionally significant north-northwest trending structure. The Chonta fault is a major geological break which separates Cenozoic volcanic deposits from folded Paleozoic sediments. Zoned alteration and mineralization is centred on dacitic and rhyodacitic domes intruded close to the Chonta Fault at its intersection with subordinate northeast faults (Seers et al., 2018).

### ***23.2.2 Heraldos Negros Mine***

The Heraldos Negros underground mine has been working an intrusive-related skarn and replacement deposit for about 50 years and is owned by Compañía Minera San Valentin S.A. a private Peruvian company.

## **23.3 Other Exploration Targets**

About 12 to 15 km south of the Bethania mine, Inca Minerals Limited is successfully exploring a number of geophysical anomalies (Cunajhuasi, Cuncayoz and Huasijaja) comprising Inca's Riqueza "flagship" project, located within the southerly trend of the epithermal belt. Within these explorations, we have Carmelitas and Tres Banderas 05 as target explorations. This project is now optioned to South32 for a 60% earn-in by spending US\$9.0 million over the next four years.

## 24 OTHER RELEVANT DATA AND INFORMATION

---

There is no other relevant data and information.

## 25 INTERPRETATION AND CONCLUSIONS

### 25.1 Geology and Mineral Resources

- The maiden MRE is supported by a database that consists of a total of 37 surface drill holes, with a total of 3,738 core assays (including QA/QC samples), and 608 historic underground channel samples.
- The QPs have reviewed the drilling, logging, and sampling, quality assurance-quality control, analytical and security procedures for the 2021 drilling program and concluded that all the data capture procedures are industry standard, and that the subsequent management of the exploration data meets strict data handling criteria.
- The QPs are of the opinion that the protocols in place are adequate and in general, to industry standards. The database for the Bethania Silver Project is of good overall quality and is appropriate for the purposes of the Mineral Resource Estimation. The measured density of the host veins and associated rock units, and sampling density, allows for a reliable estimate to be made of the size, tonnage, and grade of the mineralization in accordance with the level of confidence established by the Mineral Resource categories in the CIM Definition Standards (CIM, 2014).
- The Maiden Mineral Resource Estimate for the Project has been completed on the Bethania Project using all available information and data (Table 25-1). The Mineral Resources for the Project were classified in accordance with the most current CIM Definition Standards (CIM, 2014).
- In order to determine the quantity of mineralization that shows a “reasonable prospect for eventual economic extraction” using underground mining methods, QP Simon Mortimer, generated two block models, the first being a sub-blocked model based on the geometries of the mineralised structures and the second being a regularised block model with block size based on a minimum mining width of 0.6m. The material that shows a reasonable prospect for eventual economic extraction was determined using the regularized block model, applying a cut-off of 100 ppm silver equivalent, which was based upon the based an evaluation of current mining and processing costs. The final resource estimation statement also considered the material in the upper levels that had already been extracted and the material that could not be mined due to safety concerns.

*Table 25-1: Maiden Mineral Resource Estimate Statement, Bethania Silver Project, Peru*

Category	Tonnage	GRADE						CONTAINED METAL	
		Ag	Pb	Zn	Au	Cu	AgEq	Ag	AgEq
		(g/t)	(%)	(%)	(g/t)	(%)	(g/t)	(oz)	(oz)
Indicated	404,000	332	2.63	1.95	0.26	0.16	451	4,317,540	5,858,521
Inferred	700,000	249	2.51	1.58	0.24	0.12	356	5,600,256	8,006,431

- It is the opinion of the QPs that the Maiden MRE, completed in accordance with the requirements of the NI 43-101, reasonably reflects the mineralization that is currently known on the Bethania Silver Project and that there are reasonable prospects for future economic extraction, likely using narrow vein underground mining methods.
- The Mineral Resources are not mineral reserves and do not have demonstrated economic viability. The estimate is categorized as Inferred, Indicated and Measured resources based on data density, geological and grade continuity, search ellipse criteria, drill hole density and specific interpolation parameters. The Effective Date of the mineral resource estimates is 10 December 2021, based on the drill hole data compilation status and cut-off grade parameters.

## 25.2 Mining and Mine Plan

- Mr. Edgard Vilela, (BA Mining Engineering, MAusIMM (CP)) considers that conventional cut and fill (“OCF”) with waste fill is the optimal mining method for the mineralization reported at the Property.
- Mr. Edgard Vilela notes that mineralization reported at the Property is typical for narrow veins, and OCF successfully applied to numerous mines with mineralization with a similar geometry.
- Each mining block is made up of chimneys at the ends, a pass/escape way in the central part, a sub-level in the first cut of the block and a base drive that runs along the mineralized structure. The mining is ascending, and the filling will be carried out by means of excavations (filling with waste from the hanging wall).
- The mining plan contemplates the extraction of the mineralized material with the highest economic value in the first years, considering that the extraction panels are accessible (complete with development and preparation) through the mine entrances declared in the Environmental Impact Statement (DIA), then the plan It develops towards the areas of lower value progressively.
- The extraction of mineralized material is projected to be carried out by the Nv 670 for the higher zones (levels above the Nv. 670) and the inclined shaft will be used for the lower zones (levels below the Nv. 670).
- Filling of stopes will be carried out with waste generated by the advances (at the beginning) and will be complemented with slashing typical of the mining method.
- The mine is in the process of rehabilitation, and as such it is projected to have accessibility to areas of with the best value mineralized material value from the pre-production stage (last 6 months of year 0) where average grades of 12.31 oz/t.
- The mining plan reaches a production of 350 tpd from year 1 and is maintained until year 6, reducing its production rates for year 7 considering the economic mineralized material.



- For the mining plan, indicated and inferred mineralized material has been considered, where 36% of the total mineralized material considered in the plan is indicated material and 64% is inferred material.
- Total tonnes to be mined was estimated to be 857,078 tonnes over the life of mine (including the Toll-Milling Option)
- Mining recovery of 95%, mine dilution varies between 3.3% and 16.4% depending on stope width.
- 70% of the stopes are between 0.6 - 1 meters of mining width, 10% of stopes are between 1.0 - 1.2 meters, 12% of are between 1.2 - 2 meters and 8% of stopes are between 2 - 5.1 meters.
- Average production over the mine life from the three vein systems: 12 de Mayo at 100 tpd, Española at 153 tpd, and Victoria at 97 tpd.
- Mine development over the mine life is planned to be 27,428 metres, including 2,154 metres prior to the plant start-up and 5,491 metres in the first full year.

### 25.3 Metallurgy and Mineral Process Design

- The test work is appropriate for a PEA level study.
- Flotation tests have been completed in by an industrial laboratory at a level consistent with standard industry accepted practice.
- Based on the sample tested, the Santa Elena material can be ranked as medium hardness.
- The plant design follows modern conventional practice.
- The Bethania concentrator plant will have a capacity to process 350 MTPD of mineralized material with average head grades of 0.3% Cu, 4.0% Pb and 3.0% Zn, to produce lead concentrate and zinc concentrate.

### 25.4 Project Infrastructure

- The level of detail is sufficient for a PEA level study.
- The layout and engineering work done to date was undertaken to support the permitting process. Kuya took a strategic decision in selecting a 350 tpd process capacity when they started the permitting process as this was the maximum allowable tonnage permissible for a small mining producer, which Kuya was when they applied for the EIAsd. Kuya also took the strategic decision to initially do more technical and design work than what would normally be required for an EIAsd submission. The objective of this was to cut the transition time from basic to detailed engineering and reduce potential layout changes.
- Some of the studies, plans and technical assumptions used for engineering and layout design of the process plant and TSF may change, however from a permitting perspective having an initial design and approved Beneficiation Concession area, lends well for



receiving approval for future environmental instrument modifications which do not contain a greater environmental impact than those already permitted.

- The downside of an early permitting process may restrict changes to the future mine design.

#### **25.4.1 Tailings**

- The cost estimates were based on material take-offs and preliminary cost estimates as provided by a qualified earthworks contractor. As such, these are considered to be sufficiently accurate at PEA level. The quantity take-offs and the unit price build-ups were verified at PEA level only.
- It is noted that the proposed construction concept of excavation to create storage capacity, and especially in rock, is generally considered to be highly variable in terms of both cost and schedule. As such, given the balancing factors of the favorable level of costing detail, but also the uncertainty of the cost review and construction concept, the 25% contingency is considered to be acceptable.

### **25.5 Operating and Capital Cost Estimates**

#### **25.5.1 Operating Cost Estimates**

- Energy and labor costs tend not to change significantly, but recent increases in transportation costs (increased fuel costs) may affect the cost of plant inputs.
- The operating costs are within the standard of neighboring operations for the scale of production defined in the project, considering that it will be a conventional mining.
- The operating costs are considered acceptable at PEA level.

#### **25.5.2 Capital Cost Estimates**

- Since the mine already has a history of production, the investment in accesses and material transport routes will consist of rehabilitation.
- The initial CAPEX the project is relatively low due to the fact that it has mining and surface infrastructure, which require only rehabilitation.
- The capital costs for the mining were established with the assistance of benchmarking cost (similar operations).
- During the pre-production stage, the mining of accessible areas has been considered. This allows for the generation of cashflow during year 0, and thereby reduces the impact of the initial CAPEX of the project. As such, it is important to have the mine rehabilitated and accessible from month 7 of the pre-production year.

## 25.6 Financial Analysis

- The financial analysis has shown that the project offers positive results with a low upfront CAPEX requirement, and a fast payback period.
- Base case (\$25.40/oz silver price) Pre-Tax NPV (5%) of \$77.8 million and IRR of 227%.
- Base case (\$25.40/oz silver price) After-Tax NPV (5%) of \$54.7 million and IRR of 188%.
- Pre-production toll milling option would generate gross margin of \$9.5 million during construction at base case, would accelerate after-tax payback period to 0.50 years.
- After-tax cash flow of \$18.04 million in first full year of production (base case)
- Life of Mine ("LOM") after-tax free cash flow of \$65.3 million (base case).
- Initial Capital Cost Estimated at \$14.2 million plus 25% contingency of \$3.6 million.
- All-In Sustaining Costs of \$10.48/oz silver eq. in first year, \$12.15/oz silver eq. over LOM.
- Silver production of 1.37 million oz eq. in first year, 8.68 million oz eq. over LOM
- Production (head) grade of 13.8 oz/t (or 429 g/t) silver eq. in pre-production year, 10.1 oz/t (or 315 g/t) silver eq. over LOM.

### 25.6.1 Specific PEA Risks

- Risks and uncertainties which may reasonably affect reliability or confidence in future work on the Project relate mainly to the reproducibility of exploration results (*i.e.*, exploration risk) in a future production environment. Exploration risk is inherently high when exploring in epithermal polymetallic vein systems, however these risks are mitigated through the completion of surface geological and structural mapping, trenching, and sampling programs, high density (closely spaced drill holes) drilling programs, and when possible, by systematic sampling of underground mine workings that expose target vein systems.
- Aside from the recent change of government and related changes in policy, Peru's mining industry is highly regulated, and the permitting and reporting requirements for a mineral project can be complex, with several government agencies involved at different stages of development. As Kuya manages the permitting process for the Project, it may be required to delay and/or modify aspects or portions of the Project in order to meet all applicable requirements. These delays and/or changes to the Project could range in materiality from minor to significant.
- The PEA is not based on a feasibility study of mineral reserves, demonstrating economic and technical viability, and, as a result, there may be an increased uncertainty of achieving any particular level of recovery of minerals or the cost of such recovery, including increased risks associated with developing a commercially mineable deposit.
- Historically, such projects have a much higher risk of economic and technical failure. There is no guarantee that production will begin as anticipated or at all or that anticipated production costs will be achieved.

- Failure to commence production would have a material adverse impact on the Company's ability to generate revenue and cash flow to fund operations. Failure to achieve the anticipated production costs or revenue would have a material adverse impact on the Company's cash flow and future profitability.
- The proposed mine plan is based on a 36% indicated resources and 64% inferred resources. In order to reduce risk, the percentage of inferred resources, especially early on in the mine plan, should be reduced.
- The Authors are not aware of any other significant factors and risks that may affect access, title, or the right or ability to perform the proposed work program on the Project or the Property.

## 26 RECOMMENDATIONS

### 26.1 Geology and Mineral Resources

- It is the Authors’ opinion that additional exploration expenditures are warranted on the Bethania Silver Project and specifically the Property (Santa Elena concession). Future attention should also be given to the prospectively of the additional concessions the Company has acquired or applied for in the region (*i.e.*, Chinita I, Carmelitas, and Tres Banderas 01 to 07).
- With respect to the Bethania Mine, an underground drilling program should also be implemented (*see* details below). An underground drone (UAV) survey is also recommended.
- Given the completion of the Phase 1 diamond drilling program and the maiden Mineral Resource Estimate on the Mine Zone vein system of the Santa Elena concession, further exploration work should focus on proving the down dip extension of the mine zone vein system, the definition of the vein system in the Hilltop Zone, and the development of a project scale three-dimensional geological interpretation. Surface work should be completed for trenching, sampling, mapping (geological, alteration and structural) of Hilltop Zone vein system, followed up with a drilling program to confirm downdip extension on the veins. Drill hole parameters for a recommended surface diamond drilling program are provided in Table 26-1.
- Surface geophysical surveys such as induced polarization (chargeability/resistivity) and a high-resolution magnetic survey (possible drone based) are also recommended.

*Table 26-1: Recommended surface drilling program to test the Hilltop Zone vein system, Santa Elena concession.*

DDH	North	East	Z	DD_Station	Target	Angle	Azimuth	Length (m)
P1	443223	8603039	4854	1	Veta Daniela, Española2, Rocio & Mercedes	-45	22	230
P2	443223	8603039	4854	1	Veta Daniela, Española2, Rocio & Mercedes	-55	22	270
P3	443175	8603052	4869	2	Veta Daniela, Española2, Rocio & Mercedes	-45	22	270
P4	443175	8303052	4869	2	Veta Daniela, Española2, Rocio & Mercedes	-55	22	325
P5	443130	8603082	4856	3	Veta Daniela, Española2, Rocio & Mercedes	-50	22	260
P6	443130	8603082	4856	3	Veta Daniela, Española2, Rocio & Mercedes	-60	22	320
P7	443235	8603201	4823	4	Veta Santa Elena & Mercedes	-45	15	80
<b>Total 670 Level</b>								<b>1,755</b>

- It is recommended that as soon as a permit is granted to proceed with underground access and exploration, that the Company considers an underground exploration program to (1) verify historical sampling information, and (2) to probe the down dip continuation of the mineralised structures.

- These locations will then have to be increased in size, sufficient to accommodate diamond-drilling equipment within the drill bays. Where ground conditions are very poor it may not be necessary to use drill and blast, and shotcrete may have to be used to support temporary advances until the final excavation shape has been completed.
- The cost of the recommended underground 20-hole diamond drilling program, together with geological support, and the mining of 10 underground drill bays is summarised in Table 26-1. It should be noted that this is only approximate, as it is not currently possible to go underground and carry out a more detailed examination of the ground and working conditions that will be encountered.
- A breakdown of costs for a single phase recommended work program, surface and underground components, on the Santa Elena concession is detailed in the report titled “NI 43-101 Technical Report & Mineral Resource Estimate” by Caracle Creek International Consulting Inc. February 21st, 2022. These recommendations total approximately CAD\$2.2 million dollars.

## 26.2 Mining and Mine Plan

- It is recommended to carry out a 3D topographical survey of the existing levels (if they are accessible), to identify the upper levels that can be used for the mine design in later stages.
- Kuya Silver has the option to generate earlier revenues with a third-party processing facility in close proximity to the mine to ensure that revenue can be generated in year zero. The assumption used in the PEA is that third-party processing will occur in year zero. This assumption is material to the overall economics of the project and should be formalized.
- The proposed mine plan is based on a 36% indicated resources and 64% inferred resources. In order to reduce risk, the percentage of inferred resources, especially early on in the mine plan, should be reduced with further drilling.
- The mining plan considers that the rehabilitation will take place in the first 6 months of the pre-production year. This is a key point to reach the production rate of 350 tpd and should be prioritised.
- Detailed engineering is ongoing and is expected to cost approximately \$200,000.

## 26.3 Metallurgy and Mineral Process Design

- Develop a metallurgical testing program to confirm the process parameters and support the next phase of the Bethania project.
- Develop a closed-circuit metallurgical test program with regard to the mineralized structures of the deposit. The results of the tests will allow to estimate the metallurgical recovery for the life-of-mine (LOM) of the project.
- Perform rheological and sedimentation tests of tailings which will allow for confirmation of the preliminary design of the thickener and tails transport system.

- Costs for the metallurgical test program as described are approximately \$350,000.

## 26.4 Project Infrastructure

- In general, Kuya has obtained all the necessary operating permits (environmental certification, use of explosives, water use permit, among others), and also has the Environmental Impact Statement and its respective update, which address the identification of the environmental and social impacts caused by mining operations, providing environmental certification.
- In turn, the company has approved the Semi-detailed Environmental Impact Assessment (EIASd) for the processing plant, this environmental document includes the execution of participatory workshops through which the perceptions of the population were identified and the social impacts were evaluated.
- Finally, it is important to specify that, to date, Kuya has an agreement with the Farming Community of Poroche for the use of surface land, in which the community has committed to:
  - Maintain an adequate social environment that makes the development of the company's activities viable.
  - Not disturb the use of surface areas, accesses and roads that are required for the development of mining activities, allowing their free and peaceful use for their benefit.
  - Allow and facilitate the company or whoever it designates the transit and access to the surface land, granting it all the necessary facilities and allowing the construction of additional access roads to said surface land, if applicable.
  - Provide unskilled labor for detailed maintenance of mining activities and the company.
- Provide additional space within the Community for the construction and operation of the company's sedimentation ponds.

## 26.5 Tailings

- Excavation quantities, and unit prices should be reviewed, to analyze possible variations if actual conditions vary from those anticipated. Initial reviews indicate that there could be significant variation from design.
- Given that Kuya is a listed company, it is recommended that the 2020 Global Industry Standard for Tailings Management be followed as closely as possible. Initially, this would include a detailed review by an Independent Technical Reviewer.
- The design concept of excavation, primarily in rock, to create storage capacity is generally considered to be inefficient, and costly. It is recommended that, if time permits, other, more robust concepts be considered (if they have not been already). One such concept could be to produce dry, filtered tailings, to be stacked without the need for a significant confining structure, instead of a conventionally thickened tailings slurry.

## 27 REFERENCES

---

### Technical Report

- Bethania Silver Project, PERU, NI 43-101 Technical Report and Maiden Mineral Resource Estimate; Prepared by Caracle Creek; Effective Date 06 January 2022

### Technical Papers

- Y. Potvin, M. Hudyma, H.D.S. Miller (1988) The Stability Graph Method for Open Stope Design; University of British Columbia; Pages 1 – 28
- Bienawski, Z.T., 1989: Engineering Rock Mass Classifications – A Complete Manual for Engineers and Geologists in Mining, Civil, and Petroleum Engineering; a Wiley Interscience Publication.

### Consultant Reports

- Declaratoria de Impacto Ambiental, PERU, Modificación de la declaración de impacto ambiental – Categoría I para Pequeño Productor Minero Concesión Minera Santa Elena; Prepared by E. Soria; Effective Date 02 August 2020.
- Declaratoria de Impacto Ambiental, PERU, Actualización Declaratoria de impacto ambiental Concesión Minera Santa Elena; Prepared by O. Tinoco; Effective Date 02 November 2016.
- Discount Rate, Informe Tasa de Descuento; Prepared by Kuya Silver; Effective Date 07 March 2022.
- CAPEX – OPEX, Estimado de Costos Capatales y Operativos; Prepared by Kuya Silver; Effective Date 21 December 2021.
- Market, PERU, Bethania Concentrate Marketing Report; Prepared by Stonehouse Consulting Inc; Effective Date 19 November 2021.
- Modelo Económico – Cálculo de Impuestos, PERU, Informe Nro 001 - 2022; Prepared by José Manuel Baca Quiñonez; Effective Date 09 April 2022.
- Camprubí A. and Albinson T., 2006: Depósitos epitermales en México: actualización de su conocimiento y reclasificación empírica. Boletín de la Sociedad Geológica Mexicana, Volumen Conmemorativo del Centenario, Revisión de Agunas Tipologías de Depósitos Minerales de México. Tomo LVIII, No. 1, 2006, pp.27-81.
- Carrillo Rosúa, F.J., Morales Ruano, S., Boyce, A.J., and Fallick, A.E., 2003: High and intermediate sulphidation environment in the same hydrothermal deposit: the example of Au-Cu Palai-Islica deposit, Carboneras (Almería). En Eliopoulos D.G. et al., (eds.) Mineral exploration and sustainable development. Millpress, Rotterdam, pp.445-448.
- CIM, 2014: CIM Definition Standards for Mineral Resources & Mineral Reserves. Prepared by the CIM Standing Committee on reserve Definitions, Adopted May 2014, 10p.
- Corbett, G.J., 2007: Controls to low sulphidation epithermal Au-Ag mineralization. Unpublished paper on [www.corbettgeology.com](http://www.corbettgeology.com).
- Donayre, C. and Guzman, C., 2013: Informe tecnico visita Mina Santa Elena – Huancavelica. Trafigura Group Pte. Ltd., 11p.
- INGEMMET (2003). Boletín, Serie B: Geología Económica No. 12. Estudio de recursos minerales del Perú - Franja No. 3 (Boletín B12). Published by Instituto Geológico, Minero y Metalúrgico. Dirección de Geología Económica y Prospección Minera, 421p.



- Jobin-Bevans, S., 2019: National Instrument 43-101 Technical Report, Bethania Silver Project, Department of Huancavelica, Province of Huancavelica, District of Acobambilla, Peru; issued August 29, 2019, and with an Effective Date of July 31, 2019, 127p.
- Jobin-Bevans, S., Mount, M., Aymachoque, J., and Mortimer, S.J.A., 2003: Independent Technical Report on the Bethania Silver Project, Department of Huancavelica, Province of Huancavelica, District of Acobambilla, Peru, issued 29 September 2021 with an effective date of 15 September 2021, 169p.
- Landa, C. and Salazar, H., 1993: Geología de los cuadrangulos de mala, lunahuana, tupe, conayca, chinchá, tantara y castrovirreyna. En Boletín - Instituto Geológico, Minero y Metalúrgico. Serie A, Carta Geológica Nacional, Perú, 1993, v44, 118p.
- Morche, W. and Larico, W., 1996: Geología del cuadrangulo de huancavelica. En Boletín - Instituto Geológico, Minero y Metalúrgico. Serie A, Carta Geológica Nacional, Perú, v73, 180p.
- Milla, D., 2016a: (S&L Company Report) Mina Santa Elena Estimación de Recursos y Reservas Minerales, Marzo, March 2016, 16p.
- Milla, D., 2016b: (S&L Company Report) Geological Report (Summary) Carmelita Mine, February 2016, 9p.
- Milla, D. and Osorio, R., 2016: (S&L Company Report) Evaluacion Geologica Mina Santa Elena.
- Mount, M. and Pareja, L.D., 2020: Developments in Sensor Based Ore Sorting, and the Sampling, Testing and Feasibility Route to be taken in Metalliferous Mining. Virtual presentation in the 5th Conference on Relaves, Peru.
- Pendock, N., 2020: Exploration at the Bethania Silver Mine, Peru, using satellite visible/near infrared [VNIR], shortwave infrared [SWIR] and longwave infrared [LWIR] imagery; report and data (images), 16p.
- Rubio, E., Hastings, M., and Chung, A., 2018: NI 43-101 Preliminary Economic Assessment (PEA) for the Yauricocha Mine, Peru. Prepared for Sierra Metals Inc., 212p.
- Seers, D., Fowler, A., Espinoza, R., and Johnston, A., 2018: Updated NI 43-101 Technical Report Minera IRL Limited Corihuarmi Mine, Central Peru. Prepared for Minera IRL Limited, 181p.
- Sillitoe, R. and Hedenquist, J., 2003: Linkages between volcanotectonic settings, ore-fluid compositions, and epithermal precious-metal deposits. In Volcanic, geothermal, and ore-forming fluids: Rulers and witnesses of processes within the Earth, Edition: Special Publication 10, Chapter: 16, Publisher: Society of Economic Geologists, Editors: Simmons S.F., Graham I.J., pp.315-343.
- Soria, E., 2019: Company reports and summaries for production, property history and metallurgical test work – various.
- Stein, D., 2018: Exploration Potential of the Bethania Mine and Region. Kuya Silver Corporation, Internal Report (August 2018), 11p.
- Tuck, M., 2008: Resue firing and dilution control in narrow vein mining, in Narrow vein mining conference 2008, AusIMM, Ballarat.
- Wang, L., Qin, K-Z., Song, G-X., and MingLi, G., 2019: A review of intermediate sulfidation epithermal deposits and sub-classification. Ore Geology Reviews, v107, pp.434-456.
- Xishan, C., 1998: Resuing Shrinkage Stoping; a new approach to Mining Extremely Narrow Veins, in Engineering & Mining Journal, October 1998, v34.

- UCSC 2021a, PERU, Análisis de estabilidad física y filtraciones; Prepared by UCSC; Effective Date September 2021
- UCSC 2021b, PERU, Análisis dinámico de deformaciones; Prepared by UCSC; Effective Date October 2021
- UCSC 2021c, PERU, Criterio de diseño de depósito de relaves; Prepared by UCSC; Effective Date September 2021
- UCSC 2021d, PERU, Especificaciones técnicas Movimiento de tierra; Prepared by UCSC; Effective Date September 2021
- UCSC 2021e, PERU, Estimaciones de control depósito de relaves; Prepared by UCSC; Effective Date September 2021
- UCSC 2021f, PERU, Evaluación y selección de materiales de construcción; Prepared by UCSC; Effective Date September 2021
- UCSC 2021g, PERU, Manejo de agua de no contacto y balance de agua superficial; Prepared by UCSC; Effective Date September 2021
- UCSC 2021h, PERU, Memoria de estabilidad de dique; Prepared by UCSC; Effective Date September 2021
- UCSC 2021i, PERU, Zonificación del cuerpo del dique; Prepared by UCSC; Effective Date October 2021
- UCSC 2021j, PERU, Análisis de riesgo; Prepared by UCSC; Effective Date September 2021